

CC 3800-1

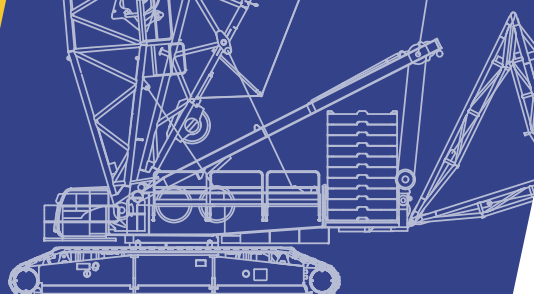



**Crawler Crane
650 t Capacity**



DEMAG[®]
TADANO GROUP

| Page · Seite · Page · Pagina · Página · Página · Страница: | |
|--|------|
| Specifications · Technische Daten · Caractéristiques · Dati tecnici · Datos técnicos · Especificações · Технические характеристики | 5 |
| Superlift configurations · Superlift-Konfigurationen · Combinaisons Superlift · Configurazioni Superlift · Configuraciones Superlift · Configurações do Superlift · Варианты конфигурации суперлифт..... | 9-10 |
| Specifications · Technische Daten · Caractéristiques · Dati tecnici · Datos técnicos · Especificações · Технические характеристики | 10 |
| Erection / lowering · Aufrichten / Ablegen · Monter / déposer · Montaggio / calata · Erección / descenso · Levantamento / descida · Подъем/опускание..... | 12 |
| Boom combinations · Ausleger-Kombinationen · Combinaisons de flèche · Combinazioni braccio · Combinaciones de pluma · Combinações de lanças · Комбинации стрелы | 14 |
| Main boom · Hauptausleger · Flèche principale · Braccio base · Pluma principal · Lança principal · Главная стрела (SH, LH) | 22 |
| Main boom with SL · Hauptausleger mit SL · Flèche principale avec SL · Braccio base con SL · Pluma principal con SL · Lança principal com SL · Главная стрела с SL (SSL, LSL)..... | 30 |
| Fixed fly jib · Starrer Hilfsausleger · Fléchette fixe · Falcone fisso · Plumín fijo · Lança auxiliar fixa · Неподвижная стрела с изменяемым вылетом (SH+LF, LH+LF)..... | 48 |
| Fixed fly jib with SL · Starrer Hilfsausleger mit SL · Fléchette fixe avec SL · Falcone fisso con SL · Plumín fijo con SL · Lança auxiliar fixa com SL · Неподвижная стрела с изменяемым вылетом с SL (SSL+LF) | 64 |
| Fixed fly jib with SL · Starrer Hilfsausleger mit SL · Fléchette fixe avec SL · Falcone fisso con SL · Plumín fijo con SL · Lança auxiliar fixa com SL · Неподвижная стрела с изменяемым вылетом с SL (LSL+LF) | 78 |
| Luffing fly jib · Wippbarer Hilfsausleger · Fléchette à volée variable · Falcone a volata variabile · Plumín abatible · Jib de lance variável · Стрела с изменяемым углом вылета и гуськом (SW) | 120 |
| Luffing fly jib with SL · Wippbarer Hilfsausleger mit SL · Fléchette à volée variable avec SL · Falcone a volata variabile con SL · Plumín abatible con SL · Jib de lance variável com SL · Стрела с изменяемым углом вылета и гуськом с SL (SWSL / SFSL)..... | 140 |
| Fixed fly jib with SL · Starrer Hilfsausleger mit SL · Fléchette fixe avec SL · Falcone fisso con SL · Plumín fijo con SL · Lança auxiliar fixa com SL · Неподвижная стрела с изменяемым вылетом с SL (LVSL) | 180 |
| Technical description · Technische Beschreibung · Descriptif technique · Descrizione tecnica · Descripción técnica · Descrição técnica · Техническое описание..... | 184 |

Zeichenerklärung · Légende · Leggenda · Leyenda · Legenda · Условные обозначения

| | | | |
|---|--|---|---|
|  | Track · Spur · Voie · Cingolo · Orugas · Esteira · Колея | „D“ |  |
|  | Counterweight + central ballast (ZB) · Gegen- gewicht + Zentralballast (ZB) · Contrepoids + lest central (ZB) · Contrappeso + zavorra centrale (ZB) · Contrapeso + lastre central (ZB) · Contrapeso + lastro central (ZB) · Противовес + центральный балласт (ZB) | S: | heavy · schwer · lourd · pesante · pesado · pesada · сильный |
|  | Superlift counterweight · Superlift-Gegengewicht · Contrepoids Superlift · Contrappeso Superlift · Contrapeso Superlift · Contrapeso do Superlift · Противовес суперлифт | L: | light · leicht · léger · leggera · ligero · leve · слабый |
|  | Superlift radius · Superlift-Radius · Rayon Superlift · Sbraccio Superlift · Radio de Superlift · Raio do Superlift · Радиус для оборудования суперлифт | H / HA: | Main boom · Hauptausleger · Flèche principale · Braccio principale · Pluma principal · Lança principal · Главная стрела |
|  | Possible load of hook block · Mögliche Traglast Unterflasche · Charge possible de crochet-moufle · Portata possibile di bozzello · Carga permitida de gancho · Carga possível do moitão · Допустимая нагрузка на крюкоблок | HI: | Luffing jib · Hilfsausleger · Fléchette · Falcone · Plumín · Lança auxiliar · Стрела с изменяемым вылетом |
|  | Weight of hook block · Gewicht Unterflasche · Poids de crochet-moufle · Peso di bozzello · Peso de gancho · Peso do moitão · Вес крюкоблока | MA: | Mast · Mast · Mât · Montante · Mástil · Mastro · Мачта |
|  | Load radius · Lastradius · Portée · Raggio di lavoro · Radio de trabajo · Raio de operação · Рабочий радиус | W: | Luffing fly jib · Wippbarer Hilfsausleger · Fléchette à volée variable · Falcone a volata variabile · Plumín abatible · Jib de lance variável · Стрела с изменяемым углом вылета и гуськом |
|  | Main boom · Hauptausleger · Flèche principale · Braccio principale · Pluma principal · Lança principal · Главная стрела | F: | Fixed fly jib · Starrer Hilfsausleger · Fléchette fixe · Falcone fisso · Plumín fijo · Lança auxiliar fixa · Неподвижная стрела с изменяемым вылетом |
|  | Fly jib · Hilfsausleger · Fléchette · Falcone · Plumín · Lança auxiliar · Стрела с изменяемым вылетом | SL: | Superlift · Superlift · Levage supplémentaire · Superlift · Superlift · Kit Superlift · Суперлифт (система для увеличения грузоподъемности) |
|  | Main boom angle · Hauptauslegerwinkel · Jarret de flèche principale · Inclinazione braccio base · Ângulo de pluma principal · Ângulo da lança principal · Угол наклона главной стрелы | V: | Vessellift · Vessellift · Vessellift · Vessellift · Vessellift · Içamento de embarcação · Подъем судов |
|  | Fly jib angle · Hilfsauslegerwinkel · Jarret de fléchette · Inclinazione falcone · Ângulo de plumín · Ângulo da lança auxiliar · Угол наклона стрелы с изменяемым вылетом |  | Central ballast · Zentralballast · Lest central · Zavorra centrale · Lastre central · Lastro central · Центральный балласт |
|  | Wind speed in m/s (meter per second) · Wind- geschwindigkeit in m/s · Vitesse du vent en m/s · Velocità del vento in m/s (metri al secondo) · Velocidad del viento en m/s · Velocidade do vento em m/s (metros por segundo) · Скорость ветра в м/сек | | |
|  | Track shoe width · Kettenbreite · Largeur des tuiles · Larghezza cingolo · Ancho de la zapata de la oruga · Largura da sapata da esteira · Ширина звена гусеницы | | |

- ▶ 650 t at 12 m radius
 - ▶ Load moment of 9152 tm
 - ▶ Fall protection as standard
 - ▶ Erection of main boom 114 m with 12 m LF and hook block mounted: without superlift mast and without assist crane
 - ▶ Erection of wind turbines up to **170 m** hub height with superlift, up to 110 m hub height without superlift
 - ▶ Best in class ergonomics for operator
 - ▶ Suitable for worldwide operation
- ▶ 650 t Tragfähigkeit bei 12 m Radius
 - ▶ Max. Lastmoment 9152 mt
 - ▶ Absturzsicherung serienmäßig
 - ▶ Aufrichten des 114 m Hauptauslegers mit angebautem 12 m LF und Haken ohne Superliftmast und ohne Hilfskran
 - ▶ Errichtung von Windturbinen mit einer Nabenhöhe von bis zu **170 m** mit Superlift bzw. bis zu 110 m ohne Superlift
 - ▶ Bedienerergonomie der Spitzenklasse
 - ▶ Für weltweiten Einsatz konzipiert
- ▶ 650 t à 12 m de rayon
 - ▶ Moment de charge de 9152 tm
 - ▶ Protection anti-chute en série
 - ▶ Montage de la flèche principale de 114 m avec 12 m LF et crochet moufle montés : sans mât superlift et sans grue auxiliaire
 - ▶ Installation d'éoliennes avec Superlift pour celles dont le moyeu atteint **170 m** de haut et sans Superlift pour celles dont le moyeu atteint 110 m de haut
 - ▶ Ergonomie optimale du poste de conduite
 - ▶ Conçue pour une utilisation dans le monde entier
- ▶ Portata di 650 t entro 12 m
 - ▶ Momento di carico di 9152 tm
 - ▶ Protezione anticaduta di serie
 - ▶ Braccio 114 m configurabile con LF 12 m e bozzello montati: senza superlift e senza gru ausiliaria
 - ▶ Montaggio di turbine eoliche con altezza del mozzo fino a **170 m** con Superlift; con altezza del mozzo fino a 110 m senza Superlift
 - ▶ Comandi ergonomici di prim'ordine per il comfort dell'operatore
 - ▶ Concepita per l'uso internazionale
- ▶ 650 t para radio de 12 m
 - ▶ Momento de carga máx. 9152 tm
 - ▶ Protección contra caídas de serie
 - ▶ Erección de pluma principal 114 m con LF de 12 m y bloque de gancho montado: sin mástil superlift ni grúa auxiliar
 - ▶ Montaje de turbinas eólicas de hasta **170 m** de altura de eje con Superlift y de hasta 110 m de altura de eje sin Superlift
 - ▶ Mejor ergonomía para el operador de su clase
 - ▶ Adecuada para operaciones a nivel mundial
- ▶ 650 t com 12 m de raio
 - ▶ Momento de carga de 9152 t
 - ▶ Proteção contra quedas de série
 - ▶ Montagem de lança principal de 114 m com auxiliar de 12 m e moitão instalados; sem mastro do superlift e sem guindaste de apoio
 - ▶ Montagem de turbinas eólicas até **170 m** de altura do cubo com Superlift, até 110 m de altura do cubo sem Superlift
 - ▶ Ergonomia inigualável para o operador
 - ▶ Recomendado para operação no mundo inteiro
- ▶ 650 т при радиусе 12 м
 - ▶ Грузовой момент 9152 тм
 - ▶ Защита от падения с высоты в стандартной
 - ▶ Высота главной стрелы 114 м с вспом. стрелой LF длиной 12 м и установленным крюкоблоком: без мачты суперлифт
 - ▶ Установка ветрогенераторов с высотой до ступицы ветроколеса до **170 м** с использованием системы Superlift, и с высотой до ступицы 110 м без использования системы Superlift
 - ▶ Лучшая к классе эргономика для оператора
 - ▶ Пригоден для использования в любой стране мира

Specifications

CC 3800-1

Technische Daten · Caractéristiques · Dati tecnici ·
Datos técnicos · Especificações · Технические характеристики

**Working speeds (infinitely variable) · Arbeitsgeschwindigkeiten (stufenlos regelbar) ·
Vitesses de travail (réglables sans paliers) · Rapporti di lavoro (a regolazione continua) ·
Velocidades de trabajo (progresión continua) · Velocidades de trabalho (infinitamente
variáveis) · Рабочие скорости (с бесступенчатой регулировкой)**

| Mechanism Antrieb Mécanisme Funzioni Mecanismos Mecanismo Механизм | Rope ø Seil-ø ø du câble ø fune ø cable Diâm. cabo Диаметр троса | Speeds ¹⁾ Geschwindigkeiten ¹⁾ Vitesses ¹⁾ Rapporti ¹⁾ Velocidades ¹⁾ Velocidades ¹⁾ Скорости ¹⁾ | Single line pull Seilzug je Strang Effort sur brin simple Tiro fune singolo Tracción de cable simple Tração de linha simples Тяговое усилие на одиночном тросе | Length of hoist rope Länge des Hubseils Longueur du câble de levage Lungh. della fune dell'argano Long. de cable de cabrestante Compr. do cabo do guincho Длина троса |
|--|---|---|---|---|
| Hoist I+II · Hubwerk I+II · Treuil de levage I+II · Agano I+II · Cabrestante I+II · Guincho I+II · подъем I+II | (H1+H2) 28 mm | max. 130 m / min | 180 kN | 1000 m |
| Hoist III · Hubwerk III · Treuil de levage III · Agano III · Cabrestante III · Guincho III · подъем III | (H3) 28 mm | max. 80 m / min | 180 kN | 650 m |
| Boom derricking · Wippwerk Hauptausleger · Variation de flèche · Inclinazione del braccio · Descenso de pluma · Inclinação da lança · Подъем стрелы деррик-краном | (W2) 28 mm | max. 130 m / min | | |
| Boom hoist · Einziehwerk · Relevage de flèche · Argano del braccio · Cabrestante de pluma · Guincho da lança · Подъем стрелы | (E) 28 mm | max. 125 m / min | | |
| Jib luffing · Wippwerk Hilfs- ausleger · Variation de volée · Sollevamento del braccio · Abatimiento de plumín · Inclinação da lança auxiliar · Изменение вылета стрелы | (W1) 28 mm | max. 120 m / min | | |
| Slewing (rpm) · Drehwerk (U / min) Orientation (tr / mn) · Rotazione (rpm) · Unidad de giro (rpm) · Giro (rpm) · Поворот (rpm) | | 0-1 | | |

¹⁾ top layer · oberste Lage · couches supérieure · avvolgimento superiore · capa superior · camada superior · верхний слой

**Carrier performance · Fahrleistungen · Performances du porteur ·
Prestazioni del carro · Rendimiento del vehículo · Desempenho do veículo ·
Общие характеристики шасси**

Travel speed · Fahrgeschwindigkeit · Vitesses de translation · Velocità di marcia ·
Velocidad de desplazamiento · Velocidade de marcha · Скорость движения

max. 1,1 km/h

Specifications

CC 3800-1

Technische Daten · Caractéristiques · Dati tecnici ·

Datos técnicos · Especificações · Технические характеристики

Hook block system · Unterflaschensystem · Système de crochet-moufle · Sistema per bozzello · Sistema de bloque de gancho · Sistema de moitão · Система крюкоблока

| Type Typ Type Tipo Tipo Tipo Тип | Possible load Mögliche Traglast Charge possible Portata possibile Carga permitida Carga possível Допустимая нагрузка | Number of sheaves Anzahl der Rollen Nombre de poulies Numero di pulegge Total de poleas Número de polias Количество шкивов | Number of lines Strangzahl Nombre de brins No max avvolgim. Reenvíos máx. Número de cabos Кратность троса | Weight Gewicht Poids Peso Peso Peso Вес | „D“ |
|--|--|--|---|---|-------------------------------|
| 2 x 325 | 650 t 380 t | 4 x 5 1 x 10 | 2 x 20 1 x 21 | 10,1 t – 13,2 t 7,3 t – 11,3 t (3,8 t – 11,0 t*) | 5,60 m 5,60 m (4,90 m*) |
| 2 x 190 | 380 t | 2 x 5 | 2 x 11 | 7,3 t – 11,3 t (3,8 t – 11,0 t*) | 5,90 m (4,90 m*) |
| | 190 t | 1 x 5 | 1 x 11 | 6,2 t (2,7 t – 4,8 t*) | 5,90 m (5,20 m*) |

* with optional equipment 400 t hook or 200 t hook · mit optionalem 400 t Haken oder 200 t Haken · avec équipement optionnel: crochet de 400 t ou crochet de 200 t hook · con gancio opzionale da 400 t o 200 t · con equipamiento opcional, gancho 400 t o 200 t · com gancho de 400 t ou 200 t como equipamento opcional · с опциональным крюком 400 т или 200 т

Double hook block · Doppel-Unterflasche · Crochet-moufle double · Doppio bozzello · Bloque de gancho doble · Moitão duplo · Крюкоблок с двурогим крюком

| Type Typ Type Tipo Tipo Tipo Тип | Possible load Mögliche Traglast Charge possible Portata possibile Carga permitida Carga possível Допустимая нагрузка | Number of sheaves Anzahl der Rollen Nombre de poulies Numero di pulegge Total de poleas Número de polias Количество шкивов | Number of lines Strangzahl Nombre de brins No max avvolgim. Reenvíos máx. Número de cabos Кратность троса | Weight Gewicht Poids Peso Peso Peso Вес | „D“ |
|--|--|--|---|---|--------|
| 2 x 90 | 178 t | 2 x 2 | 2 x 5 | 2,3 t – 8,9 t | 4,50 m |

Hook block · Unterflasche · Crochet-moufle · Bozzello · Bloque de gancho · Moitão · Крюкоблок

| Type Typ Type Tipo Tipo Tipo Тип | Possible load Mögliche Traglast Charge possible Portata possibile Carga permitida Carga possível Допустимая нагрузка | Number of sheaves Anzahl der Rollen Nombre de poulies Numero di pulegge Total de poleas Número de polias Количество шкивов | Number of lines Strangzahl Nombre de brins No max avvolgim. Reenvíos máx. Número de cabos Кратность троса | Weight Gewicht Poids Peso Peso Peso Вес | „D“ |
|--|--|--|---|---|--------|
| 125 | 123,5 t | 1 x 3 | 1 x 7 | 1,8 t – 5,1 t | 4,60 m |
| 54 | 54 t | 1 x 1 | 1 x 3 | 1,1 t – 3,3 t | 4,50 m |
| 18* | 18 t | – | 1 x 1 | 1,1 t | 3,90 m |

* Single line hook / Hakengehänge / Boulet / Gancio singolo / Gancho simple / Gancho para linha singela / Крюк на одиночном тросе

Specifications

CC 3800-1

Technische Daten · Caractéristiques · Dati tecnici ·

Datos técnicos · Especificações · Технические характеристики

Basic crane dimensions · Hauptabmessungen · Dimensions de la grue de base ·

Dimensioni di base della gru · Dimensiones básicas de la grúa · Dimensões do guindaste básico · Базовые габариты крана

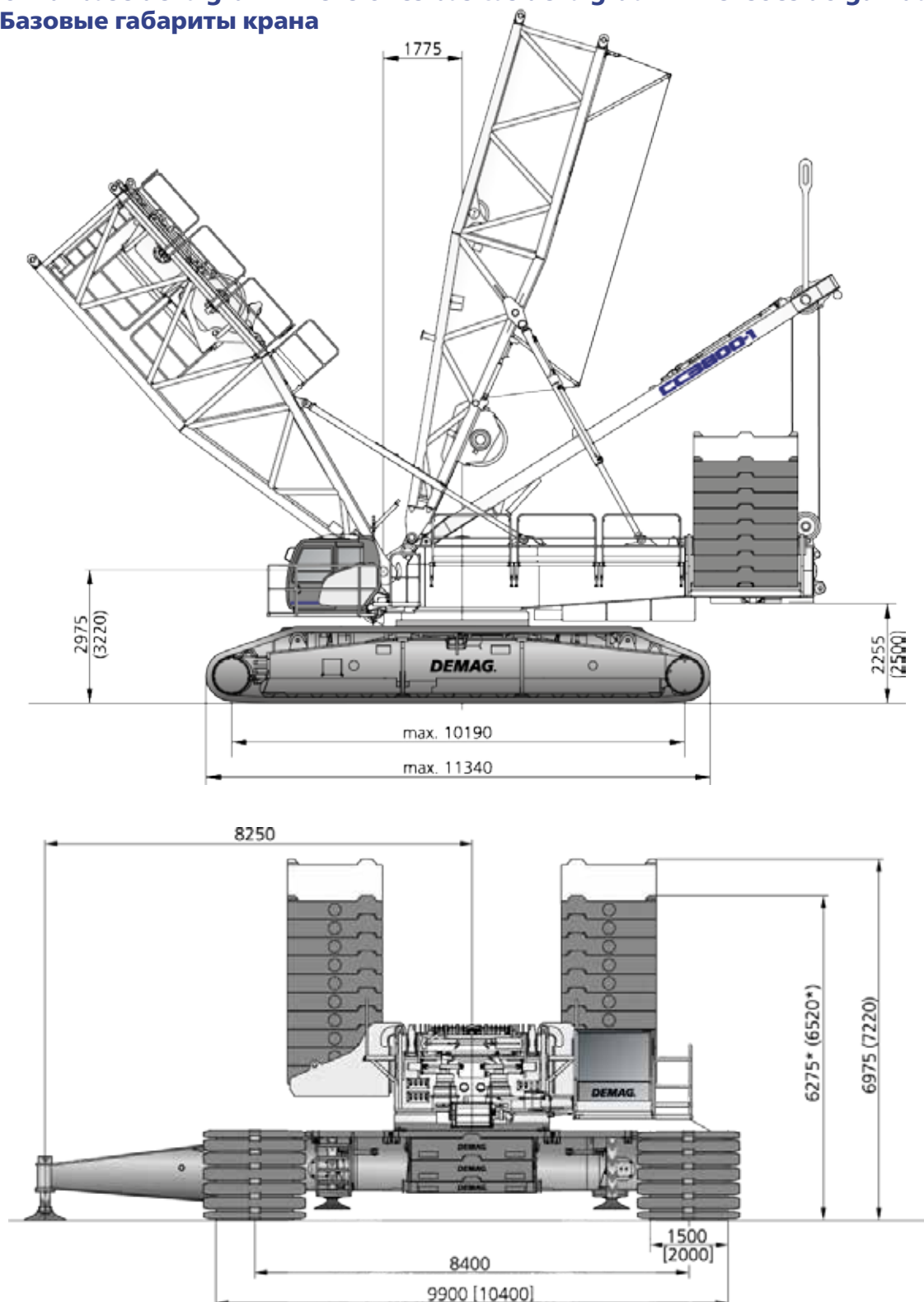

() with optional quick-connection · mit optionaler Schnellverbindung · avec système d'attache rapide en option · con attacco rapido opzionale · con conexión rápida opcional · com engate rápido opcional · Опция: быстроразъемное соединение

[] Option · Option · En option · Opzione · Opcion · Opcional · Опция

* Optional cast iron · Stahlguss optional · Fonte en option · In ghisa, opzionale · Opcionalmente: hierro fundido · Opcional ferro fundido · По выбору клиента из чугуна

Specifications

CC 3800-1

Technische Daten · Caractéristiques · Dati tecnici ·
Datos técnicos · Especificações · Технические характеристики

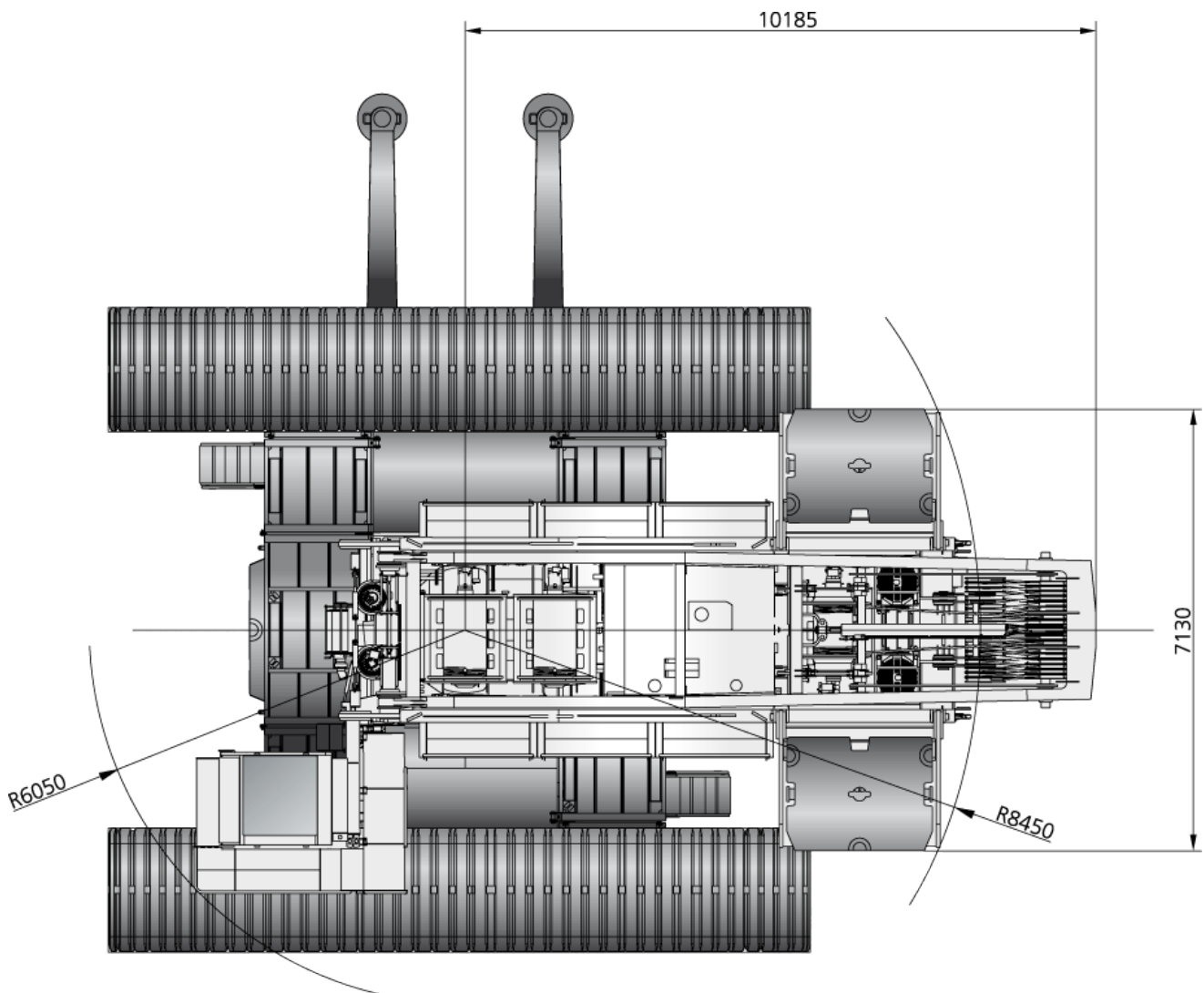

Superlift Configurations

CC 3800-1

Superlift-Konfigurationen · Combinaisons Superlift ·
 Configurazioni Superlift · Configuraciones Superlift ·
 Configurações do Superlift · Варианты конфигурации суперлифт

SL 0 t 9 m

R 9 m

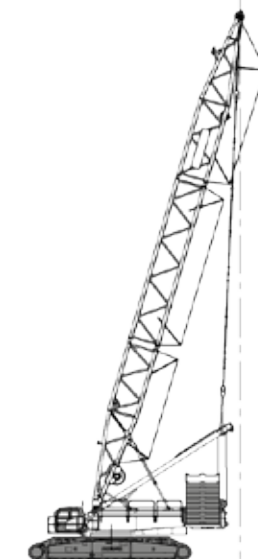

SL-Mast 36 m Standard-SL

R 11.5 15.5 19.5m

13.5 17.5

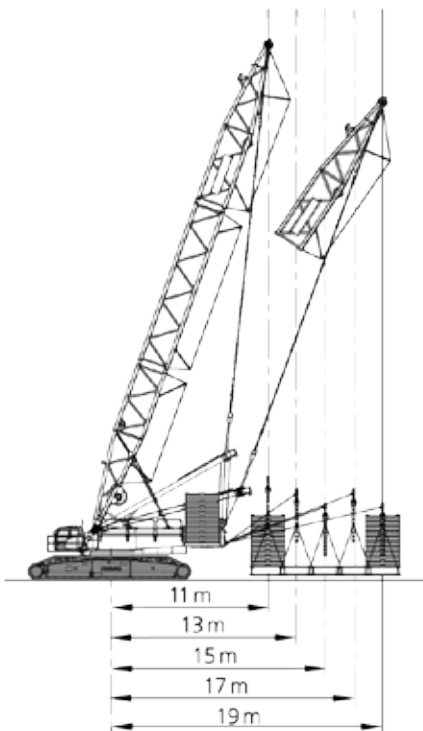

Vario-SL 11-19 m

R 11.5 - 19.5m

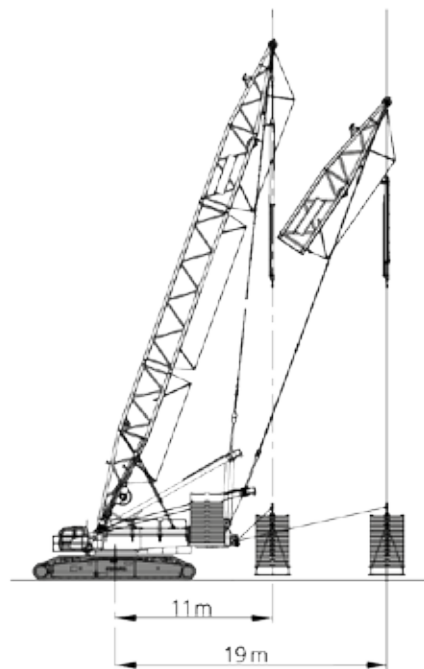

SL-Mast 36 m

SL Carrier · SL-Wagen · Châssis SL · Carro SL · Carro SL · Veículo do SL · Шасси SL

13-17 m

R 15.75 m

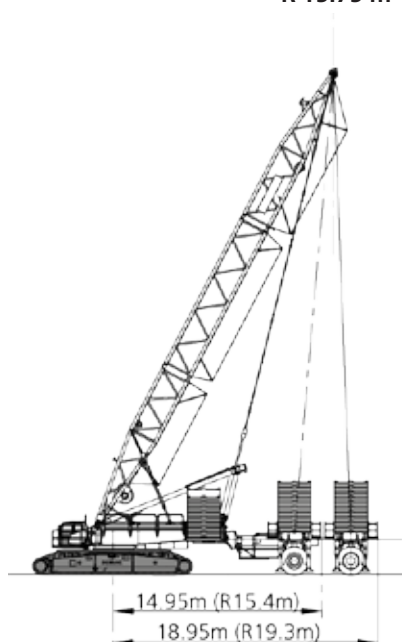

15-19 m

R 15.75 m

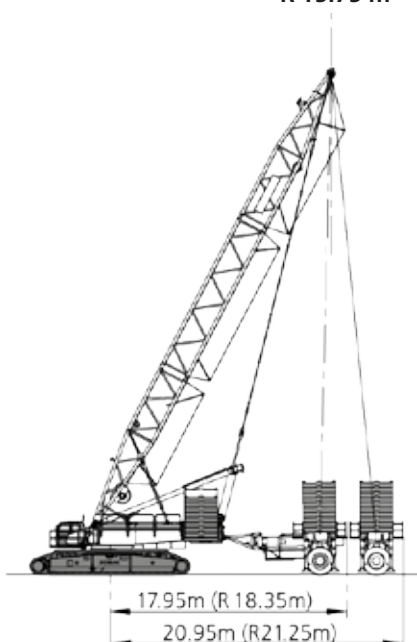

SL-Mast 39.5 m & 42 m

Flex Frame 13-21 m

R 13.75 m

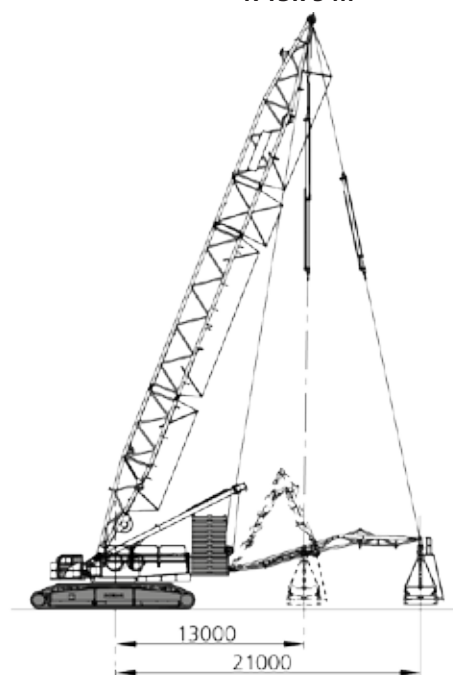

Alternatively, the telescope connector may be used in combination with the Superlift Tray · Alternative Verwendung der Teleskopverbindung mit dem Superlift-Tray ist möglich · Vous pouvez également utiliser un connecteur télescopique avec le plateau SuperLift Tray · In alternativa, può essere utilizzato il cilindro di sfilo in combinazione con il supporto Superlift · Alternativamente se puede utilizar el conector telescópico en combinación con la bandeja Superlift · Como alternativa, o conector do telescópio pode ser usado em combinação com a Base do Superlift · В качестве альтернативы может использоваться телескопический соединитель в сочетании с платформой для противовесов Superlift

Superlift Configurations

CC 3800-1

Superlift-Konfigurationen · Combinaisons Superlift ·
 Configurazioni Superlift · Configuraciones Superlift ·
 Configurações do Superlift · Варианты конфигурации суперлифт

SL-Mast 39.5 m

Vario-SL 11-21 m

R 11.5 - 21.5 m

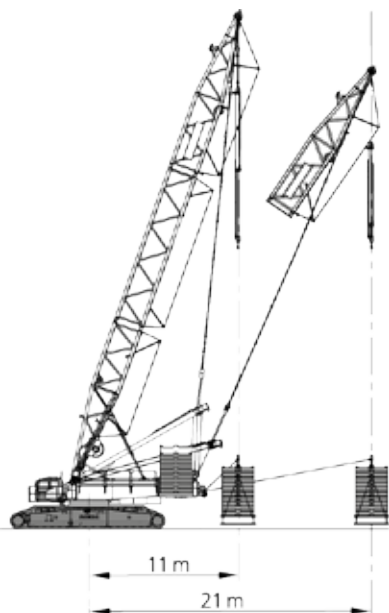

SL Carrier · SL-Wagen · Châssis SL · Carro SL · Carro SL · Veículo do SL · Шасси SL

R 13.75 m

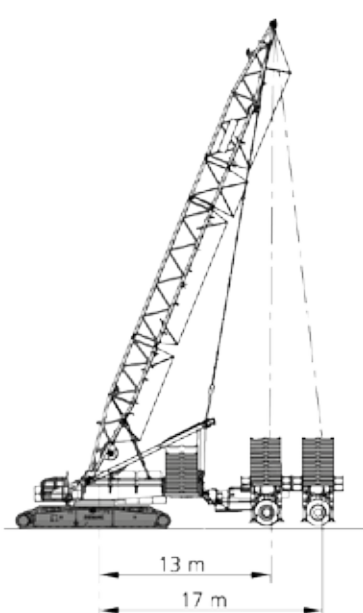

R 17.75 m

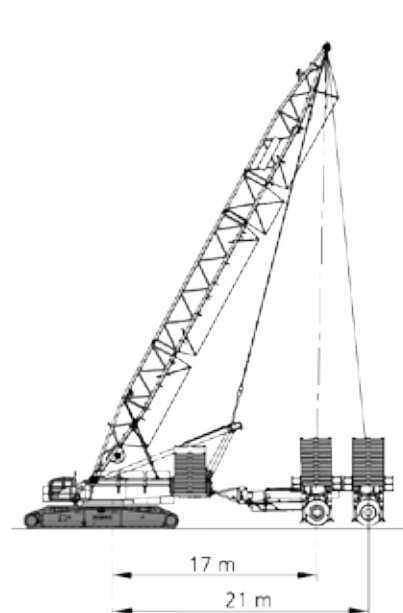

Alternatively, the telescope connector may be used in combination with the Superlift Tray · Alternative Verwendung der Teleskopverbindung mit dem Superlift-Tray ist möglich · Vous pouvez également utiliser un connecteur télescopique avec le plateau SuperLift Tray · In alternativa, può essere utilizzato il cilindro di sfilo in combinazione con il supporto Superlift · Alternativamente se puede utilizar el conector telescópico en combinación con la bandeja Superlift · Como alternativa, o conector do telescópio pode ser usado em combinação com a Base do Superlift · В качестве альтернативы может использоваться телескопический соединитель в сочетании с платформой для противовесов Superlift

Specifications

Technische Daten · Caractéristiques · Dati tecnici ·
 Datos técnicos · Especificações · Технические характеристики

Weights · Gewichte · Poids · Peso · Peso · Peso · Bec

Total weight incl. 165 t counterweight, 24 m boom and hook block approx. 390 t
 Gesamtgewicht einschl. 165 t Gegengewicht, 24 m Hauptausleger und Unterflasche
 Poids avec 165 t de contrepoids, flèche de 24 m et crochet
 Peso totale incl. contrappeso 165 t, braccio 24 m e bozzello
 Peso total incl. contrapeso de 165 t, pluma de 24 m y bloque de gancho
 Peso total incl. Contrapeso de 165 t, lança de 24 m e moitão
 Общий вес, включая противовес 165 т, стрелу длиной 24 м и крюкоблок

Max. Counterweight 205 t
 Max. Gegengewicht · Contrepoids max. · Max. contrappeso ·
 Contrapeso máx. · Máx. contrapeso · Макс. вес противовеса

Max. central ballast 50 t
 Max. Zentralballast · Lest central max. · Max. zavorra centrale ·
 Lastre central máx. · Máx. lastro central · Макс. вес центрального балласта

Specifications

CC 3800-1

Technische Daten · Caractéristiques · Dati tecnici ·
Datos técnicos · Especificações · Технические характеристики

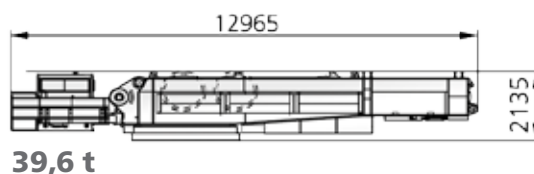
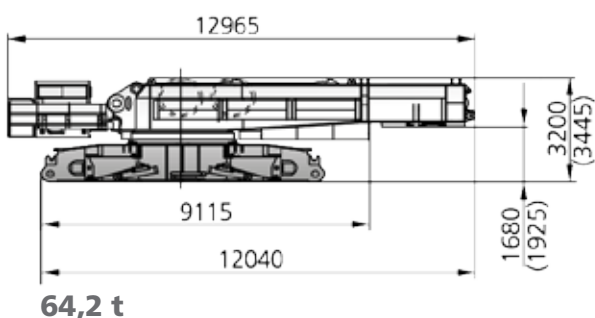
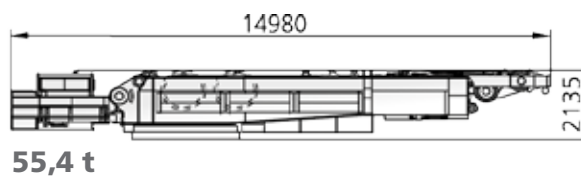
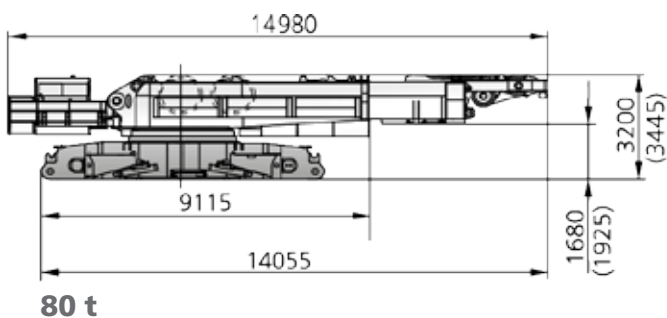

Without winches H1 + H2 (7.0 t each) · Ohne Winden H1 und H2 (je 7,0 t) · Sans treuils H1 + H2 (7,0 t chacun) · Senza argani H1 + H2 (7,0 t ciascuno) · Sin cabestrantes H1 + H2 (7,0 t cada uno) · Sem guinchos H1 + H2 (7,0 t cada) · Без лебедок H1 + H2 (7,0 т каждая)

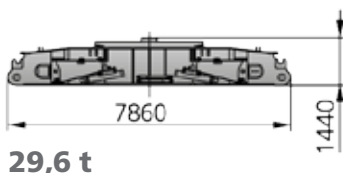
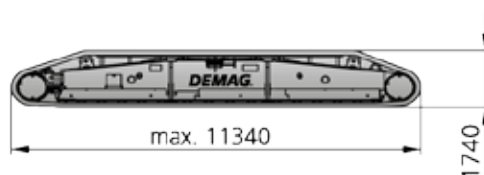
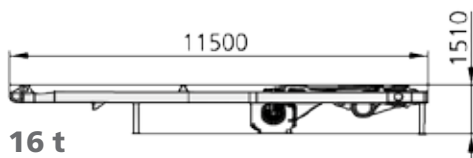

| | Duo | Quadro |
|--------|---------------|---------------|
| 1,50 m | 37,3 t | 40,7 t |
| 2,00 m | 39,0 t | 42,4 t |

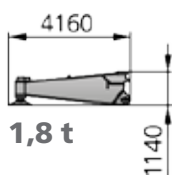

2 additional side jacks optional · 2 x optionale seitliche Zusatzabstützung · 2 appuis latéraux additionnels en option · 2 martinetti laterali aggiuntivi su richiesta · Opcionalmente 2 gatos laterales adicionales · 2 outros macacos laterais opcionais · В качестве опции 2 дополнительные боковые опоры

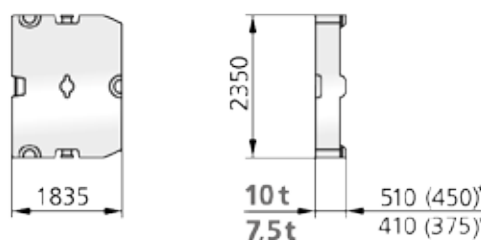

* Optional cast iron · Stahlguss optional · Fonte en option · In ghisa, opzionale · Opcionalmente: hierro fundido · Opcionalmente ferro fundido · По выбору клиента из чугуна

Boom Booster

Typ 3330A

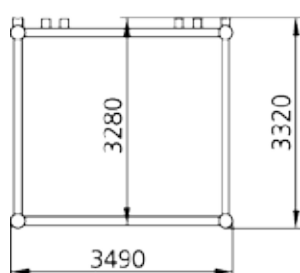

Main Boom (HA)

Typ 2824A

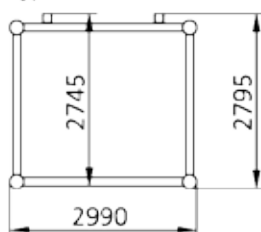

Jib (HI)

Typ 2420A

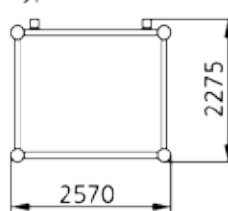

LF

Typ 2016A

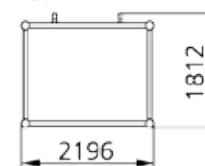

DEMAG
TADANO GROUP

Erection / Lowering

CC 3800-1

Aufrichten / Ablegen · Montée / Placement · Montaggio / Calata ·
Erección / Descenso · Levantamento / Descida · Подъем / опускание

Erection / lowering of the CC 3800-1 boom systems to the ground · Aufrichten / Ablegen der CC 3800-1 Auslegersysteme · Montée / placement sur sol des systèmes de flèche de la CC 3800-1 · Montaggio / calata dei sistemi braccio CC 3800-1 a terra · Erección / descenso al terreno del sistema de pluma del CC 3800-1 · Levantamento / descida dos sistemas da lança do CC 3800-1 para o solo · Подъем / опускание системы стрелы крана CC 3800-1 на землю

| Boom combination Auslegervariante Combinaison de flèche Combinazione braccio Combinación de pluma Combinação de lanças Комбинация стрелы | Fly jib (m) Hilfsausleger Fléchette Falcone Plumín Lança auxiliar Стрела с изменяемым вылетом | Main boom · Hauptausleger · Flèche principale · Braccio base · Pluma principal · Lança principal · Главная стрела | | | | | | | | | | | | | | | | |
|--|---|--|----|----|-------|-----|-----|-----|-----|-----|-----|-----|-----|-----|-----|-----|-----|-----|
| | | m | 24 | 30 | 36 | 42 | 48 | 54 | 60 | 66 | 72 | 78 | 84 | 90 | 96 | 102 | 108 | 114 |
| SH_1 | | | X | X | X | X | X | X | X | X | X | [X] | [X] | [X] | [X] | - | - | - |
| LH_1 | | | - | - | X | X | X | X | X | X | X | X | X | [X] | [X] | [X] | [X] | [X] |
| | | m | 36 | 39 | 42-75 | 78 | 81 | 84 | 87 | 90 | 93 | 96 | 99 | 102 | 105 | 108 | 111 | 114 |
| LH_5 | | | X | X | X | [X] | [X] | [X] | [X] | [X] | [X] | [X] | [X] | [X] | [X] | [X] | [X] | [X] |
| | | m | 24 | 30 | 36 | 42 | 48 | 54 | 60 | 66 | 72 | 78 | 84 | 90 | 96 | 102 | 108 | 114 |
| SW_1 85° | 24 - 36 | | - | X | X | X | X | [X] | [X] | [X] | - | - | - | - | - | - | - | - |
| | 42 - 48 | | - | X | X | X | X | X | [X] | [X] | [X] | - | - | - | - | - | - | - |
| | 54 - 66 | | - | X | X | X | X | [X] | [X] | [X] | [X] | - | - | - | - | - | - | - |
| | 72 - 90 | | - | X | X | X | X | [X] | [X] | [X] | - | - | - | - | - | - | - | - |
| | 96 | | - | X | X | X | [X] | [X] | [X] | [X] | - | - | - | - | - | - | - | - |
| SH+LF_1 15°, 20°, 30° | 12 | | - | X | X | X | X | X | X | X | [X] | [X] | [X] | [X] | - | - | - | - |
| | 24 | | - | X | X | X | X | X | X | [X] | [X] | [X] | [X] | - | - | - | - | - |
| | 36 | | - | X | X | X | X | X | X | [X] | [X] | [X] | - | - | - | - | - | - |
| LH+LF_1 15°, 20°, 30° | 12 | | - | - | - | - | X | X | X | X | X | X | [X] | [X] | [X] | [X] | [X] | [X] |
| | 24 | | - | - | - | - | X | X | X | X | X | X | [X] | [X] | [X] | [X] | [X] | - |
| | 36 | | - | - | - | - | X | X | X | X | X | [X] | [X] | [X] | [X] | [X] | - | - |
| | | m | | | 72 | 75 | 78 | 81 | 84 | 87 | 90 | 93 | 96 | 99 | 102 | 105 | 108 | 111 |
| LH+LF_3 15°, 20° | 12 | | | | X | X | X | X | X | [X] | [X] | [X] | [X] | [X] | [X] | [X] | [X] | [X] |
| LH+LF_4 15°, 20° | 12 | | | | - | - | - | - | [X] | [X] | [X] | [X] | [X] | [X] | [X] | [X] | [X] | - |
| | 18 | | | | - | - | - | - | [X] | [X] | [X] | [X] | [X] | [X] | [X] | - | - | - |

X without assisting equipment · ohne Zusatzausrüstung · sans équipement aditionnel · senza attrezzatura di supporto · sin equipamiento de asistencia · sem equipamento auxiliar · без вспомогательного оборудования

[X] with additional side jack · mit seitlicher Zusatzabstützung · avec support latéral aditionnel · con martinetto laterale aggiuntivo · con gato lateral adicional · com macaco lateral adicional · с дополнительным боковым домкратом

All Superlift combinations can be erected or lowered to the ground without assisting equipment.

Alle Varianten mit Superlift können ohne Zusatzausrüstung aufgerichtet bzw. abgelegt werden.

Montée et dépose sur sol de toutes les combinaisons avec SL sans équipement aditionnel.

Tutte le combinazioni Superlift possono essere alzate o abbassate a terra senza attrezzatura di supporto.

Todas las combinaciones Superlift se pueden erigir o descender al terreno sin equipamiento de asistencia.

Todas as combinações de Superlift podem ser levantadas ou baixadas ao solo sem equipamentos auxiliares.

Оборудование суперлифт в любой конфигурации поднимается и опускается на землю без вспомогательного оборудования.

page 13 · Seite 13 · page 13 · pagina 13 · página 13 · страница 13:

The amount of Superlift counterweight required for erecting the boom system depends on the configuration and the Superlift radius.

Die Menge des zum Aufrichten erforderlichen Superliftgegengewichts ist abhängig von Konfiguration und Superliftradius.

La valeur du contrepoids Superlift nécessaire au montage du système de flèche dépend de la configuration et du rayon Superlift.

La quantità di contrappeso Superlift richiesta per l'allestimento del braccio dipende dalla configurazione e dallo sbraccio del sistema Superlift.

La cantidad de contrapeso Superlift requerido para erigir el sistema de pluma depende de la configuración y el radio Superlift.

A quantidade de contrapesos do Superlift necessária para levantar o sistema da lança depende da configuração e do raio do Superlift.

Количество и вес противовесов Superlift, необходимых для установки системы стрелы, зависит от выбранной конфигурации и радиуса Superlift.

Boom Combinations

CC 3800-1

Ausleger-Kombinationen · Combinaisons de flèche · Combinazioni braccio ·
 Combinaciones de pluma · Combinações de lanças · Комбинации стрелы

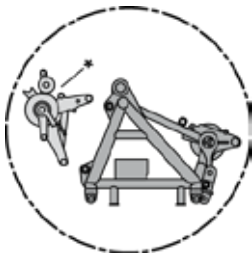

- Typ 2824A
- Typ 2420A

* Attachable · Anbaubar · Amovible · Montabile · Acoplable ·
 Adaptável · Приставн

Runner · Runner (Montagespitze)
 Potence · Runner · Runner
 Ponta de montagem · Подвижной блок

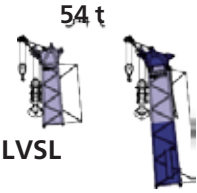

LH, LSL, SW, SWSL, LVSL

SH, SSL

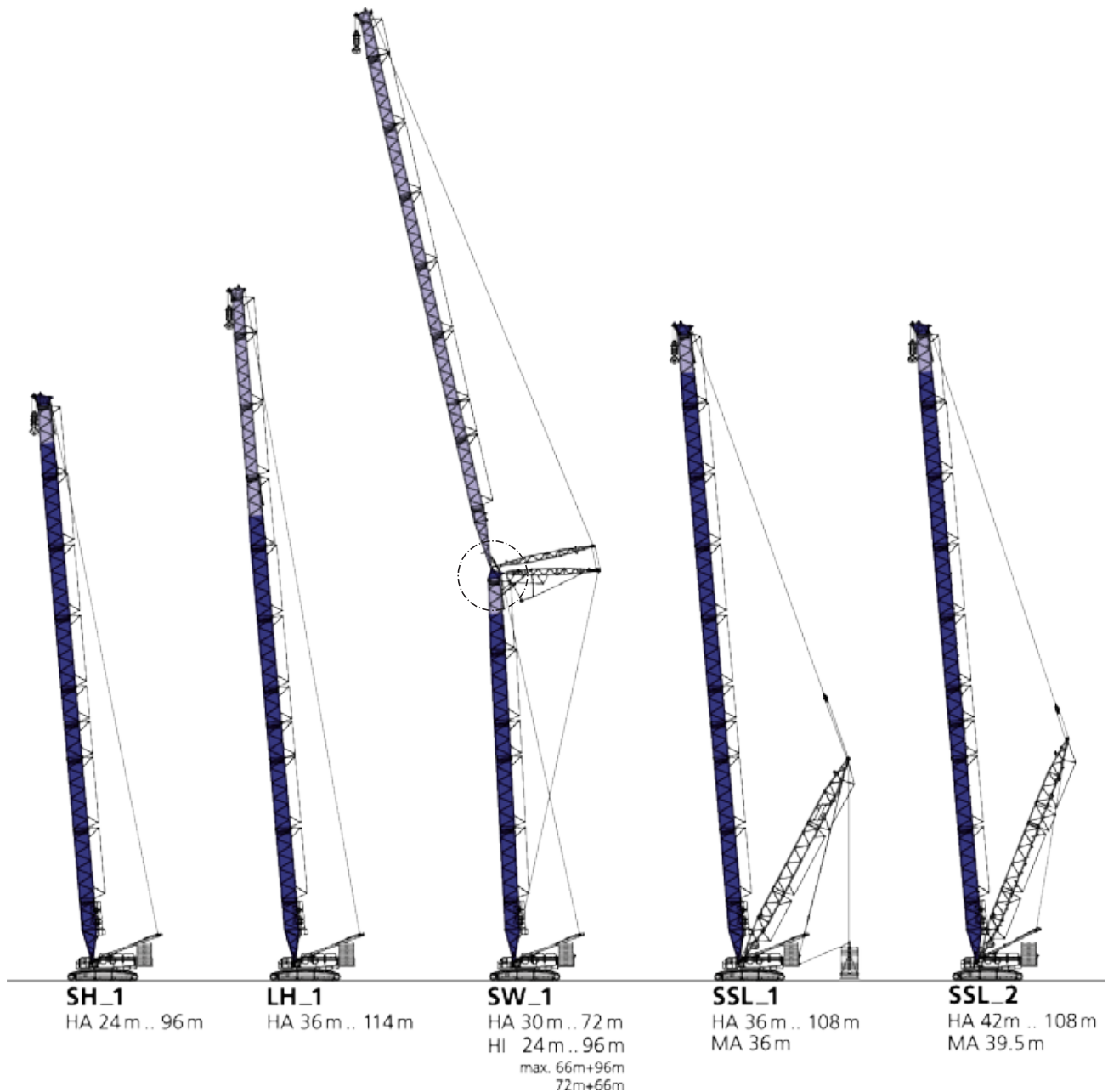

Boom Combinations

CC 3800-1

Ausleger-Kombinationen · Combinaisons de flèche · Combinazioni braccio ·
Combinaciones de pluma · Combinações de lanças · Комбинации стрелы

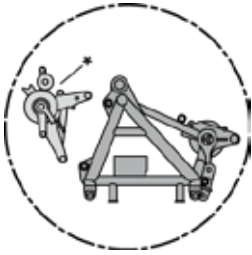

- Typ 2824A
- Typ 2420A

Runner · Runner (Montagespitze)
Potence · Runner · Runner
Ponta de montagem · Подвижной блок

54 t



LH, LSL, SW, SWSL, LVSL

* Attachable · Anbaubar · Amovible · Montabile · Acoplable ·
Adaptável · Приставн

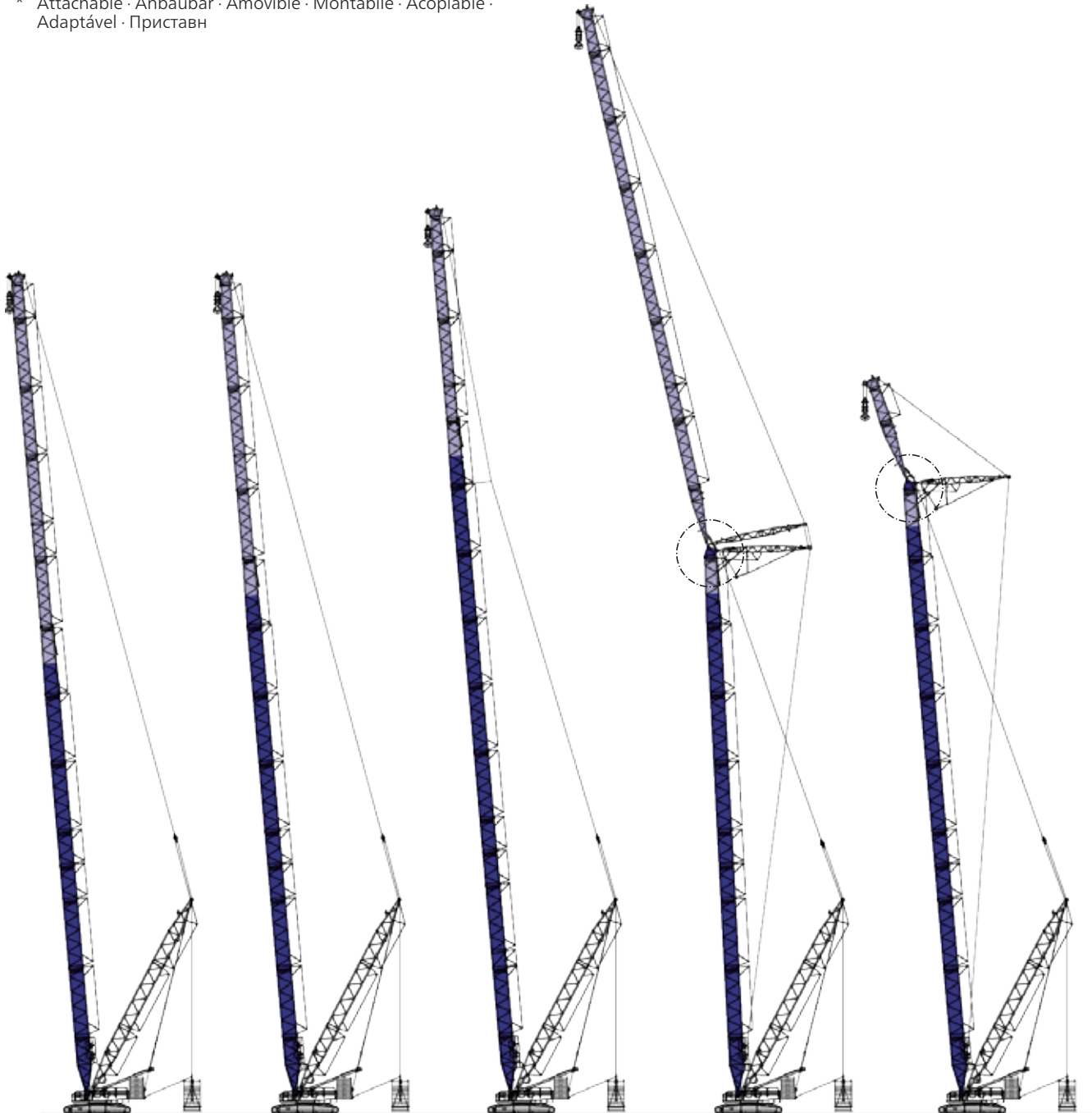

LSL_1
HA 72m .. 144m
MA 36m

LSL_2
HA 54m .. 144m
MA 36m

LSL_5
HA 114m .. 159m
MA 36m

SWSL_1
HA 36m .. 108m
HI 24m .. 96m
max. 96m+96m
102m+90m
108m+60m
MA 36m

LVSL_1
HA 36m .. 108m
HI 18m
MA 36m

Boom Combinations

CC 3800-1

Ausleger-Kombinationen · Combinaisons de flèche · Combinazioni braccio ·
Combinaciones de pluma · Combinações de lanças · Комбинации стрелы

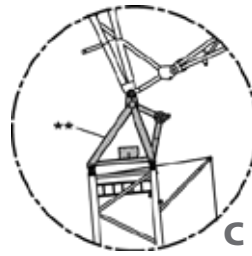
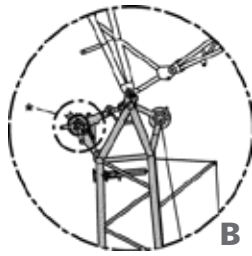
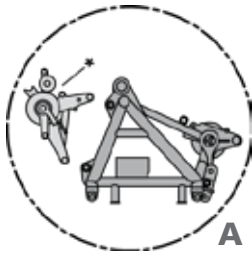

■ Тип 2824A

■ Тип 2420A



* Attachable · Anbaubar · Amovible · Montabile · Acoplable ·
Adaptável · Приставн
** Option · Option · En option · Opzione · Opcion ·
Opcional · Опция

Runner 18 t on LF standard
Runner (Montagespitze) Standard an LF
Potence 18 t de série sur LF · Runner da 18 t su LF
di serie · Runner 18 t en LF estándar
Ponta de montagem de 18 t padrão em LF
Подвижной блок 18 т на стреле LF,
стандартная комплектация



SH+LF_1

HA 30m .. 96m
HI 12m .. 36m
max. 84m + 36m
90m + 24m
96m + 12m

LH+LF_1

HA 48m .. 114m
HI 12m .. 36m
max. 102m + 36m
108m + 24m
114m + 12m

LH+LF_3

HA 72m .. 111m
HI 12m

Boom Combinations

CC 3800-1

Ausleger-Kombinationen · Combinaisons de flèche · Combinazioni braccio ·
Combinaciones de pluma · Combinações de lanças · Комбинации стрелы

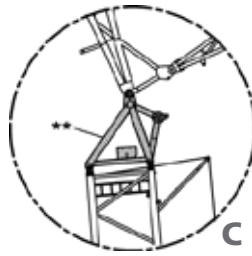
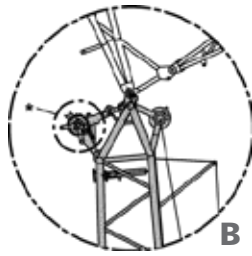
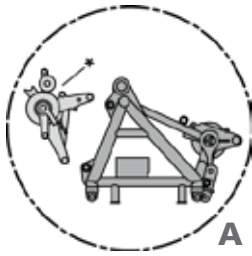

Typ 2824A

Typ 2420A



* Attachable · Anbaubar · Amovible · Montabile · Acoplable ·
Adaptável · Приставн

** Option · Option · En option · Opzione · Opcion ·
Opcional · Опция

Runner 18 t on LF standard
siehe Seite 16
voir page 16
vedi pagina 16
ver página 16
см. на стр. 16

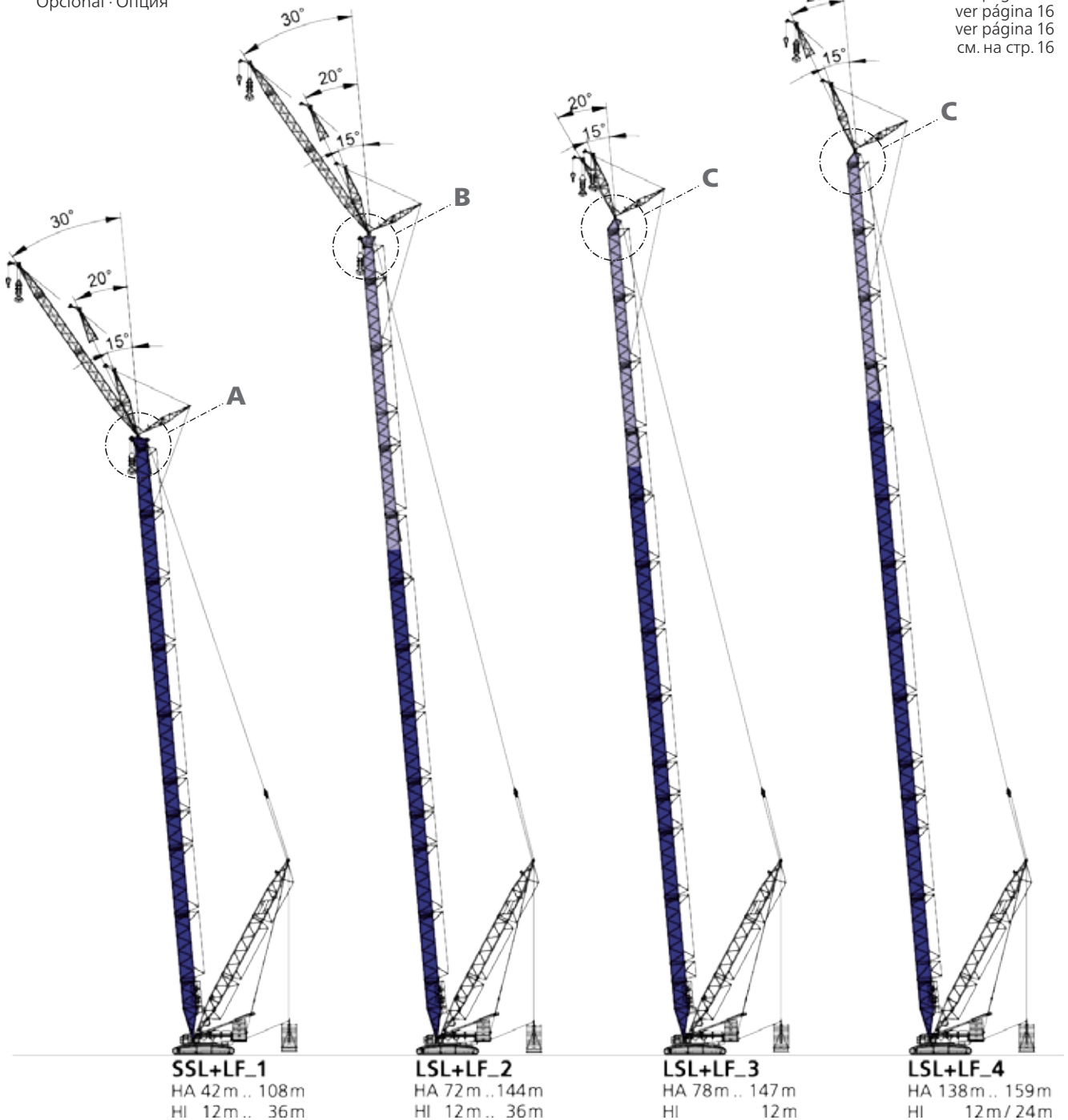

Boom Combinations Boom Booster

CC 3800-1

Ausleger-Kombinationen · Combinaisons de flèche · Combinazioni braccio ·
Combinaciones de pluma · Combinações de lanças · Комбинации стрелы

Boom system type 3330A in combination with extended SL mast (39.5 m or 42 m); 2824A and 2420A with slide-in function.

Boom-System Typ 3330A in Kombination mit verlängertem SL-Mast (39,5 m bzw. 42 m) 2824A und 2420A einschiebbar.

Système de flèche 3330A avec mât SL étendu (39,5 m ou 42 m) ; système de flèche 2824A et 2420A avec dispositif coulissant.

Braccio tipo 3330A in combinazione con il montante SL esteso (39,5 m o 42 m); 2824A e 2420A completi di funzione di scorrimento.

Sistema de pluma tipo 3330A en combinación con mástil SL extendido (39,5 m o 42 m); 2824A y 2420A con función insertable.

Sistema de lança tipo 3330A em conjunto com torre do SL estendida (39,5 m ou 42 m); 2824A e 2420A com função de encaixe.

Тип системы стрелы 3330A в сочетании с мачтой SL с удлинителем (39,5 или 42 м); 2824A и 2420A с функцией выдвижения.

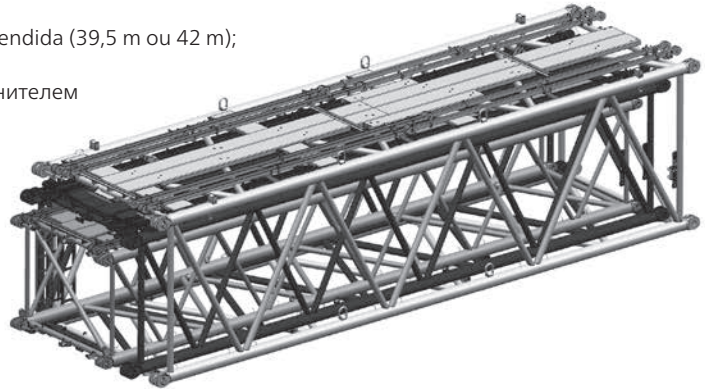

- Typ 3330A
- Typ 2824A
- Typ 2420A

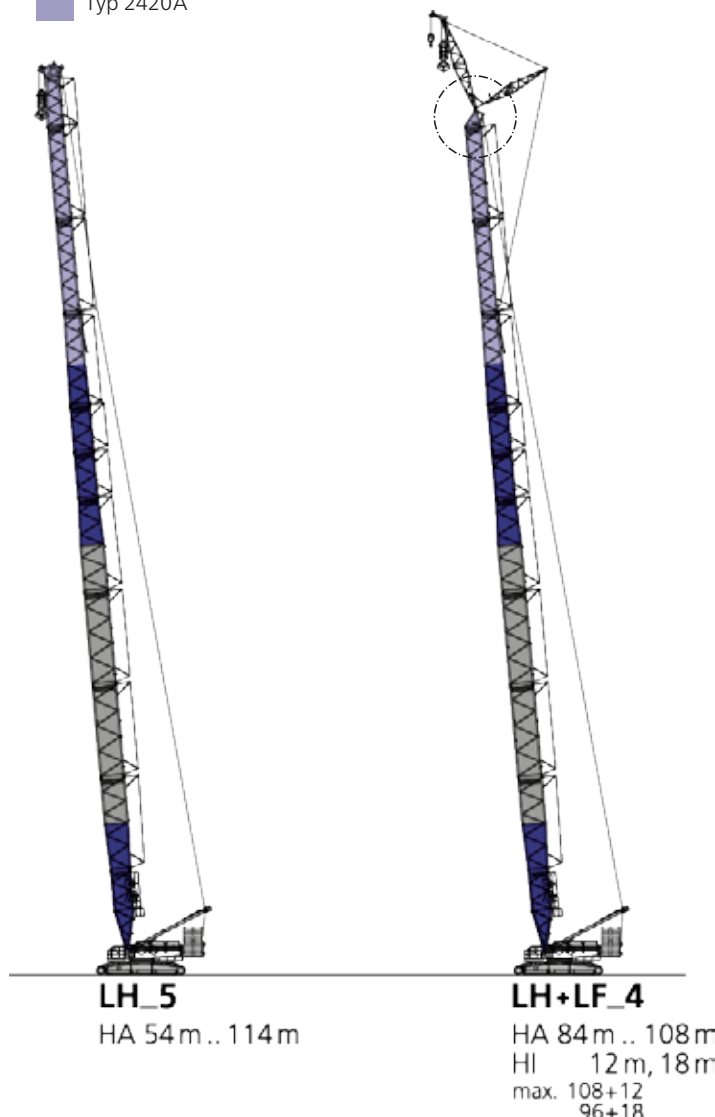

Runner · Runner (Montagespitze)
Potence · Runner · Runner
Ponta de montagem · Подвижной блок

54 t



LH, LSL, SW, SWSL, LVSL

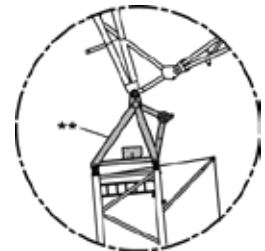

** Option · Option · En option · Opzione
Opcion · Opcional · Опция



Runner 18 t on LF standard
Runner (Montagespitze) Standard an LF
Potence 18 t de série sur LF · Runner da 18 t su LF
di serie · Runner 18 t en LF estándar
Ponta de montagem de 18 t padrão em LF
Подвижной блок 18 т на стреле LF,
стандартная комплектация

Boom Combinations Boom Booster

CC 3800-1

Ausleger-Kombinationen · Combinaisons de flèche · Combinazioni braccio ·
Combinaciones de pluma · Combinações de lanças · Комбинации стрелы

■ Тип 3330A

■ Тип 2824A

■ Тип 2420A

Runner · Runner (Montagespitze)
Potence · Runner · Runner
Ponta de montagem · Подвижной блок

54 t



SH, SSL

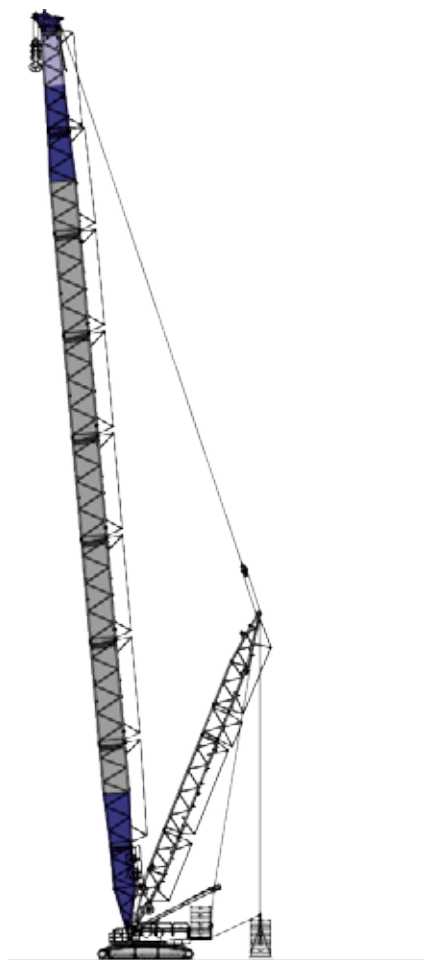

SSL_3 / SSL_4

HA 48m / 60m ...108m

Boom Combinations Boom Booster

CC 3800-1

Ausleger-Kombinationen · Combinaisons de flèche · Combinazioni braccio ·
Combinaciones de pluma · Combinações de lanças · Комбинации стрелы

- Typ 3330A
- Typ 2824A
- Typ 2420A

Runner · Runner (Montagespitze)
Potence · Runner · Runner
Ponta de montagem · Подвижной блок

54 t



LSL

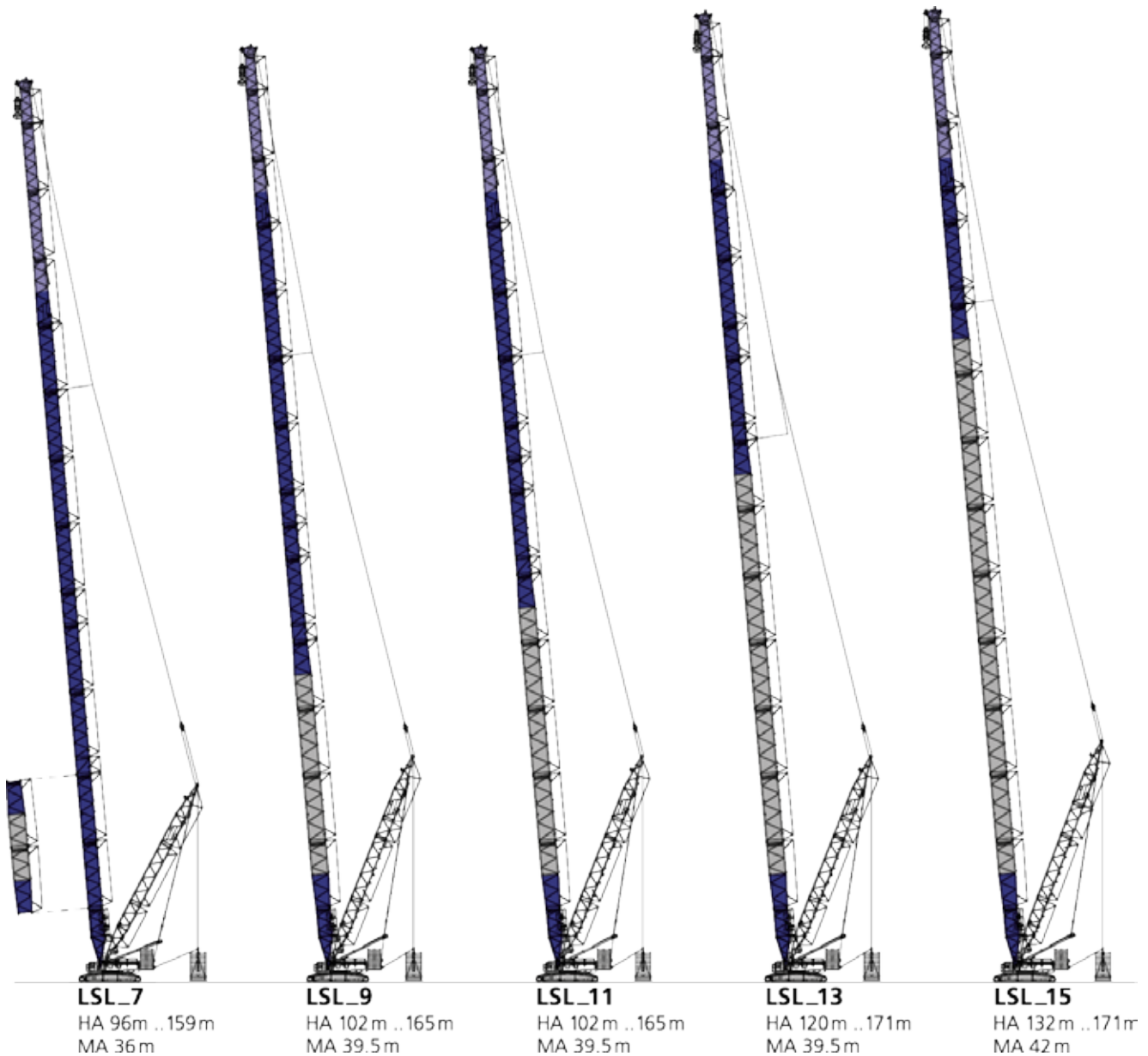

Boom Combinations Boom Booster

CC 3800-1

Ausleger-Kombinationen · Combinaisons de flèche · Combinazioni braccio ·
Combinaciones de pluma · Combinações de lanças · Комбинации стрелы

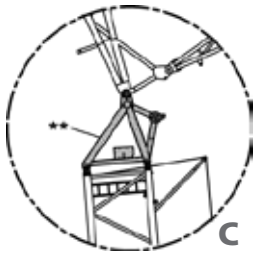

- Тип 3330A
- Тип 2824A
- Тип 2420A



** Option · Option · En option · Opzione · Opcion ·
Opcional · Опция

Runner 18 t on LF standard
Runner (Montagespitze) Standard an LF
Potence 18 t de série sur LF · Runner da 18 t su LF
di serie · Runner 18 t en LF estándar
Ponta de montagem de 18 t padrão em LF
Подвижной блок 18 т на стреле LF,
стандартная комплектация

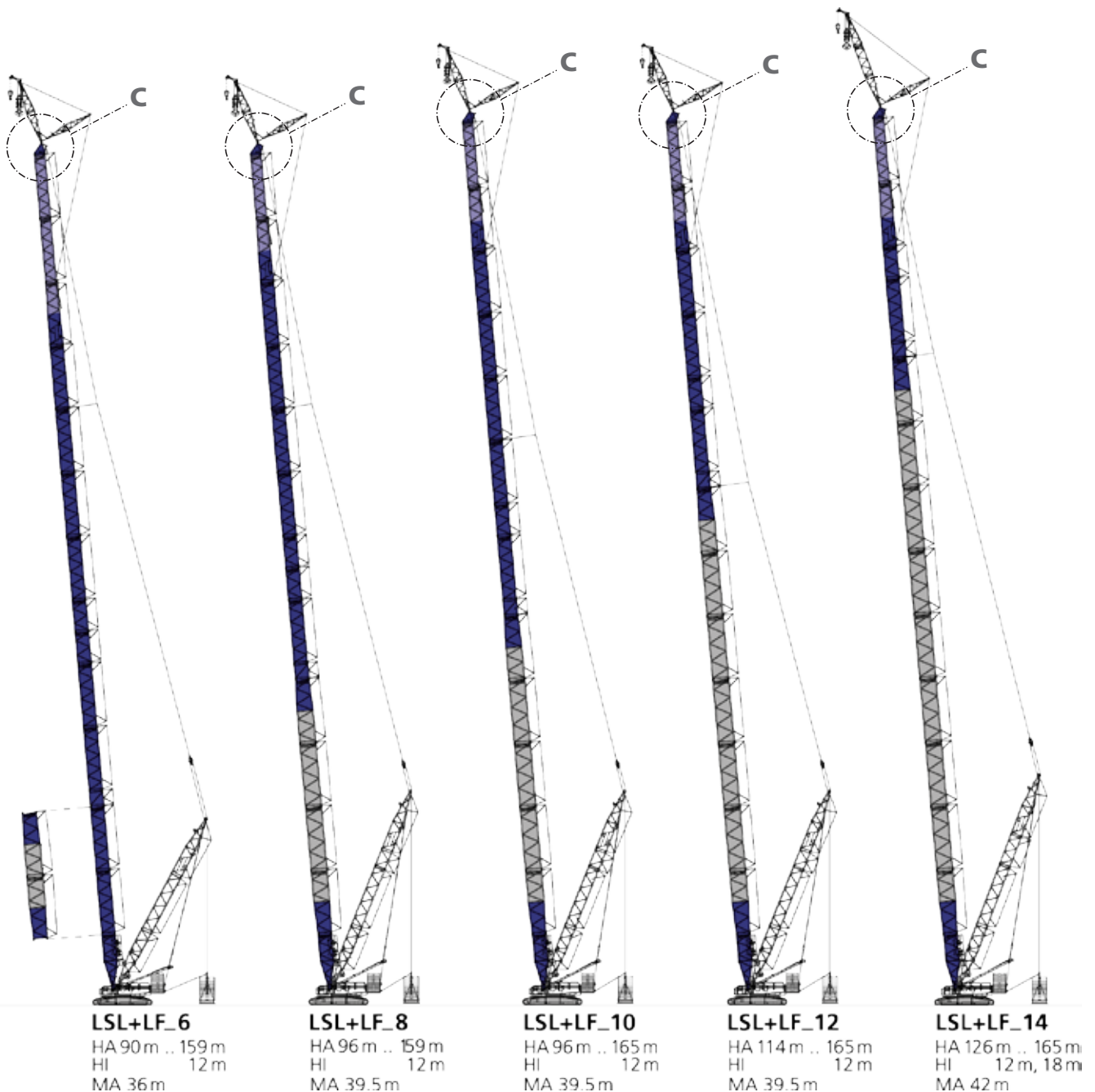

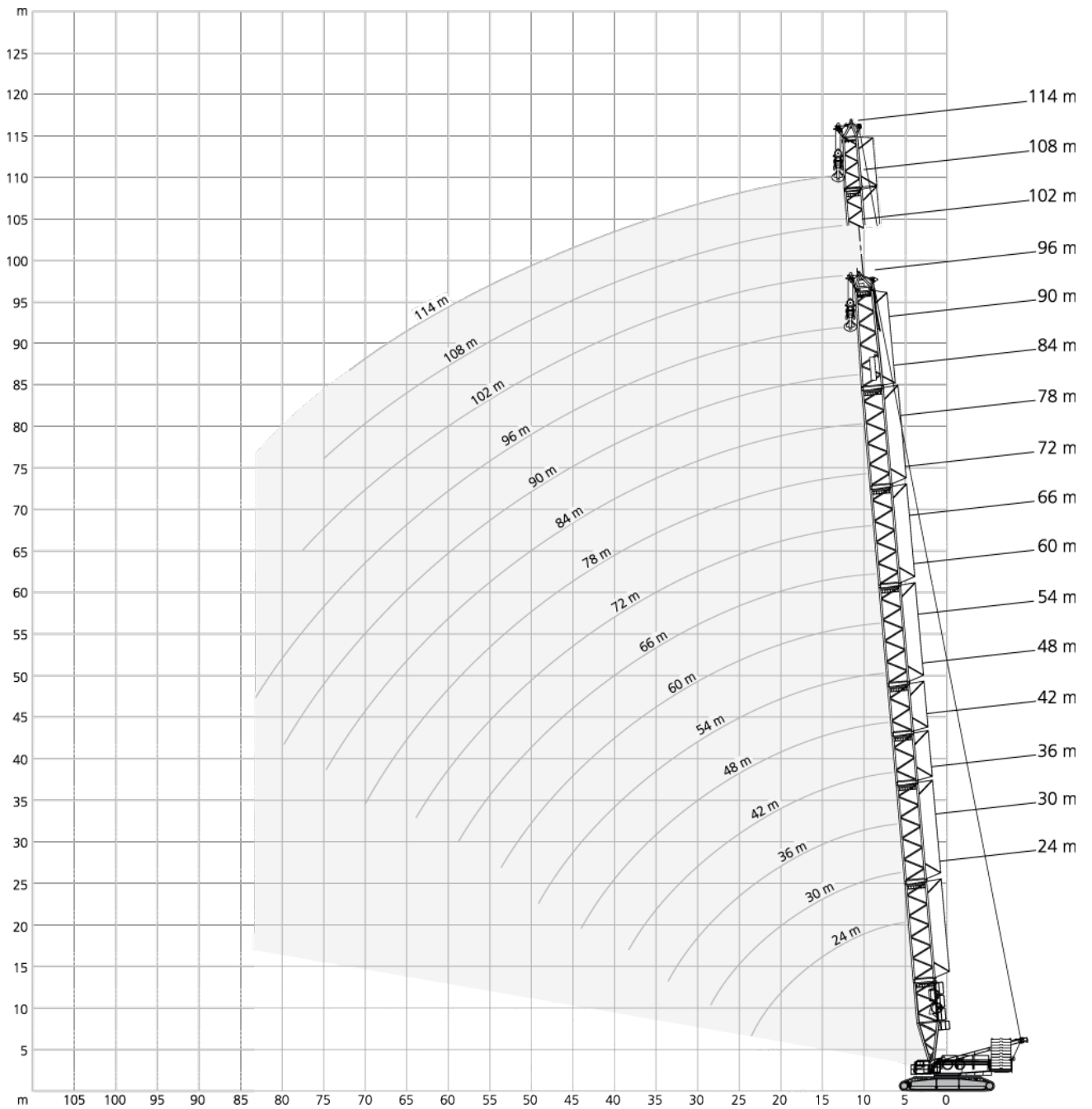

| | | + | | 8,40 m | | 9.8 m/s | | 360° | | ISO | | | | | | | | | | | | | | | | | | | | |
|------|-------|-------|-------|--------|-------|---------|-------|-------|-------|-------|-------|-------|-------|------|---|------|---|------|---|------|---|------|---|------|---|------|---|---|-----|---|
| SH_1 | | | | | | | | | | | | | | | | | | | | | | | | | | | | | | |
| | | 24 m | | 30 m | | 36 m | | 42 m | | 48 m | | 54 m | | 60 m | | 66 m | | 72 m | | 78 m | | 84 m | | 90 m | | 96 m | | | | |
| m | t | t | t | t | t | t | t | t | t | t | t | t | t | t | t | t | t | t | t | t | t | t | t | t | t | t | t | t | t | m |
| 5,5 | 634,0 | - | - | - | - | - | - | - | - | - | - | - | - | - | - | - | - | - | - | - | - | - | - | - | - | - | - | - | 5,5 | |
| 6 | 598,0 | 595,0 | - | - | - | - | - | - | - | - | - | - | - | - | - | - | - | - | - | - | - | - | - | - | - | - | - | - | 6 | |
| 7 | 537,0 | 534,0 | 531,0 | 490,0 | - | - | - | - | - | - | - | - | - | - | - | - | - | - | - | - | - | - | - | - | - | - | - | - | 7 | |
| 8 | 479,0 | 477,0 | 451,0 | 419,0 | 391,0 | 366,0 | - | - | - | - | - | - | - | - | - | - | - | - | - | - | - | - | - | - | - | - | - | - | 8 | |
| 9 | 423,0 | 418,0 | 390,0 | 365,0 | 343,0 | 323,0 | 304,0 | - | - | - | - | - | - | - | - | - | - | - | - | - | - | - | - | - | - | - | - | - | 9 | |
| 10 | 379,0 | 365,0 | 343,0 | 323,0 | 305,0 | 288,0 | 273,0 | 259,0 | 246,0 | - | - | - | - | - | - | - | - | - | - | - | - | - | - | - | - | - | - | - | 10 | |
| 11 | 334,0 | 326,5 | 309,5 | 292,5 | 277,0 | 262,5 | 249,0 | 237,0 | 225,5 | 214,0 | 204,0 | - | - | - | - | - | - | - | - | - | - | - | - | - | - | - | - | - | 11 | |
| 12 | 289,0 | 288,0 | 276,0 | 262,0 | 249,0 | 237,0 | 225,0 | 215,0 | 205,0 | 197,0 | 188,0 | 181,0 | 173,0 | - | - | - | - | - | - | - | - | - | - | - | - | - | - | - | 12 | |
| 14 | 225,0 | 225,0 | 224,0 | 219,0 | 209,0 | 200,0 | 191,0 | 183,0 | 175,0 | 168,0 | 161,0 | 155,0 | 149,0 | - | - | - | - | - | - | - | - | - | - | - | - | - | - | - | 14 | |
| 16 | 184,0 | 183,0 | 182,0 | 181,0 | 179,0 | 172,0 | 164,0 | 158,0 | 151,0 | 146,0 | 140,0 | 135,0 | 130,0 | - | - | - | - | - | - | - | - | - | - | - | - | - | - | - | 16 | |
| 18 | 154,0 | 153,0 | 152,0 | 151,0 | 150,0 | 149,0 | 144,0 | 139,0 | 133,0 | 128,0 | 123,0 | 119,0 | 114,0 | - | - | - | - | - | - | - | - | - | - | - | - | - | - | - | 18 | |
| 20 | 133,0 | 132,0 | 130,0 | 129,0 | 128,0 | 127,0 | 126,0 | 123,0 | 117,0 | 114,0 | 109,0 | 106,0 | 101,0 | - | - | - | - | - | - | - | - | - | - | - | - | - | - | - | 20 | |
| 22 | 116,0 | 115,0 | 114,0 | 112,0 | 111,0 | 110,0 | 109,0 | 109,0 | 105,0 | 102,0 | 97,5 | 95,0 | 90,5 | - | - | - | - | - | - | - | - | - | - | - | - | - | - | - | 22 | |
| 23 | 109,0 | 108,0 | 107,0 | 105,5 | 104,5 | 103,5 | 102,2 | 102,2 | 99,5 | 96,7 | 92,5 | 90,2 | 86,0 | - | - | - | - | - | - | - | - | - | - | - | - | - | - | - | 23 | |
| 24 | - | 101,0 | 100,0 | 99,0 | 98,0 | 97,0 | 95,5 | 95,5 | 94,0 | 91,5 | 87,5 | 85,5 | 81,5 | - | - | - | - | - | - | - | - | - | - | - | - | - | - | - | 24 | |
| 26 | - | 91,0 | 89,5 | 88,0 | 87,0 | 85,5 | 84,5 | 84,0 | 83,0 | 82,5 | 79,0 | 77,0 | 73,5 | - | - | - | - | - | - | - | - | - | - | - | - | - | - | - | 26 | |
| 28 | - | 82,0 | 80,5 | 79,0 | 77,5 | 76,5 | 75,5 | 75,0 | 73,5 | 73,0 | 71,5 | 70,0 | 66,5 | - | - | - | - | - | - | - | - | - | - | - | - | - | - | - | 28 | |
| 30 | - | - | 73,0 | 71,0 | 70,0 | 68,5 | 67,5 | 67,0 | 66,0 | 65,0 | 64,0 | 63,5 | 60,5 | - | - | - | - | - | - | - | - | - | - | - | - | - | - | - | 30 | |
| 33 | - | - | 63,5 | 62,0 | 60,6 | 59,5 | 58,1 | 57,6 | 56,0 | 55,5 | 54,5 | 54,5 | 52,6 | - | - | - | - | - | - | - | - | - | - | - | - | - | - | - | 33 | |
| 34 | - | - | - | 59,0 | 57,5 | 56,5 | 55,0 | 54,5 | 53,5 | 52,5 | 51,5 | 51,5 | 50,0 | - | - | - | - | - | - | - | - | - | - | - | - | - | - | - | 34 | |
| 38 | - | - | - | 50,0 | 48,7 | 47,3 | 46,0 | 45,4 | 44,0 | 43,3 | 41,8 | 41,5 | 40,2 | - | - | - | - | - | - | - | - | - | - | - | - | - | - | - | 38 | |
| 42 | - | - | - | - | 41,6 | 40,1 | 38,5 | 37,7 | 36,1 | 35,3 | 33,8 | 33,5 | 32,1 | - | - | - | - | - | - | - | - | - | - | - | - | - | - | - | 42 | |
| 44 | - | - | - | - | 38,6 | 37,1 | 35,3 | 34,4 | 32,9 | 32,1 | 30,6 | 30,3 | 28,9 | - | - | - | - | - | - | - | - | - | - | - | - | - | - | - | 44 | |
| 46 | - | - | - | - | - | 34,1 | 32,3 | 31,5 | 29,7 | 29,0 | 27,4 | 27,1 | 25,7 | - | - | - | - | - | - | - | - | - | - | - | - | - | - | - | 46 | |
| 49 | - | - | - | - | - | 30,4 | 28,5 | 27,6 | 25,8 | 25,1 | 23,4 | 23,0 | 21,7 | - | - | - | - | - | - | - | - | - | - | - | - | - | - | - | 49 | |
| 50 | - | - | - | - | - | - | 27,3 | 26,3 | 24,5 | 23,8 | 22,2 | 21,8 | 20,4 | - | - | - | - | - | - | - | - | - | - | - | - | - | - | - | 50 | |
| 54 | - | - | - | - | - | - | 23,2 | 22,1 | 20,2 | 19,4 | 17,8 | 17,4 | 15,9 | - | - | - | - | - | - | - | - | - | - | - | - | - | - | - | 54 | |
| 58 | - | - | - | - | - | - | - | 18,6 | 16,6 | 15,8 | 14,1 | 13,7 | 12,2 | - | - | - | - | - | - | - | - | - | - | - | - | - | - | - | 58 | |
| 59 | - | - | - | - | - | - | - | 17,8 | 15,8 | 15,0 | 13,3 | 12,9 | 11,3 | - | - | - | - | - | - | - | - | - | - | - | - | - | - | - | 59 | |
| 62 | - | - | - | - | - | - | - | - | 13,6 | 12,7 | 11,0 | 10,5 | 9,0 | - | - | - | - | - | - | - | - | - | - | - | - | - | - | - | 62 | |
| 64 | - | - | - | - | - | - | - | - | 12,3 | 11,4 | 9,6 | 9,1 | 7,6 | - | - | - | - | - | - | - | - | - | - | - | - | - | - | - | 64 | |
| 66 | - | - | - | - | - | - | - | - | - | 10,1 | 8,3 | 7,8 | 6,2 | - | - | - | - | - | - | - | - | - | - | - | - | - | - | - | 66 | |
| 67 | - | - | - | - | - | - | - | - | - | - | 9,5 | 7,7 | 5,6 | - | - | - | - | - | - | - | - | - | - | - | - | - | - | - | 67 | |
| 70 | - | - | - | - | - | - | - | - | - | - | 7,9 | 5,9 | - | - | - | - | - | - | - | - | - | - | - | - | - | - | - | - | 70 | |
| 71 | - | - | - | - | - | - | - | - | - | - | - | 5,4 | - | - | - | - | - | - | - | - | - | - | - | - | - | - | - | - | 71 | |

185 t 205 t
 30 t 50 t

| | | 8,40 m | | 9.8 m/s | | 360° | | ISO | | | | | | |
|------|-------|--------|-------|---------|-------|-------|-------|-------|-------|-------|-------|-------|-------|-----|
| SH_1 | | | | | | | | | | | | | | |
| | 24 m | 30 m | 36 m | 42 m | 48 m | 54 m | 60 m | 66 m | 72 m | 78 m | 84 m | 90 m | 96 m | |
| m | t | t | t | t | t | t | t | t | t | t | t | t | t | m |
| 5,5 | 625,0 | - | - | - | - | - | - | - | - | - | - | - | - | 5,5 |
| 6 | 574,0 | 577,0 | - | - | - | - | - | - | - | - | - | - | - | 6 |
| 7 | 512,0 | 463,0 | 423,0 | 388,0 | - | - | - | - | - | - | - | - | - | 7 |
| 8 | 420,0 | 386,0 | 357,0 | 331,0 | 308,0 | 288,0 | - | - | - | - | - | - | - | 8 |
| 9 | 356,0 | 331,0 | 308,0 | 288,0 | 270,0 | 254,0 | 239,0 | - | - | - | - | - | - | 9 |
| 10 | 308,0 | 288,0 | 270,0 | 254,0 | 239,0 | 226,0 | 213,0 | 202,0 | 192,0 | - | - | - | - | 10 |
| 11 | 267,5 | 257,5 | 243,0 | 229,5 | 216,5 | 205,0 | 194,0 | 184,5 | 175,5 | 166,0 | 158,0 | - | - | 11 |
| 12 | 227,0 | 227,0 | 216,0 | 205,0 | 194,0 | 184,0 | 175,0 | 167,0 | 159,0 | 152,0 | 144,0 | 139,0 | 132,0 | 12 |
| 14 | 177,0 | 176,0 | 175,0 | 170,0 | 162,0 | 155,0 | 147,0 | 141,0 | 134,0 | 129,0 | 123,0 | 118,0 | 112,0 | 14 |
| 16 | 143,0 | 142,0 | 142,0 | 140,0 | 138,0 | 132,0 | 126,0 | 121,0 | 115,0 | 111,0 | 106,0 | 102,0 | 97,5 | 16 |
| 18 | 120,0 | 119,0 | 118,0 | 117,0 | 116,0 | 115,0 | 109,0 | 105,0 | 100,0 | 97,0 | 92,0 | 89,5 | 85,0 | 18 |
| 20 | 103,0 | 101,0 | 100,0 | 99,5 | 98,5 | 97,5 | 96,5 | 92,5 | 88,0 | 85,0 | 81,0 | 78,5 | 74,5 | 20 |
| 22 | 89,5 | 88,5 | 87,0 | 85,5 | 85,0 | 84,0 | 83,0 | 82,0 | 78,0 | 75,5 | 71,5 | 69,5 | 65,5 | 22 |
| 23 | 84,0 | 83,0 | 81,7 | 80,2 | 79,5 | 78,5 | 77,5 | 76,7 | 73,7 | 71,2 | 67,5 | 65,7 | 62,0 | 23 |
| 24 | - | 77,5 | 76,5 | 75,0 | 74,0 | 73,0 | 72,0 | 71,5 | 69,5 | 67,0 | 63,5 | 62,0 | 58,5 | 24 |
| 26 | - | 69,0 | 67,5 | 66,0 | 65,0 | 64,0 | 63,0 | 62,5 | 61,0 | 60,0 | 56,5 | 55,0 | 52,0 | 26 |
| 28 | - | 62,0 | 60,5 | 59,0 | 58,0 | 56,5 | 55,5 | 55,0 | 53,5 | 53,0 | 50,5 | 49,6 | 46,4 | 28 |
| 30 | - | - | 54,5 | 53,0 | 51,5 | 50,5 | 49,4 | 48,9 | 47,6 | 47,1 | 45,7 | 44,5 | 41,5 | 30 |
| 33 | - | - | 47,3 | 45,8 | 44,4 | 43,2 | 41,9 | 41,2 | 39,5 | 38,9 | 37,6 | 37,2 | 35,2 | 33 |
| 34 | - | - | - | 43,4 | 42,1 | 40,8 | 39,4 | 38,7 | 37,2 | 36,5 | 35,0 | 34,8 | 33,1 | 34 |
| 38 | - | - | - | 36,3 | 34,6 | 33,0 | 31,4 | 30,7 | 29,1 | 28,4 | 26,9 | 26,6 | 25,3 | 38 |
| 42 | - | - | - | - | 28,7 | 26,9 | 25,2 | 24,4 | 22,8 | 22,0 | 20,5 | 20,2 | 18,8 | 42 |
| 44 | - | - | - | - | 26,2 | 24,5 | 22,6 | 21,8 | 20,2 | 19,4 | 17,9 | 17,6 | 16,2 | 44 |
| 46 | - | - | - | - | - | 22,1 | 20,3 | 19,4 | 17,7 | 16,9 | 15,4 | 15,1 | 13,7 | 46 |
| 49 | - | - | - | - | - | 19,2 | 17,3 | 16,4 | 14,6 | 13,8 | 12,2 | 11,9 | 10,4 | 49 |
| 50 | - | - | - | - | - | - | 16,3 | 15,4 | 13,6 | 12,8 | 11,2 | 10,9 | 9,4 | 50 |
| 54 | - | - | - | - | - | - | 13,1 | 12,0 | 10,1 | 9,3 | 7,7 | 7,3 | 5,9 | 54 |
| 55 | - | - | - | - | - | - | - | 11,3 | 9,4 | 8,5 | 6,9 | 6,5 | 5,1 | 55 |
| 57 | - | - | - | - | - | - | - | 9,9 | 8,0 | 7,1 | 5,5 | 5,1 | - | 57 |
| 58 | - | - | - | - | - | - | - | 9,3 | 7,3 | 6,4 | - | - | - | 58 |
| 59 | - | - | - | - | - | - | - | 8,7 | 6,7 | 5,8 | - | - | - | 59 |
| 60 | - | - | - | - | - | - | - | - | 6,1 | 5,2 | - | - | - | 60 |
| 61 | - | - | - | - | - | - | - | - | 5,5 | - | - | - | - | 61 |

125 t 165 t

| | | 8,40 m | | | | | | | | | | 9.8 m/s | | | | 360° | | | | ISO | | | | | | | | |
|----|-------|--------|-------|-------|-------|-------|-------|-------|-------|-------|-------|---------|-------|-------|-------|-------|-------|-------|-------|-------|-------|-------|-------|-------|-------|-------|-------|----|
| | | 36m | | 42m | | 48m | | 54m | | 57m | | 60m | | 63m | | 66m | | 69m | | 72m | | 75m | | 78m | | 81m | | |
| | | LH_1 | | | | LH_5 | | | | LH_1 | | | | LH_5 | | | | LH_1 | | | | LH_5 | | | | | | |
| m | t | t | t | t | t | t | t | t | t | t | t | t | t | t | t | t | t | t | t | t | t | t | t | t | t | t | m | |
| 7 | 347,0 | 347,0 | - | - | - | - | - | - | - | - | - | - | - | - | - | - | - | - | - | - | - | - | - | - | - | - | 7 | |
| 8 | 347,0 | 347,0 | 347,0 | 347,0 | 347,0 | 347,0 | 347,0 | 347,0 | 347,0 | 347,0 | 347,0 | 347,0 | 347,0 | 347,0 | 347,0 | 347,0 | 347,0 | 347,0 | 347,0 | 347,0 | 347,0 | 347,0 | 347,0 | 347,0 | 347,0 | 347,0 | 347,0 | 8 |
| 9 | 347,0 | 347,0 | 347,0 | 333,0 | 347,0 | 347,0 | 314,0 | 347,0 | 346,0 | 297,0 | 337,0 | 328,0 | - | - | - | - | - | - | - | - | - | - | - | - | - | - | 9 | |
| 10 | 347,0 | 331,0 | 315,0 | 298,0 | 334,0 | 326,0 | 282,0 | 318,0 | 310,0 | 268,0 | 302,0 | 295,0 | 255,0 | 288,0 | 281,0 | 243,0 | 274,0 | 268,0 | 268,0 | 268,0 | 268,0 | 268,0 | 268,0 | 268,0 | 268,0 | 268,0 | 10 | |
| 12 | 283,0 | 268,0 | 258,0 | 246,0 | 273,0 | 267,0 | 234,0 | 261,0 | 255,0 | 224,0 | 250,0 | 244,0 | 214,0 | 239,0 | 233,0 | 205,0 | 228,0 | 223,0 | 223,0 | 223,0 | 223,0 | 223,0 | 223,0 | 223,0 | 223,0 | 223,0 | 12 | |
| 14 | 231,0 | 225,0 | 218,0 | 208,0 | 229,0 | 225,0 | 200,0 | 220,0 | 216,0 | 191,0 | 211,0 | 207,0 | 184,0 | 203,0 | 198,0 | 176,0 | 194,0 | 190,0 | 190,0 | 190,0 | 190,0 | 190,0 | 190,0 | 190,0 | 190,0 | 190,0 | 14 | |
| 16 | 189,0 | 188,0 | 188,0 | 180,0 | 197,0 | 193,0 | 173,0 | 190,0 | 186,0 | 166,0 | 182,0 | 179,0 | 160,0 | 176,0 | 172,0 | 154,0 | 168,0 | 165,0 | 165,0 | 165,0 | 165,0 | 165,0 | 165,0 | 165,0 | 165,0 | 165,0 | 16 | |
| 18 | 159,0 | 157,0 | 158,0 | 157,0 | 166,0 | 165,0 | 152,0 | 165,0 | 163,0 | 146,0 | 160,0 | 157,0 | 141,0 | 154,0 | 150,0 | 136,0 | 147,0 | 144,0 | 144,0 | 144,0 | 144,0 | 144,0 | 144,0 | 144,0 | 144,0 | 144,0 | 18 | |
| 20 | 136,0 | 135,0 | 136,0 | 135,0 | 142,0 | 141,0 | 134,0 | 141,0 | 140,0 | 130,0 | 139,0 | 138,0 | 126,0 | 136,0 | 133,0 | 121,0 | 131,0 | 128,0 | 128,0 | 128,0 | 128,0 | 128,0 | 128,0 | 128,0 | 128,0 | 128,0 | 20 | |
| 22 | 119,0 | 118,0 | 119,0 | 117,0 | 123,0 | 122,0 | 116,0 | 122,0 | 121,0 | 115,0 | 121,0 | 120,0 | 113,0 | 120,0 | 118,0 | 109,0 | 117,0 | 114,0 | 114,0 | 114,0 | 114,0 | 114,0 | 114,0 | 114,0 | 114,0 | 114,0 | 22 | |
| 24 | 106,0 | 104,0 | 105,0 | 103,0 | 109,0 | 108,0 | 103,0 | 108,0 | 107,0 | 101,0 | 106,0 | 105,0 | 101,0 | 105,0 | 103,0 | 98,5 | 103,0 | 102,0 | 102,0 | 102,0 | 102,0 | 102,0 | 102,0 | 102,0 | 102,0 | 102,0 | 24 | |
| 26 | 94,5 | 93,0 | 94,0 | 92,5 | 97,0 | 96,0 | 91,5 | 96,0 | 95,0 | 90,0 | 94,0 | 93,0 | 89,5 | 93,0 | 91,5 | 88,5 | 91,0 | 90,0 | 90,0 | 90,0 | 90,0 | 90,0 | 90,0 | 90,0 | 90,0 | 90,0 | 26 | |
| 28 | 85,5 | 84,0 | 84,5 | 83,0 | 87,0 | 86,0 | 82,5 | 86,0 | 85,0 | 80,5 | 84,0 | 83,0 | 80,0 | 83,0 | 81,5 | 79,0 | 81,0 | 80,0 | 80,0 | 80,0 | 80,0 | 80,0 | 80,0 | 80,0 | 80,0 | 80,0 | 28 | |
| 30 | 78,0 | 76,0 | 77,0 | 75,5 | 78,5 | 77,5 | 74,5 | 77,5 | 76,5 | 73,0 | 75,5 | 74,5 | 72,0 | 74,5 | 73,0 | 71,0 | 72,5 | 71,5 | 71,5 | 71,5 | 71,5 | 71,5 | 71,5 | 71,5 | 71,5 | 71,5 | 30 | |
| 33 | 68,5 | 67,0 | 67,6 | 66,1 | 68,7 | 67,3 | 65,1 | 67,3 | 66,3 | 63,2 | 65,7 | 64,3 | 62,6 | 64,3 | 62,8 | 61,6 | 62,0 | 61,2 | 61,2 | 61,2 | 61,2 | 61,2 | 61,2 | 61,2 | 61,2 | 61,2 | 33 | |
| 34 | - | 64,0 | 64,5 | 63,0 | 65,5 | 64,0 | 62,0 | 64,0 | 63,0 | 60,0 | 62,5 | 61,0 | 59,5 | 61,0 | 59,5 | 58,5 | 59,0 | 58,0 | 58,0 | 58,0 | 58,0 | 58,0 | 58,0 | 58,0 | 58,0 | 58,0 | 34 | |
| 38 | - | 54,5 | 55,0 | 53,5 | 55,0 | 54,0 | 52,5 | 54,0 | 53,0 | 50,5 | 52,0 | 51,0 | 50,0 | 50,5 | 49,6 | 48,9 | 49,1 | 48,0 | 48,0 | 48,0 | 48,0 | 48,0 | 48,0 | 48,0 | 48,0 | 48,0 | 38 | |
| 42 | - | - | 48,0 | 46,3 | 47,5 | 46,5 | 45,1 | 46,2 | 45,2 | 43,4 | 44,3 | 43,3 | 42,6 | 42,9 | 41,4 | 41,3 | 40,7 | 39,5 | 39,5 | 39,5 | 39,5 | 39,5 | 39,5 | 39,5 | 39,5 | 39,5 | 42 | |
| 43 | - | - | 46,5 | 44,8 | 45,9 | 44,9 | 43,5 | 44,6 | 43,6 | 41,9 | 42,6 | 41,6 | 41,1 | 41,1 | 39,5 | 39,7 | 38,8 | 37,7 | 37,7 | 37,7 | 37,7 | 37,7 | 37,7 | 37,7 | 37,7 | 37,7 | 43 | |
| 46 | - | - | - | 40,5 | 41,3 | 40,2 | 39,2 | 39,9 | 38,8 | 37,4 | 37,8 | 36,5 | 36,6 | 36,1 | 34,5 | 35,1 | 33,8 | 32,6 | 32,6 | 32,6 | 32,6 | 32,6 | 32,6 | 32,6 | 32,6 | 32,6 | 32,6 | 46 |
| 49 | - | - | - | 36,9 | 37,5 | 36,3 | 35,5 | 36,0 | 34,7 | 33,7 | 33,6 | 32,3 | 32,7 | 31,9 | 30,3 | 31,1 | 29,6 | 28,3 | 28,3 | 28,3 | 28,3 | 28,3 | 28,3 | 28,3 | 28,3 | 28,3 | 49 | |
| 50 | - | - | - | - | - | 35,1 | 34,3 | 34,7 | 33,4 | 32,5 | 32,3 | 31,0 | 31,4 | 30,5 | 28,9 | 29,8 | 28,2 | 26,9 | 26,9 | 26,9 | 26,9 | 26,9 | 26,9 | 26,9 | 26,9 | 26,9 | 50 | |
| 51 | - | - | - | - | - | 34,0 | 33,3 | 33,5 | 32,2 | 31,4 | 31,1 | 29,8 | 30,2 | 29,3 | 27,7 | 28,7 | 26,9 | 25,7 | 25,7 | 25,7 | 25,7 | 25,7 | 25,7 | 25,7 | 25,7 | 25,7 | 51 | |
| 54 | - | - | - | - | - | - | 30,4 | 30,2 | 28,9 | 28,2 | 27,8 | 26,4 | 25,9 | 24,4 | 25,2 | 23,5 | 21,5 | 20,2 | 20,2 | 20,2 | 20,2 | 20,2 | 20,2 | 20,2 | 20,2 | 20,2 | 54 | |
| 56 | - | - | - | - | - | - | - | 26,9 | 26,4 | 25,9 | 24,4 | 24,4 | 23,9 | 22,2 | 23,5 | 21,5 | 20,2 | 20,2 | 20,2 | 20,2 | 20,2 | 20,2 | 20,2 | 20,2 | 20,2 | 20,2 | 56 | |
| 58 | - | - | - | - | - | - | - | - | 24,7 | 24,0 | 22,6 | 23,4 | 22,0 | 20,3 | 21,7 | 19,5 | 18,3 | 18,3 | 18,3 | 18,3 | 18,3 | 18,3 | 18,3 | 18,3 | 18,3 | 18,3 | 58 | |
| 59 | - | - | - | - | - | - | - | - | 23,9 | 23,1 | 21,8 | 22,6 | 21,2 | 19,4 | 20,9 | 18,6 | 17,4 | 17,4 | 17,4 | 17,4 | 17,4 | 17,4 | 17,4 | 17,4 | 17,4 | 17,4 | 59 | |
| 62 | - | - | - | - | - | - | - | - | - | - | 19,4 | 20,4 | 18,8 | 17,0 | 18,6 | 16,2 | 14,9 | 14,9 | 14,9 | 14,9 | 14,9 | 14,9 | 14,9 | 14,9 | 14,9 | 14,9 | 62 | |
| 64 | - | - | - | - | - | - | - | - | - | - | - | 19,1 | 17,3 | 15,6 | 17,2 | 14,7 | 13,4 | 13,4 | 13,4 | 13,4 | 13,4 | 13,4 | 13,4 | 13,4 | 13,4 | 13,4 | 64 | |
| 66 | - | - | - | - | - | - | - | - | - | - | - | - | - | - | 14,3 | 15,9 | 13,3 | 12,0 | 12,0 | 12,0 | 12,0 | 12,0 | 12,0 | 12,0 | 12,0 | 12,0 | 66 | |
| 67 | - | - | - | - | - | - | - | - | - | - | - | - | - | - | 13,6 | 15,3 | 12,7 | 11,3 | 11,3 | 11,3 | 11,3 | 11,3 | 11,3 | 11,3 | 11,3 | 11,3 | 67 | |
| 69 | - | - | - | - | - | - | - | - | - | - | - | - | - | - | - | 14,2 | 11,5 | 10,1 | 10,1 | 10,1 | 10,1 | 10,1 | 10,1 | 10,1 | 10,1 | 10,1 | 69 | |
| 70 | - | - | - | - | - | - | - | - | - | - | - | - | - | - | - | - | 9,6 | 9,6 | 9,6 | 9,6 | 9,6 | 9,6 | 9,6 | 9,6 | 9,6 | 9,6 | 70 | |
| 72 | - | - | - | - | - | - | - | - | - | - | - | - | - | - | - | - | - | 8,5 | 8,5 | 8,5 | 8,5 | 8,5 | 8,5 | 8,5 | 8,5 | 8,5 | 72 | |

185 t
205 t
225 t

30 t
50 t

| m | t | t | t | t | t | t | t | t | t | t | t | t | t | t | t | t | t | t | m |
|----|-------|-------|-------|-------|-------|-------|-------|-------|-------|-------|-------|-------|-------|-------|-------|-------|-------|---|----|
| 11 | 207,0 | 239,0 | 233,0 | 191,0 | 231,0 | - | - | - | - | - | - | - | - | - | - | - | - | - | 11 |
| 12 | 197,0 | 219,0 | 214,0 | 187,0 | 212,0 | 208,0 | 160,0 | 204,0 | 199,0 | 146,0 | 195,0 | - | - | - | - | - | - | - | 12 |
| 13 | 183,5 | 203,0 | 198,5 | 175,0 | 197,0 | 193,0 | 157,5 | 189,5 | 185,0 | 143,5 | 181,5 | 177,0 | 135,0 | 173,0 | 156,0 | 123,0 | 147,0 | - | 13 |
| 14 | 170,0 | 187,0 | 183,0 | 163,0 | 182,0 | 178,0 | 155,0 | 175,0 | 171,0 | 141,0 | 168,0 | 164,0 | 134,0 | 161,0 | 153,0 | 122,0 | 144,0 | - | 14 |
| 16 | 149,0 | 162,0 | 158,0 | 143,0 | 158,0 | 155,0 | 138,0 | 152,0 | 149,0 | 132,0 | 146,0 | 143,0 | 127,0 | 140,0 | 140,0 | 119,0 | 137,0 | - | 16 |
| 18 | 132,0 | 142,0 | 139,0 | 126,0 | 139,0 | 136,0 | 122,0 | 134,0 | 131,0 | 117,0 | 128,0 | 126,0 | 112,0 | 123,0 | 124,0 | 108,0 | 122,0 | - | 18 |
| 20 | 118,0 | 126,0 | 123,0 | 113,0 | 124,0 | 121,0 | 109,0 | 119,0 | 116,0 | 105,0 | 114,0 | 111,0 | 101,0 | 109,0 | 110,0 | 96,5 | 108,0 | - | 20 |
| 22 | 106,0 | 112,0 | 110,0 | 102,0 | 111,0 | 108,0 | 98,5 | 106,0 | 104,0 | 94,5 | 102,0 | 100,0 | 90,5 | 98,0 | 99,0 | 86,5 | 97,0 | - | 22 |
| 24 | 96,0 | 101,0 | 99,0 | 92,0 | 100,0 | 97,5 | 89,0 | 96,0 | 93,5 | 85,5 | 91,5 | 89,5 | 82,0 | 88,0 | 89,0 | 78,5 | 87,5 | - | 24 |
| 26 | 87,5 | 90,0 | 89,0 | 84,0 | 90,5 | 88,5 | 81,0 | 86,5 | 84,5 | 77,5 | 83,0 | 80,5 | 74,5 | 79,0 | 80,5 | 71,0 | 79,0 | - | 26 |
| 28 | 79,0 | 80,0 | 79,0 | 76,5 | 80,5 | 79,5 | 74,0 | 78,5 | 76,5 | 71,0 | 75,0 | 73,0 | 67,5 | 71,5 | 73,0 | 64,5 | 71,5 | - | 28 |
| 30 | 71,0 | 71,5 | 70,5 | 69,5 | 72,0 | 71,0 | 68,0 | 71,0 | 70,0 | 65,0 | 68,0 | 66,5 | 62,0 | 65,0 | 66,5 | 59,0 | 65,0 | - | 30 |
| 34 | 58,5 | 58,0 | 57,0 | 57,0 | 58,5 | 57,5 | 56,5 | 57,5 | 56,5 | 54,5 | 55,5 | 54,5 | 52,0 | 53,5 | 55,5 | 49,3 | 54,0 | - | 34 |
| 38 | 48,9 | 47,8 | 46,7 | 47,4 | 48,4 | 47,3 | 47,0 | 47,1 | 46,0 | 45,5 | 45,0 | 43,8 | 44,2 | 43,8 | 45,7 | 41,5 | 45,0 | - | 38 |
| 42 | 41,3 | 39,2 | 38,1 | 39,7 | 39,8 | 38,6 | 39,2 | 38,4 | 37,3 | 37,4 | 36,3 | 35,2 | 36,4 | 35,1 | 37,0 | 34,7 | 36,3 | - | 42 |
| 46 | 35,1 | 32,3 | 31,1 | 33,2 | 32,8 | 31,7 | 32,7 | 31,5 | 30,3 | 30,9 | 29,3 | 28,2 | 29,9 | 28,1 | 30,0 | 28,1 | 29,2 | - | 46 |
| 50 | 29,7 | 26,6 | 25,4 | 27,9 | 27,1 | 26,0 | 27,3 | 25,7 | 24,6 | 25,5 | 23,6 | 22,4 | 24,5 | 22,3 | 24,2 | 22,6 | 23,5 | - | 50 |
| 54 | 25,3 | 21,9 | 20,7 | 23,4 | 22,4 | 21,2 | 22,8 | 20,9 | 19,8 | 21,0 | 18,8 | 17,6 | 19,9 | 17,4 | 19,4 | 18,1 | 18,6 | - | 54 |
| 58 | 21,6 | 17,9 | 16,7 | 19,7 | 18,4 | 17,2 | 19,0 | 16,9 | 15,7 | 17,2 | 14,7 | 13,5 | 16,1 | 13,4 | 15,3 | 14,3 | 14,5 | - | 58 |
| 62 | 18,4 | 14,5 | 13,2 | 16,4 | 14,9 | 13,7 | 15,8 | 13,4 | 12,2 | 13,9 | 11,2 | 10,0 | 12,8 | 9,8 | 11,8 | 11,0 | 11,0 | - | 62 |
| 66 | 15,7 | 11,6 | 10,3 | 13,7 | 12,0 | 10,8 | 13,0 | 10,4 | 9,2 | 11,1 | 8,2 | 7,0 | 10,0 | 6,8 | 8,7 | 8,1 | 7,9 | - | 66 |
| 70 | 13,3 | 9,0 | 7,8 | 11,3 | 9,4 | 8,2 | 10,6 | 7,8 | 6,6 | 8,7 | 5,6 | 4,4 | 7,5 | 4,1 | 6,1 | 5,6 | 5,3 | - | 70 |
| 72 | 12,3 | 7,9 | 6,6 | 10,2 | 8,3 | 7,0 | 9,5 | 6,6 | 5,4 | 7,6 | 4,4 | - | 6,4 | - | - | 4,5 | 4,1 | - | 72 |
| 74 | 11,3 | 6,9 | 5,6 | 9,2 | 7,2 | 6,0 | 8,4 | 5,5 | 4,3 | 6,5 | - | - | 5,3 | - | - | - | - | - | 74 |
| 75 | 10,8 | 6,4 | 5,1 | 8,7 | 6,7 | 5,5 | 7,9 | 5,0 | - | 6,0 | - | - | 4,8 | - | - | - | - | - | 75 |
| 76 | - | - | 4,6 | 8,3 | 6,2 | 5,0 | 7,5 | 4,5 | - | 5,5 | - | - | 4,3 | - | - | - | - | - | 76 |
| 77 | - | - | 4,1 | 7,9 | 5,7 | 4,5 | 7,0 | 4,0 | - | 5,0 | - | - | - | - | - | - | - | - | 77 |
| 78 | - | - | - | 7,5 | 5,3 | 4,0 | 6,6 | - | - | 4,6 | - | - | - | - | - | - | - | - | 78 |
| 79 | - | - | - | 7,1 | 4,8 | - | 6,1 | - | - | 4,2 | - | - | - | - | - | - | - | - | 79 |
| 80 | - | - | - | 6,7 | 4,4 | - | 5,7 | - | - | - | - | - | - | - | - | - | - | - | 80 |
| 82 | - | - | - | - | - | - | 4,9 | - | - | - | - | - | - | - | - | - | - | - | 82 |
| 84 | - | - | - | - | - | - | 4,2 | - | - | - | - | - | - | - | - | - | - | - | 84 |

| <div style="display: flex; justify-content: space-between; align-items: center;"> <div style="text-align: center;"> 8,40 m </div> <div style="text-align: center;"> 9.8 m/s </div> <div style="text-align: center;"> 360° </div> <div style="text-align: right;"> ISO </div> </div> | | | | | | | | | | | | | | | | | | | | |
|--|-------|-------|-------|-------|-------|-------|-------|-------|-------|-------|-------|-------|-------|-------|-------|-------|-------|-------|-------|----|
| <div style="display: flex; justify-content: space-between; align-items: center;"> <div style="text-align: center;"> </div> <div style="display: flex; justify-content: space-between; width: 100%;"> 36m42m48m54 m57m60 m63m66 m69m72 m75m78 m81m </div> <div style="text-align: right;"> </div> </div> | | | | | | | | | | | | | | | | | | | | |
| <div style="display: flex; justify-content: space-between; align-items: center;"> <div style="text-align: center;"> </div> <div style="display: flex; justify-content: space-between; width: 100%;"> LH_1LH_5LH_1LH_5LH_1LH_5LH_1LH_5LH_1LH_5LH_1LH_5 </div> <div style="text-align: right;"> </div> </div> | | | | | | | | | | | | | | | | | | | | |
| m | t | t | t | t | t | t | t | t | t | t | t | t | t | t | t | t | t | t | t | m |
| 7 | 347,0 | 347,0 | - | - | - | - | - | - | - | - | - | - | - | - | - | - | - | - | - | 7 |
| 8 | 347,0 | 338,0 | 318,0 | 297,0 | 316,0 | 306,0 | - | - | - | - | - | - | - | - | - | - | - | - | - | 8 |
| 9 | 315,0 | 295,0 | 279,0 | 263,0 | 277,0 | 269,0 | 248,0 | 262,0 | 254,0 | 234,0 | 247,0 | 241,0 | - | - | - | - | - | - | - | 9 |
| 10 | 277,0 | 261,0 | 248,0 | 235,0 | 246,0 | 239,0 | 222,0 | 233,0 | 227,0 | 211,0 | 221,0 | 215,0 | 200,0 | 210,0 | 204,0 | 190,0 | 199,0 | 194,0 | 194,0 | 10 |
| 12 | 223,0 | 211,0 | 203,0 | 193,0 | 199,0 | 195,0 | 184,0 | 190,0 | 186,0 | 175,0 | 181,0 | 177,0 | 167,0 | 173,0 | 168,0 | 159,0 | 164,0 | 160,0 | 160,0 | 12 |
| 14 | 182,0 | 176,0 | 171,0 | 163,0 | 167,0 | 163,0 | 156,0 | 160,0 | 156,0 | 149,0 | 152,0 | 149,0 | 142,0 | 146,0 | 142,0 | 136,0 | 139,0 | 135,0 | 135,0 | 14 |
| 16 | 148,0 | 147,0 | 147,0 | 141,0 | 143,0 | 139,0 | 134,0 | 137,0 | 134,0 | 129,0 | 131,0 | 128,0 | 123,0 | 125,0 | 122,0 | 118,0 | 119,0 | 116,0 | 116,0 | 16 |
| 18 | 124,0 | 123,0 | 123,0 | 122,0 | 119,0 | 118,0 | 118,0 | 119,0 | 116,0 | 113,0 | 114,0 | 111,0 | 108,0 | 109,0 | 106,0 | 104,0 | 103,0 | 101,0 | 101,0 | 18 |
| 20 | 106,0 | 105,0 | 106,0 | 104,0 | 101,0 | 100,0 | 103,0 | 101,0 | 100,0 | 100,0 | 99,0 | 97,5 | 96,5 | 95,5 | 93,0 | 92,0 | 91,0 | 88,5 | 88,5 | 20 |
| 22 | 92,5 | 91,0 | 92,0 | 90,5 | 87,5 | 87,0 | 89,5 | 87,0 | 86,0 | 88,5 | 85,0 | 84,0 | 86,0 | 84,0 | 82,5 | 82,0 | 80,0 | 78,0 | 78,0 | 22 |
| 24 | 81,5 | 80,0 | 81,0 | 79,5 | 76,5 | 75,5 | 78,5 | 75,5 | 75,0 | 77,0 | 74,0 | 73,0 | 76,5 | 73,0 | 71,5 | 74,0 | 71,0 | 69,5 | 69,5 | 24 |
| 26 | 72,5 | 71,0 | 72,0 | 70,5 | 67,5 | 66,5 | 69,5 | 66,5 | 65,5 | 68,0 | 65,0 | 64,0 | 67,5 | 63,5 | 62,5 | 66,5 | 62,0 | 61,0 | 61,0 | 26 |
| 28 | 65,5 | 64,0 | 64,5 | 63,0 | 60,0 | 59,0 | 62,0 | 59,0 | 58,0 | 60,5 | 57,5 | 56,5 | 60,0 | 56,0 | 55,0 | 59,0 | 54,5 | 53,5 | 53,5 | 28 |
| 30 | 59,0 | 57,5 | 58,5 | 57,0 | 54,0 | 53,0 | 56,0 | 53,0 | 52,0 | 54,0 | 51,0 | 50,0 | 53,5 | 50,0 | 48,7 | 52,5 | 48,2 | 47,1 | 47,1 | 30 |
| 33 | 51,5 | 50,3 | 51,0 | 49,5 | 46,5 | 45,5 | 48,5 | 45,5 | 44,5 | 46,8 | 43,5 | 42,5 | 46,0 | 42,2 | 40,7 | 45,0 | 39,9 | 38,8 | 38,8 | 33 |
| 34 | - | 48,0 | 48,6 | 47,0 | 44,1 | 43,1 | 46,0 | 43,0 | 42,0 | 44,4 | 41,1 | 40,0 | 43,6 | 39,6 | 38,1 | 42,5 | 37,5 | 36,3 | 36,3 | 34 |
| 38 | - | 40,6 | 41,1 | 39,5 | 36,6 | 35,5 | 38,4 | 35,3 | 34,1 | 36,7 | 33,1 | 31,8 | 36,0 | 31,5 | 29,9 | 34,5 | 29,3 | 28,1 | 28,1 | 38 |
| 42 | - | - | 35,4 | 33,7 | 30,5 | 29,2 | 32,4 | 29,0 | 27,8 | 30,5 | 26,7 | 25,5 | 29,6 | 25,1 | 23,5 | 28,1 | 22,8 | 21,6 | 21,6 | 42 |
| 43 | - | - | 34,2 | 32,5 | 29,3 | 27,9 | 31,1 | 27,7 | 26,5 | 29,2 | 25,4 | 24,2 | 28,3 | 23,7 | 22,1 | 26,8 | 21,4 | 20,3 | 20,3 | 43 |
| 46 | - | - | - | 29,0 | 25,7 | 24,3 | 27,5 | 24,0 | 22,7 | 25,5 | 21,7 | 20,4 | 24,5 | 19,9 | 18,3 | 22,9 | 17,7 | 16,4 | 16,4 | 46 |
| 49 | - | - | - | 26,1 | 22,7 | 21,3 | 24,5 | 20,9 | 19,7 | 22,4 | 18,5 | 17,3 | 21,3 | 16,8 | 15,1 | 19,7 | 14,4 | 13,2 | 13,2 | 49 |
| 50 | - | - | - | - | - | 20,4 | 23,5 | 19,9 | 18,7 | 21,4 | 17,6 | 16,3 | 20,3 | 15,8 | 14,1 | 18,7 | 13,4 | 12,2 | 12,2 | 50 |
| 51 | - | - | - | - | - | 19,6 | 22,6 | 19,0 | 17,8 | 20,5 | 16,7 | 15,4 | 19,4 | 14,9 | 13,2 | 17,8 | 12,5 | 11,2 | 11,2 | 51 |
| 54 | - | - | - | - | - | - | 20,2 | 16,7 | 15,3 | 18,0 | 14,2 | 12,9 | 16,9 | 12,3 | 10,7 | 15,2 | 9,9 | 8,7 | 8,7 | 54 |
| 56 | - | - | - | - | - | - | - | - | 13,9 | 16,6 | 12,8 | 11,4 | 15,4 | 10,8 | 9,2 | 13,7 | 8,4 | 7,2 | 7,2 | 56 |
| 58 | - | - | - | - | - | - | - | - | - | 15,2 | 11,4 | 10,1 | 14,0 | 9,5 | 7,8 | 12,3 | 7,0 | 5,7 | 5,7 | 58 |
| 59 | - | - | - | - | - | - | - | - | - | 14,6 | 10,8 | 9,5 | 13,4 | 8,9 | 7,2 | 11,6 | 6,3 | 5,0 | 5,0 | 59 |
| 60 | - | - | - | - | - | - | - | - | - | - | - | 8,9 | 12,8 | 8,3 | 6,6 | 11,0 | 5,7 | 4,4 | 4,4 | 60 |
| 62 | - | - | - | - | - | - | - | - | - | - | - | 7,8 | 11,6 | 7,1 | 5,4 | 9,8 | 4,5 | - | - | 62 |
| 64 | - | - | - | - | - | - | - | - | - | - | - | - | 10,6 | 6,0 | 4,3 | 8,7 | - | - | - | 64 |
| 66 | - | - | - | - | - | - | - | - | - | - | - | - | - | - | - | 7,7 | - | - | - | 66 |
| 69 | - | - | - | - | - | - | - | - | - | - | - | - | - | - | - | 6,4 | - | - | - | 69 |

125 t 165 t

| | | 8,40 m | | | | | | | | | | | | | | | | 9.8 m/s | | 360° | | ISO | | | |
|----|-------|--------|-------|-------|-------|-------|-------|-------|-------|-------|-------|-------|-------|-------|-------|-------|-------|---------|-------|-------|-------|-------|-------|-------|----|
| | | 84 m | | 87 m | | 90 m | | 93 m | | 96 m | | 99 m | | 102 m | | 105 m | | 108 m | | 111 m | | 114 m | | | |
| | | LH_1 | | LH_5 | | LH_1 | | LH_5 | | LH_1 | | LH_5 | | LH_1 | | LH_5 | | LH_1 | | LH_5 | | LH_1 | | LH_5 | |
| m | t | t | t | t | t | t | t | t | t | t | t | t | t | t | t | t | t | t | t | t | t | t | t | t | m |
| 11 | 166,0 | 172,0 | 168,0 | 158,0 | 166,0 | - | - | - | - | - | - | - | - | - | - | - | - | - | - | - | - | - | - | - | 11 |
| 12 | 153,0 | 157,0 | 153,0 | 146,0 | 152,0 | 148,0 | 140,0 | 145,0 | 142,0 | 133,0 | 138,0 | - | - | - | - | - | - | - | - | - | - | - | - | - | 12 |
| 13 | 142,0 | 145,0 | 141,0 | 135,5 | 140,5 | 137,0 | 130,0 | 134,0 | 131,0 | 124,0 | 128,0 | 124,0 | 118,0 | 121,0 | 122,0 | 112,0 | 112,0 | 119,0 | 119,0 | 119,0 | 119,0 | 119,0 | 119,0 | 119,0 | 13 |
| 14 | 131,0 | 133,0 | 129,0 | 125,0 | 129,0 | 126,0 | 120,0 | 123,0 | 120,0 | 115,0 | 118,0 | 115,0 | 109,0 | 112,0 | 112,0 | 104,0 | 110,0 | 110,0 | 110,0 | 110,0 | 110,0 | 110,0 | 110,0 | 110,0 | 14 |
| 16 | 114,0 | 114,0 | 111,0 | 109,0 | 111,0 | 108,0 | 105,0 | 106,0 | 104,0 | 100,0 | 101,0 | 99,0 | 95,5 | 96,5 | 97,5 | 91,0 | 95,0 | 95,0 | 95,0 | 95,0 | 95,0 | 95,0 | 95,0 | 95,0 | 16 |
| 18 | 100,0 | 99,0 | 96,5 | 96,0 | 97,0 | 94,5 | 92,5 | 92,5 | 90,5 | 88,0 | 88,0 | 86,0 | 84,0 | 84,0 | 85,0 | 80,0 | 83,0 | 83,0 | 83,0 | 83,0 | 83,0 | 83,0 | 83,0 | 83,0 | 18 |
| 20 | 89,5 | 86,5 | 84,5 | 85,5 | 85,5 | 83,0 | 82,0 | 81,5 | 79,0 | 78,0 | 77,0 | 75,0 | 74,5 | 73,5 | 74,5 | 70,5 | 73,0 | 73,0 | 73,0 | 73,0 | 73,0 | 73,0 | 73,0 | 73,0 | 20 |
| 22 | 80,0 | 76,5 | 74,5 | 76,0 | 75,5 | 73,5 | 73,5 | 72,0 | 69,5 | 70,0 | 68,0 | 66,0 | 66,5 | 64,5 | 65,5 | 63,0 | 64,0 | 64,0 | 64,0 | 64,0 | 64,0 | 64,0 | 64,0 | 64,0 | 22 |
| 24 | 72,0 | 68,0 | 66,0 | 68,5 | 67,0 | 65,0 | 66,0 | 63,5 | 62,0 | 62,5 | 60,0 | 58,0 | 59,5 | 56,5 | 58,0 | 56,0 | 56,5 | 56,5 | 56,5 | 56,5 | 56,5 | 56,5 | 56,5 | 56,5 | 24 |
| 26 | 65,0 | 60,5 | 58,5 | 62,0 | 60,0 | 58,0 | 59,5 | 56,5 | 55,0 | 56,0 | 53,5 | 51,5 | 53,5 | 50,0 | 51,5 | 50,0 | 50,5 | 50,5 | 50,5 | 50,5 | 50,5 | 50,5 | 50,5 | 50,5 | 26 |
| 28 | 59,0 | 53,5 | 52,5 | 56,0 | 53,5 | 52,0 | 53,5 | 50,5 | 49,2 | 50,5 | 47,6 | 45,9 | 48,1 | 44,6 | 46,2 | 45,1 | 44,9 | 44,9 | 44,9 | 44,9 | 44,9 | 44,9 | 44,9 | 44,9 | 28 |
| 30 | 52,5 | 47,0 | 45,8 | 51,0 | 47,6 | 46,4 | 48,9 | 45,6 | 43,9 | 46,1 | 42,4 | 40,8 | 43,4 | 39,5 | 41,2 | 40,5 | 40,0 | 40,0 | 40,0 | 40,0 | 40,0 | 40,0 | 40,0 | 40,0 | 30 |
| 34 | 42,5 | 36,1 | 34,9 | 41,0 | 36,7 | 35,5 | 40,5 | 35,4 | 34,3 | 37,9 | 33,3 | 32,2 | 35,4 | 31,0 | 32,9 | 32,8 | 31,7 | 31,7 | 31,7 | 31,7 | 31,7 | 31,7 | 31,7 | 31,7 | 34 |
| 38 | 34,5 | 27,8 | 26,7 | 32,7 | 28,4 | 27,3 | 32,2 | 27,1 | 25,9 | 30,5 | 25,0 | 23,8 | 29,0 | 23,8 | 25,7 | 26,4 | 25,0 | 25,0 | 25,0 | 25,0 | 25,0 | 25,0 | 25,0 | 25,0 | 38 |
| 42 | 28,1 | 21,4 | 20,2 | 26,3 | 21,9 | 20,7 | 25,7 | 20,6 | 19,4 | 24,0 | 18,5 | 17,3 | 23,0 | 17,2 | 19,1 | 21,2 | 18,4 | 18,4 | 18,4 | 18,4 | 18,4 | 18,4 | 18,4 | 18,4 | 42 |
| 46 | 22,9 | 16,2 | 15,0 | 21,0 | 16,7 | 15,5 | 20,5 | 15,3 | 14,1 | 18,7 | 13,2 | 12,0 | 17,7 | 11,9 | 13,8 | 15,9 | 13,1 | 13,1 | 13,1 | 13,1 | 13,1 | 13,1 | 13,1 | 13,1 | 46 |
| 50 | 18,6 | 11,9 | 10,7 | 16,8 | 12,4 | 11,2 | 16,2 | 11,0 | 9,8 | 14,4 | 8,8 | 7,7 | 13,4 | 7,5 | 9,5 | 11,5 | 8,7 | 8,7 | 8,7 | 8,7 | 8,7 | 8,7 | 8,7 | 8,7 | 50 |
| 53 | 15,9 | 9,2 | 8,0 | 14,1 | 9,7 | 8,5 | 13,5 | 8,3 | 7,1 | 11,7 | 6,1 | 4,9 | 10,6 | 4,7 | 6,7 | 8,8 | 6,0 | 6,0 | 6,0 | 6,0 | 6,0 | 6,0 | 6,0 | 6,0 | 53 |
| 54 | 15,1 | 8,3 | 7,1 | 13,2 | 8,8 | 7,6 | 12,6 | 7,4 | 6,2 | 10,8 | 5,2 | 4,0 | 9,7 | - | 5,8 | 7,9 | 5,1 | 5,1 | 5,1 | 5,1 | 5,1 | 5,1 | 5,1 | 5,1 | 54 |
| 55 | 14,3 | 7,5 | 6,3 | 12,4 | 8,0 | 6,8 | 11,8 | 6,6 | 5,4 | 10,0 | 4,4 | - | 8,9 | - | 5,0 | 7,1 | 4,2 | 4,2 | 4,2 | 4,2 | 4,2 | 4,2 | 4,2 | 4,2 | 55 |
| 56 | 13,6 | 6,8 | 5,6 | 11,7 | 7,3 | 6,1 | 11,0 | 5,8 | 4,6 | 9,3 | - | - | 8,2 | - | 4,2 | 6,3 | - | - | - | - | - | - | - | - | 56 |
| 58 | 12,1 | 5,3 | 4,1 | 10,2 | 5,8 | 4,6 | 9,6 | 4,3 | - | 7,8 | - | - | 6,7 | - | - | 4,8 | - | - | - | - | - | - | - | - | 58 |
| 59 | 11,4 | 4,6 | - | 9,5 | 5,1 | - | 8,9 | - | - | 7,1 | - | - | 6,0 | - | - | 4,1 | - | - | - | - | - | - | - | - | 59 |
| 60 | 10,8 | 4,0 | - | 8,9 | 4,5 | - | 8,3 | - | - | 6,4 | - | - | 5,3 | - | - | - | - | - | - | - | - | - | - | - | 60 |
| 62 | 9,6 | - | - | 7,7 | - | - | 7,0 | - | - | 5,1 | - | - | 4,0 | - | - | - | - | - | - | - | - | - | - | - | 62 |
| 63 | 9,0 | - | - | 7,1 | - | - | 6,4 | - | - | 4,6 | - | - | - | - | - | - | - | - | - | - | - | - | - | - | 63 |
| 66 | 7,4 | - | - | 5,5 | - | - | 4,8 | - | - | - | - | - | - | - | - | - | - | - | - | - | - | - | - | - | 66 |
| 67 | 6,9 | - | - | 5,0 | - | - | 4,3 | - | - | - | - | - | - | - | - | - | - | - | - | - | - | - | - | - | 67 |
| 69 | 6,0 | - | - | 4,0 | - | - | - | - | - | - | - | - | - | - | - | - | - | - | - | - | - | - | - | - | 69 |
| 70 | 5,6 | - | - | - | - | - | - | - | - | - | - | - | - | - | - | - | - | - | - | - | - | - | - | - | 70 |
| 74 | 4,0 | - | - | - | - | - | - | - | - | - | - | - | - | - | - | - | - | - | - | - | - | - | - | - | 74 |

165 t

Notes

CC 3800-1

Notizen · Notes · Nota · Notas · Notas ·
пометы, комментарии, примечания

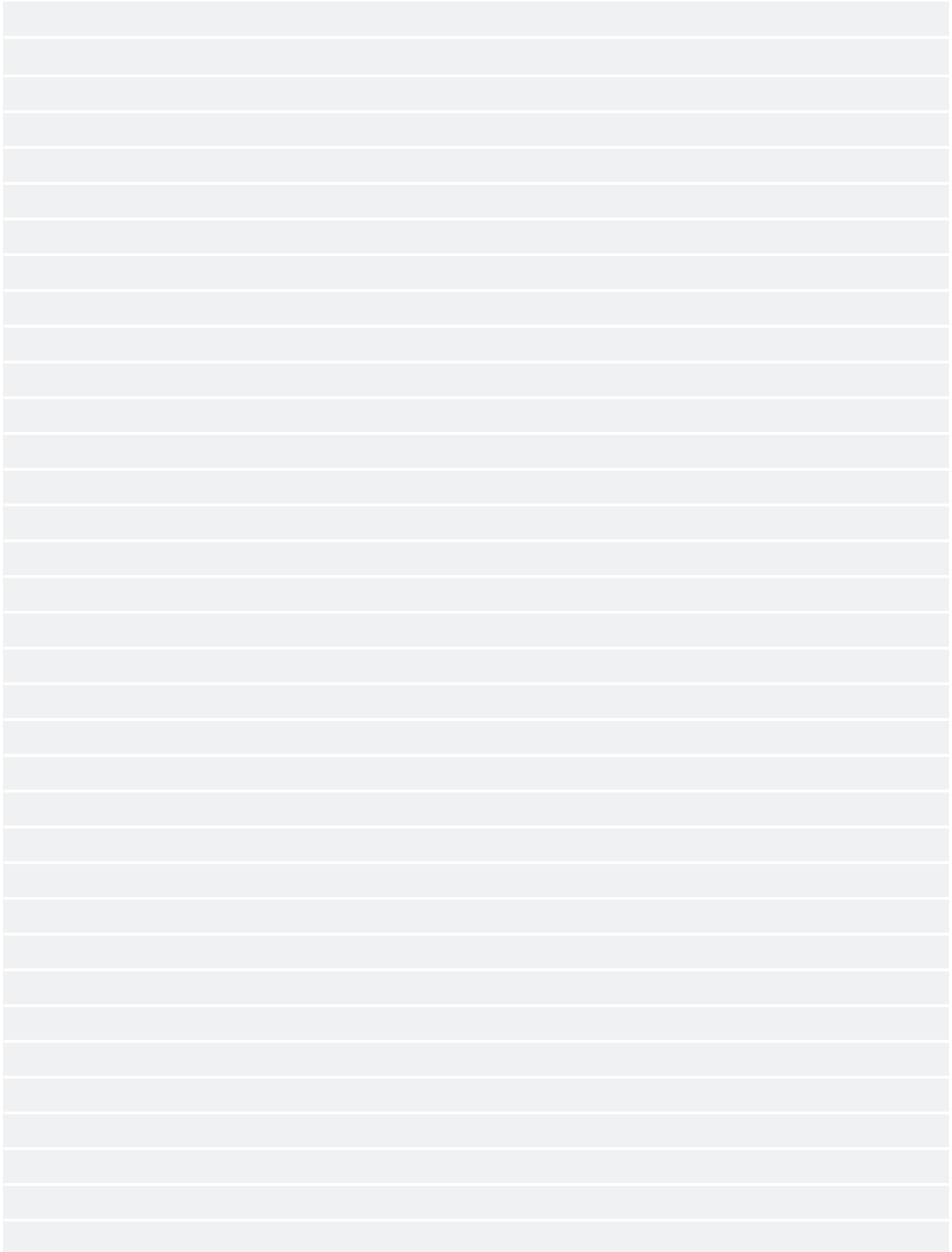

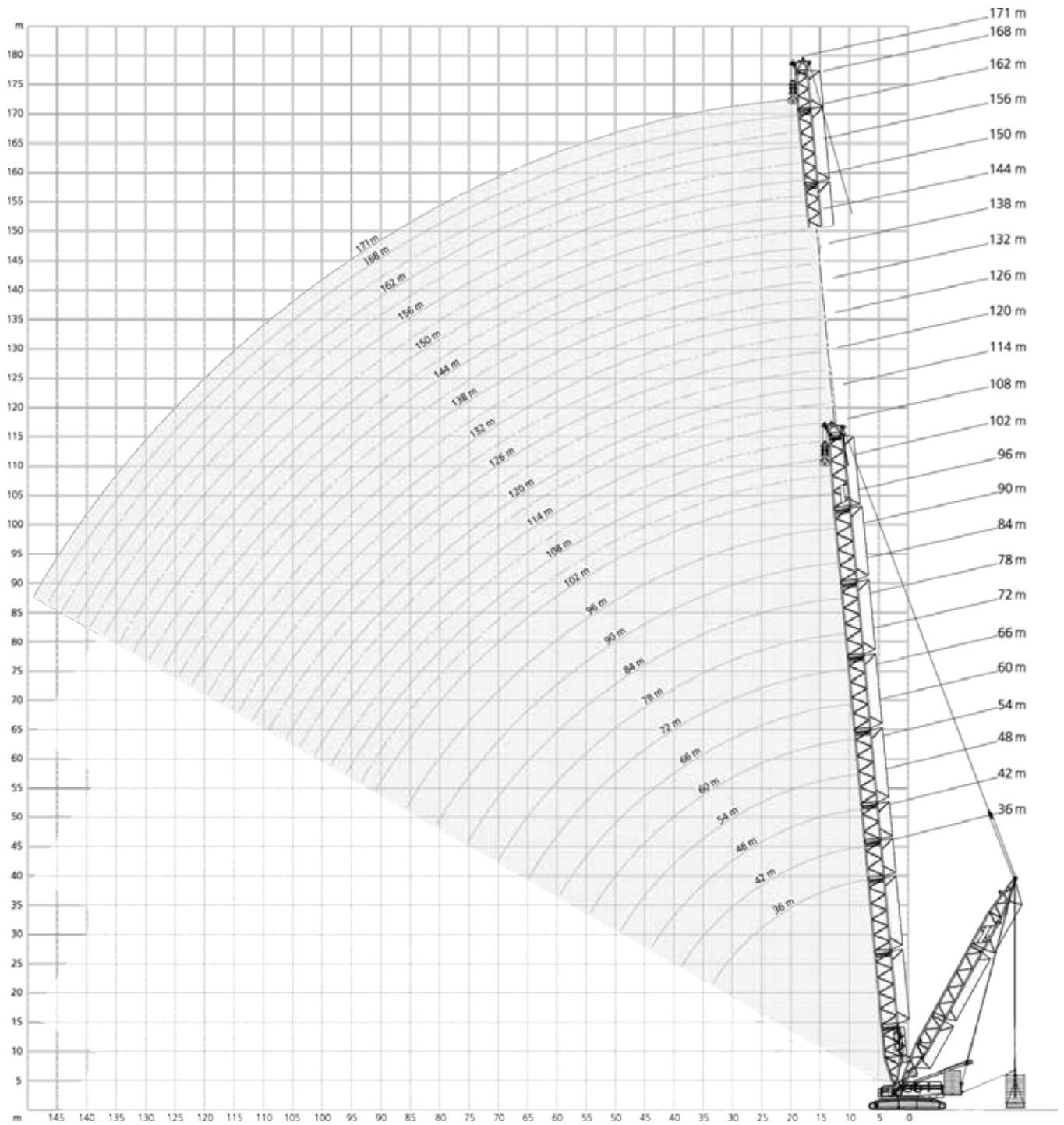

| 225 t + 50 t | | 11-19 m | | | 8,40 m | | 9.8 m/s | | 360° | | ISO | |
|--------------|-------|---------|---|---------|--------|-------|---------|---------|-------|----|-----|--|
| | | 42 m | | | | 48 m | | | | | | |
| | | SSL_2 | | SSL_3 | | SSL_2 | | SSL_3 | | | | |
| | | 0 t | | 0t-325t | | 0 t | | 0t-325t | | | | |
| m | t | t | t | t | t | t | t | t | t | m | | |
| 8 | 486,0 | 650,0 | - | - | 482,0 | 650,0 | 650,0 | 650,0 | 650,0 | 8 | | |
| 9 | 443,0 | 650,0 | - | - | 427,0 | 650,0 | 650,0 | 650,0 | 650,0 | 9 | | |
| 10 | 398,0 | 628,0 | - | - | 382,0 | 650,0 | 650,0 | 650,0 | 650,0 | 10 | | |
| 11 | 359,5 | 584,0 | - | - | 345,5 | 614,0 | 614,0 | 614,0 | 614,0 | 11 | | |
| 12 | 324,0 | 581,0 | - | - | 313,0 | 618,0 | 618,0 | 618,0 | 618,0 | 12 | | |
| 14 | 269,0 | 546,0 | - | - | 265,0 | 578,0 | 577,0 | 577,0 | 577,0 | 14 | | |
| 15 | 245,0 | 547,0 | - | - | 246,0 | 578,0 | 577,0 | 577,0 | 577,0 | 15 | | |
| 16 | 222,0 | 517,0 | - | - | 223,0 | 546,0 | 546,0 | 546,0 | 546,0 | 16 | | |
| 18 | 188,0 | 495,0 | - | - | 187,0 | 492,0 | 491,0 | 491,0 | 491,0 | 18 | | |
| 20 | 161,0 | 450,0 | - | - | 160,0 | 447,0 | 446,0 | 446,0 | 446,0 | 20 | | |
| 22 | 141,0 | 412,0 | - | - | 139,0 | 409,0 | 408,0 | 408,0 | 408,0 | 22 | | |
| 24 | 124,0 | 379,0 | - | - | 122,0 | 377,0 | 376,0 | 376,0 | 376,0 | 24 | | |
| 26 | 111,0 | 352,0 | - | - | 109,0 | 349,0 | 348,0 | 348,0 | 348,0 | 26 | | |
| 28 | 100,0 | 322,0 | - | - | 98,0 | 324,0 | 323,0 | 323,0 | 323,0 | 28 | | |
| 30 | 91,0 | 290,0 | - | - | 89,0 | 301,0 | 300,0 | 300,0 | 300,0 | 30 | | |
| 34 | 77,3 | 240,3 | - | - | 75,0 | 260,3 | 260,0 | 260,0 | 260,0 | 34 | | |
| 38 | 65,0 | 201,0 | - | - | 63,5 | 220,3 | 220,0 | 220,0 | 220,0 | 38 | | |
| 42 | - | - | - | - | 54,5 | 186,0 | 186,0 | 186,0 | 186,0 | 42 | | |
| 44 | - | - | - | - | 51,0 | 169,0 | 169,0 | 169,0 | 169,0 | 44 | | |

| 225 t + 50 t | | 11-19 m | | | | 8,40 m | | 9.8 m/s | | 360° | | ISO | |
|--------------|-------|---------|---------|-------|-------|--------|-------|---------|-------|-------|----|-----|--|
| | | 54 m | | | | 60 m | | | | | | | |
| | | SSL_1 | SSL_2 | SSL_3 | SSL_4 | SSL_1 | SSL_2 | SSL_3 | SSL_4 | | | | |
| | | 0 t | 0t-325t | | | | 0 t | 0t-325t | | | | | |
| m | t | t | t | t | t | t | t | t | t | t | m | | |
| 8 | 434,0 | 650,0 | 632,0 | 632,0 | - | - | - | - | - | - | 8 | | |
| 9 | 384,0 | 650,0 | 632,0 | 632,0 | - | 366,0 | 571,0 | 571,0 | 571,0 | 571,0 | 9 | | |
| 10 | 344,0 | 650,0 | 632,0 | 632,0 | - | 333,0 | 571,0 | 571,0 | 571,0 | 571,0 | 10 | | |
| 11 | 317,0 | 650,0 | 624,0 | 632,0 | - | 304,5 | 571,0 | 571,0 | 571,0 | 571,0 | 11 | | |
| 12 | 289,0 | 650,0 | 632,0 | 632,0 | - | 276,0 | 571,0 | 571,0 | 571,0 | 571,0 | 12 | | |
| 14 | 245,0 | 576,0 | 611,0 | 610,0 | - | 234,0 | 571,0 | 571,0 | 571,0 | 571,0 | 14 | | |
| 16 | 212,0 | 512,0 | 544,0 | 543,0 | - | 203,0 | 510,0 | 542,0 | 541,0 | 540,0 | 16 | | |
| 18 | 184,0 | 461,0 | 489,0 | 489,0 | - | 178,0 | 458,0 | 487,0 | 486,0 | 485,0 | 18 | | |
| 20 | 158,0 | 418,0 | 444,0 | 444,0 | - | 156,0 | 416,0 | 442,0 | 441,0 | 440,0 | 20 | | |
| 22 | 137,0 | 383,0 | 406,0 | 406,0 | - | 135,0 | 380,0 | 405,0 | 404,0 | 403,0 | 22 | | |
| 24 | 120,0 | 352,0 | 374,0 | 374,0 | - | 119,0 | 350,0 | 372,0 | 371,0 | 370,0 | 24 | | |
| 26 | 107,0 | 326,0 | 346,0 | 346,0 | - | 105,0 | 324,0 | 345,0 | 344,0 | 343,0 | 26 | | |
| 28 | 96,5 | 303,0 | 321,0 | 321,0 | - | 94,5 | 301,0 | 319,0 | 319,0 | 318,0 | 28 | | |
| 30 | 87,0 | 282,0 | 298,0 | 298,0 | - | 85,0 | 279,0 | 297,0 | 296,0 | 295,0 | 30 | | |
| 34 | 73,0 | 247,3 | 261,3 | 261,3 | - | 71,3 | 245,6 | 260,3 | 260,0 | 259,0 | 34 | | |
| 38 | 61,5 | 216,3 | 229,3 | 229,3 | - | 59,8 | 216,0 | 228,6 | 228,3 | 227,3 | 38 | | |
| 42 | 52,5 | 189,0 | 202,0 | 202,0 | - | 50,5 | 190,0 | 202,0 | 201,0 | 200,0 | 42 | | |
| 46 | 46,1 | 160,3 | 171,3 | 170,6 | - | 43,8 | 170,0 | 182,0 | 181,6 | 180,6 | 46 | | |
| 49 | 41,6 | 144,0 | 154,0 | 154,0 | - | 39,2 | 154,3 | 166,0 | 165,8 | 164,8 | 49 | | |
| 50 | - | - | - | - | - | 38,0 | 148,6 | 160,0 | 159,6 | 158,6 | 50 | | |
| 54 | - | - | - | - | - | 33,0 | 131,0 | 140,0 | 139,0 | 138,0 | 54 | | |



| 225 t + 50 t | | 11-19 m | | | | | 8,40 m | | 9.8 m/s | | 360° | | ISO |
|--------------|-------|---------|-------|-------------|-------|-------|--------|-------|---------|-------|-------------|-------|-------|
| | | 66 m | | | | | | | 72 m | | | | |
| | | SSL_1 | | SSL_2 | SSL_3 | SSL_4 | | | SSL_1 | | SSL_2 | SSL_3 | SSL_4 |
| | | 0 t | | 0 t - 325 t | | | | | 0 t | | 0 t - 325 t | | |
| m | t | t | t | t | t | t | t | t | t | t | t | t | m |
| 10 | 317,0 | 509,0 | 509,0 | 509,0 | 509,0 | 509,0 | 301,0 | 445,0 | 445,0 | 445,0 | 445,0 | 445,0 | 10 |
| 12 | 264,0 | 507,0 | 509,0 | 509,0 | 509,0 | 509,0 | 252,0 | 445,0 | 445,0 | 445,0 | 445,0 | 445,0 | 12 |
| 14 | 225,0 | 502,0 | 509,0 | 509,0 | 509,0 | 509,0 | 216,0 | 445,0 | 445,0 | 445,0 | 445,0 | 445,0 | 14 |
| 16 | 196,0 | 496,0 | 506,0 | 509,0 | 509,0 | 509,0 | 188,0 | 444,0 | 445,0 | 445,0 | 445,0 | 445,0 | 16 |
| 18 | 172,0 | 458,0 | 486,0 | 484,0 | 483,0 | 483,0 | 166,0 | 437,0 | 442,0 | 445,0 | 445,0 | 445,0 | 18 |
| 20 | 153,0 | 415,0 | 441,0 | 439,0 | 438,0 | 438,0 | 148,0 | 414,0 | 438,0 | 437,0 | 435,0 | 435,0 | 20 |
| 22 | 135,0 | 380,0 | 404,0 | 402,0 | 401,0 | 401,0 | 133,0 | 378,0 | 402,0 | 400,0 | 398,0 | 398,0 | 22 |
| 24 | 119,0 | 349,0 | 371,0 | 369,0 | 369,0 | 369,0 | 118,0 | 347,0 | 370,0 | 368,0 | 366,0 | 366,0 | 24 |
| 26 | 105,0 | 323,0 | 344,0 | 342,0 | 341,0 | 341,0 | 104,0 | 321,0 | 342,0 | 340,0 | 338,0 | 338,0 | 26 |
| 28 | 94,5 | 300,0 | 319,0 | 317,0 | 316,0 | 316,0 | 93,5 | 298,0 | 317,0 | 315,0 | 313,0 | 313,0 | 28 |
| 30 | 85,0 | 279,0 | 296,0 | 294,0 | 293,0 | 293,0 | 84,0 | 277,0 | 294,0 | 292,0 | 290,0 | 290,0 | 30 |
| 34 | 71,0 | 245,0 | 260,0 | 258,6 | 257,6 | 257,6 | 69,6 | 243,6 | 258,0 | 256,6 | 254,6 | 254,6 | 34 |
| 38 | 59,3 | 215,3 | 228,6 | 227,3 | 226,3 | 226,3 | 57,9 | 214,3 | 227,0 | 225,6 | 224,0 | 224,0 | 38 |
| 42 | 50,0 | 190,0 | 202,0 | 200,0 | 199,0 | 199,0 | 48,7 | 189,0 | 201,0 | 199,0 | 198,0 | 198,0 | 42 |
| 46 | 43,1 | 171,3 | 182,0 | 180,0 | 179,6 | 179,6 | 41,5 | 170,3 | 181,0 | 179,0 | 178,0 | 178,0 | 46 |
| 50 | 37,1 | 154,3 | 164,3 | 162,3 | 162,3 | 162,3 | 35,3 | 153,6 | 163,3 | 161,3 | 160,3 | 160,3 | 50 |
| 54 | 31,9 | 139,0 | 149,0 | 147,0 | 147,0 | 147,0 | 29,9 | 139,0 | 148,0 | 146,0 | 145,0 | 145,0 | 54 |
| 58 | 27,9 | 119,8 | 129,8 | 127,8 | 127,0 | 127,0 | 25,9 | 126,3 | 136,0 | 134,0 | 132,3 | 132,3 | 58 |
| 59 | 27,0 | 117,0 | 125,0 | 123,0 | 122,0 | 122,0 | 24,9 | 123,1 | 133,0 | 131,0 | 129,1 | 129,1 | 59 |
| 62 | - | - | - | - | - | - | 22,3 | 112,0 | 122,0 | 120,0 | 118,0 | 118,0 | 62 |
| 64 | - | - | - | - | - | - | 20,7 | 104,0 | 114,0 | 112,0 | 110,0 | 110,0 | 64 |

| 225 t + 50 t | | 11-19 m | | | | | 8,40 m | | 9.8 m/s | | 360° | | ISO |
|--------------|-------|---------|-------|-------------|-------|-------|--------|-------|---------|-------|-------------|-------|-------|
| | | 78 m | | | | | | | 84 m | | | | |
| | | SSL_1 | | SSL_2 | SSL_3 | SSL_4 | | | SSL_1 | | SSL_2 | SSL_3 | SSL_4 |
| | | 0 t | | 0 t - 325 t | | | | | 0 t | | 0 t - 325 t | | |
| m | t | t | t | t | t | t | t | t | t | t | t | t | m |
| 11 | 263,0 | 376,0 | 385,0 | 413,0 | 413,0 | 413,0 | 251,0 | 338,0 | 346,0 | 380,0 | 380,0 | 380,0 | 11 |
| 12 | 242,0 | 376,0 | 385,0 | 413,0 | 413,0 | 413,0 | 232,0 | 338,0 | 346,0 | 380,0 | 380,0 | 380,0 | 12 |
| 14 | 208,0 | 376,0 | 385,0 | 413,0 | 413,0 | 413,0 | 200,0 | 338,0 | 346,0 | 380,0 | 380,0 | 380,0 | 14 |
| 16 | 182,0 | 376,0 | 382,0 | 413,0 | 413,0 | 413,0 | 175,0 | 338,0 | 346,0 | 380,0 | 380,0 | 380,0 | 16 |
| 18 | 161,0 | 369,0 | 378,0 | 413,0 | 413,0 | 413,0 | 154,0 | 338,0 | 342,0 | 380,0 | 380,0 | 380,0 | 18 |
| 20 | 143,0 | 367,0 | 375,0 | 413,0 | 413,0 | 413,0 | 138,0 | 332,0 | 338,0 | 380,0 | 380,0 | 380,0 | 20 |
| 22 | 129,0 | 364,0 | 372,0 | 398,0 | 396,0 | 396,0 | 124,0 | 329,0 | 335,0 | 380,0 | 380,0 | 380,0 | 22 |
| 24 | 117,0 | 347,0 | 364,0 | 365,0 | 364,0 | 364,0 | 112,0 | 326,0 | 332,0 | 363,0 | 361,0 | 361,0 | 24 |
| 26 | 104,0 | 321,0 | 342,0 | 338,0 | 336,0 | 336,0 | 102,0 | 319,0 | 321,0 | 335,0 | 334,0 | 334,0 | 26 |
| 28 | 93,5 | 298,0 | 317,0 | 313,0 | 311,0 | 311,0 | 92,0 | 296,0 | 314,0 | 311,0 | 309,0 | 309,0 | 28 |
| 30 | 84,0 | 277,0 | 294,0 | 290,0 | 288,0 | 288,0 | 82,5 | 275,0 | 292,0 | 288,0 | 286,0 | 286,0 | 30 |
| 34 | 69,6 | 243,0 | 258,6 | 254,6 | 252,6 | 252,6 | 68,5 | 241,0 | 256,6 | 252,0 | 250,6 | 250,6 | 34 |
| 38 | 57,8 | 214,0 | 227,6 | 224,0 | 222,3 | 222,3 | 56,6 | 212,0 | 225,6 | 221,3 | 220,0 | 220,0 | 38 |
| 42 | 48,6 | 190,0 | 201,0 | 198,0 | 197,0 | 197,0 | 47,0 | 188,0 | 199,0 | 196,0 | 194,0 | 194,0 | 42 |
| 46 | 41,4 | 170,6 | 181,0 | 178,0 | 176,3 | 176,3 | 39,6 | 169,3 | 179,6 | 176,0 | 174,6 | 174,6 | 46 |
| 50 | 35,0 | 153,6 | 163,3 | 160,3 | 158,3 | 158,3 | 33,2 | 152,6 | 162,3 | 158,3 | 157,3 | 157,3 | 50 |
| 54 | 29,6 | 139,0 | 148,0 | 145,0 | 143,0 | 143,0 | 27,8 | 138,0 | 147,0 | 143,0 | 142,0 | 142,0 | 54 |
| 58 | 25,4 | 127,6 | 136,0 | 132,3 | 131,0 | 131,0 | 23,5 | 126,0 | 134,3 | 131,0 | 130,0 | 130,0 | 58 |
| 62 | 21,7 | 116,6 | 125,0 | 121,3 | 120,0 | 120,0 | 19,7 | 115,3 | 123,0 | 120,0 | 119,0 | 119,0 | 62 |
| 66 | 18,5 | 106,0 | 115,0 | 112,0 | 110,0 | 110,0 | 16,5 | 106,0 | 113,0 | 110,0 | 109,0 | 109,0 | 66 |
| 70 | 16,0 | 93,0 | 102,0 | 98,0 | 96,0 | 96,0 | 13,9 | 97,0 | 105,0 | 102,0 | 100,3 | 100,3 | 70 |
| 74 | - | - | - | - | - | - | 11,4 | 86,8 | 95,6 | 91,6 | 89,6 | 89,6 | 74 |
| 75 | - | - | - | - | - | - | 10,9 | 84,0 | 93,0 | 88,5 | 86,5 | 86,5 | 75 |

- 0t
- 65t
- 125t
- 165t
- 205t
- 245t
- 285t
- 325t

| 225 t + 50 t 11-19 m 8,40 m 9.8 m/s 360° ISO | | | | | | | | | | | | | | | |
|---|-------|----------|-------|-------|-------|-------|-------|----------|-------|-------|----|-------|---|-------|--|
| 90 m | | | | | | 96 m | | | | | | | | | |
| SSL_1 | | SSL_2 | | SSL_3 | | SSL_4 | | SSL_1 | | SSL_2 | | SSL_3 | | SSL_4 | |
| 0 t | | 0t- 325t | | | | 0 t | | 0t- 325t | | | | | | | |
| m | t | t | t | t | t | t | t | t | t | t | t | t | t | m | |
| 12 | 224,0 | 303,0 | 310,0 | 347,0 | 347,0 | 214,0 | 268,0 | 274,0 | 314,0 | 314,0 | 12 | | | | |
| 14 | 193,0 | 303,0 | 310,0 | 347,0 | 347,0 | 185,0 | 268,0 | 274,0 | 314,0 | 314,0 | 14 | | | | |
| 16 | 169,0 | 303,0 | 310,0 | 347,0 | 347,0 | 163,0 | 268,0 | 274,0 | 314,0 | 314,0 | 16 | | | | |
| 18 | 150,0 | 303,0 | 310,0 | 347,0 | 347,0 | 144,0 | 268,0 | 274,0 | 314,0 | 314,0 | 18 | | | | |
| 20 | 134,0 | 303,0 | 306,0 | 347,0 | 347,0 | 129,0 | 268,0 | 274,0 | 314,0 | 314,0 | 20 | | | | |
| 22 | 121,0 | 299,0 | 302,0 | 347,0 | 347,0 | 116,0 | 267,0 | 271,0 | 314,0 | 314,0 | 22 | | | | |
| 24 | 109,0 | 296,0 | 299,0 | 347,0 | 347,0 | 105,0 | 264,0 | 268,0 | 314,0 | 314,0 | 24 | | | | |
| 26 | 100,0 | 293,0 | 294,0 | 333,0 | 332,0 | 96,0 | 262,0 | 266,0 | 314,0 | 314,0 | 26 | | | | |
| 28 | 91,5 | 287,0 | 286,0 | 309,0 | 307,0 | 87,5 | 259,0 | 260,0 | 305,0 | 305,0 | 28 | | | | |
| 30 | 82,5 | 275,0 | 280,0 | 286,0 | 284,0 | 80,0 | 255,0 | 253,0 | 284,0 | 283,0 | 30 | | | | |
| 34 | 68,5 | 241,0 | 252,6 | 250,6 | 248,6 | 66,6 | 232,6 | 242,3 | 248,6 | 247,0 | 34 | | | | |
| 38 | 56,7 | 212,0 | 226,0 | 220,0 | 218,3 | 55,1 | 210,6 | 224,3 | 218,0 | 216,3 | 38 | | | | |
| 42 | 47,1 | 188,0 | 200,0 | 194,0 | 193,0 | 45,5 | 186,0 | 199,0 | 192,0 | 191,0 | 42 | | | | |
| 46 | 39,7 | 169,3 | 180,0 | 174,6 | 173,6 | 38,1 | 167,3 | 178,3 | 172,6 | 171,6 | 46 | | | | |
| 50 | 33,2 | 152,6 | 162,3 | 157,3 | 156,3 | 31,6 | 151,0 | 160,6 | 155,3 | 154,3 | 50 | | | | |
| 54 | 27,7 | 138,0 | 147,0 | 142,0 | 141,0 | 26,1 | 137,0 | 146,0 | 140,0 | 139,0 | 54 | | | | |
| 58 | 23,4 | 126,6 | 134,3 | 129,3 | 128,3 | 21,7 | 125,0 | 133,3 | 128,0 | 127,0 | 58 | | | | |
| 62 | 19,6 | 116,0 | 123,3 | 118,3 | 117,0 | 17,9 | 114,3 | 122,0 | 117,0 | 116,0 | 62 | | | | |
| 66 | 16,2 | 106,0 | 114,0 | 109,0 | 107,0 | 14,5 | 105,0 | 112,0 | 107,0 | 106,0 | 66 | | | | |
| 70 | 13,5 | 98,6 | 105,3 | 100,6 | 99,3 | 11,7 | 97,3 | 104,0 | 99,0 | 98,0 | 70 | | | | |
| 74 | 11,1 | 90,8 | 97,6 | 93,0 | 91,5 | 9,2 | 90,3 | 96,6 | 91,6 | 90,5 | 74 | | | | |
| 78 | 9,0 | 82,5 | 91,0 | 85,5 | 83,5 | 7,0 | 84,0 | 90,0 | 85,0 | 83,5 | 78 | | | | |
| 80 | 8,1 | 77,5 | 86,5 | 80,0 | 78,0 | 6,0 | 80,2 | 86,5 | 81,3 | 79,8 | 80 | | | | |
| 82 | - | - | - | - | - | 5,1 | 76,5 | 83,0 | 77,6 | 76,1 | 82 | | | | |
| 85 | - | - | - | - | - | - | 70,0 | 77,5 | 71,5 | 70,0 | 85 | | | | |

| 225 t + 50 t 11-19 m 8,40 m 9.8 m/s 360° ISO | | | | | | | | | | | | | | | |
|---|-------|----------|-------|-------|-------|-------|-------|----------|-------|-------|----|-------|---|-------|--|
| 102 m | | | | | | 108 m | | | | | | | | | |
| SSL_1 | | SSL_2 | | SSL_3 | | SSL_4 | | SSL_1 | | SSL_2 | | SSL_3 | | SSL_4 | |
| 0 t | | 0t- 325t | | | | 0 t | | 0t- 325t | | | | | | | |
| m | t | t | t | t | t | t | t | t | t | t | t | t | t | m | |
| 13 | 191,0 | 237,0 | 243,0 | 311,0 | 314,0 | 183,0 | 209,0 | 214,0 | 280,0 | 281,0 | 13 | | | | |
| 14 | 178,0 | 237,0 | 243,0 | 311,0 | 314,0 | 171,0 | 209,0 | 214,0 | 280,0 | 281,0 | 14 | | | | |
| 16 | 157,0 | 237,0 | 243,0 | 311,0 | 314,0 | 150,0 | 209,0 | 214,0 | 280,0 | 281,0 | 16 | | | | |
| 18 | 139,0 | 237,0 | 243,0 | 307,0 | 314,0 | 133,0 | 208,0 | 214,0 | 280,0 | 281,0 | 18 | | | | |
| 20 | 124,0 | 237,0 | 243,0 | 303,0 | 314,0 | 119,0 | 208,0 | 214,0 | 276,0 | 281,0 | 20 | | | | |
| 22 | 112,0 | 235,0 | 243,0 | 299,0 | 314,0 | 107,0 | 207,0 | 213,0 | 273,0 | 281,0 | 22 | | | | |
| 24 | 101,0 | 233,0 | 240,0 | 296,0 | 313,0 | 97,0 | 204,0 | 211,0 | 270,0 | 281,0 | 24 | | | | |
| 26 | 92,0 | 231,0 | 238,0 | 294,0 | 310,0 | 88,0 | 201,0 | 209,0 | 267,0 | 281,0 | 26 | | | | |
| 28 | 84,0 | 229,0 | 234,0 | 291,0 | 294,0 | 80,5 | 199,0 | 207,0 | 266,0 | 280,0 | 28 | | | | |
| 30 | 77,0 | 227,0 | 228,0 | 277,0 | 279,0 | 73,5 | 197,0 | 203,0 | 262,0 | 268,0 | 30 | | | | |
| 34 | 65,3 | 215,3 | 222,0 | 245,6 | 245,0 | 62,1 | 190,3 | 197,3 | 239,3 | 240,6 | 34 | | | | |
| 38 | 54,4 | 203,0 | 212,3 | 217,0 | 215,3 | 52,0 | 181,6 | 190,0 | 215,3 | 214,0 | 38 | | | | |
| 42 | 44,4 | 185,0 | 197,0 | 191,0 | 190,0 | 43,0 | 175,0 | 182,0 | 190,0 | 188,0 | 42 | | | | |
| 46 | 36,9 | 167,0 | 177,6 | 172,3 | 170,6 | 35,5 | 162,3 | 172,0 | 170,6 | 168,6 | 46 | | | | |
| 50 | 30,4 | 150,6 | 160,3 | 155,3 | 153,6 | 29,0 | 149,0 | 159,3 | 153,3 | 151,6 | 50 | | | | |
| 54 | 24,8 | 136,0 | 145,0 | 140,0 | 139,0 | 23,4 | 135,0 | 144,0 | 138,0 | 137,0 | 54 | | | | |
| 58 | 20,4 | 124,6 | 132,3 | 128,0 | 127,0 | 19,0 | 123,6 | 132,0 | 126,0 | 125,0 | 58 | | | | |
| 62 | 16,5 | 114,0 | 121,0 | 117,0 | 116,0 | 15,0 | 113,0 | 120,6 | 115,0 | 114,2 | 62 | | | | |
| 66 | 13,1 | 104,0 | 111,0 | 107,0 | 106,0 | 11,5 | 103,0 | 110,0 | 105,0 | 104,0 | 66 | | | | |
| 70 | 10,3 | 96,3 | 103,3 | 98,5 | 97,2 | 8,7 | 95,3 | 102,0 | 97,0 | 96,0 | 70 | | | | |
| 74 | 7,7 | 89,3 | 96,0 | 91,0 | 90,0 | 6,0 | 88,1 | 94,3 | 89,5 | 88,5 | 74 | | | | |
| 75 | 7,1 | 87,7 | 94,2 | 89,2 | 88,2 | 5,4 | 86,5 | 92,5 | 87,7 | 86,7 | 75 | | | | |
| 78 | 5,4 | 83,0 | 89,0 | 84,0 | 83,0 | - | 81,5 | 87,5 | 82,5 | 81,5 | 78 | | | | |
| 82 | - | 77,3 | 83,0 | 78,3 | 77,3 | - | 75,8 | 81,8 | 76,8 | 75,5 | 82 | | | | |
| 86 | - | 70,6 | 76,5 | 72,1 | 71,0 | - | 70,3 | 75,5 | 71,5 | 69,8 | 86 | | | | |
| 90 | - | 63,0 | 69,5 | 65,5 | 64,0 | - | 65,0 | 68,5 | 66,5 | 64,5 | 90 | | | | |
| 94 | - | - | - | - | - | - | 58,0 | 61,5 | 59,5 | 58,6 | 94 | | | | |
| 96 | - | - | - | - | - | - | 54,5 | 58,0 | 56,0 | 55,0 | 96 | | | | |

0t
 65t
 125t
 165t
 205t
 245t
 285t
 325t

| | | 165 t + 50 t | | 11-19 m | | 8,40 m | | 9.8 m/s | | 360° | | ISO | | | | | |
|----|-------|--------------|-------|-----------|-------|--------|-------|-----------|-------|-------|-------|-----------|-------|-------|---|-----------|----|
| | | 36 m | | 42 m | | 48 m | | 54 m | | 60 m | | 66 m | | 72 m | | | |
| | | SSL_1 | | | | | | | | | | | | | | | |
| | | 0 t | | 0 t-325 t | | 0 t | | 0 t-325 t | | 0 t | | 0 t-325 t | | 0 t | | 0 t-325 t | |
| m | t | t | t | t | t | t | t | t | t | t | t | t | t | t | t | t | m |
| 7 | 533,0 | 650,0 | 490,0 | 650,0 | - | - | - | - | - | - | - | - | - | - | - | - | 7 |
| 8 | 451,0 | 650,0 | 419,0 | 650,0 | 390,0 | 650,0 | 366,0 | 650,0 | - | - | - | - | - | - | - | - | 8 |
| 9 | 390,0 | 650,0 | 365,0 | 650,0 | 343,0 | 650,0 | 323,0 | 650,0 | 304,0 | 571,0 | - | - | - | - | - | - | 9 |
| 10 | 343,0 | 650,0 | 323,0 | 650,0 | 305,0 | 650,0 | 289,0 | 650,0 | 273,0 | 571,0 | 260,0 | 509,0 | 246,0 | 445,0 | - | - | 10 |
| 12 | 276,0 | 650,0 | 262,0 | 650,0 | 249,0 | 647,0 | 237,0 | 645,0 | 226,0 | 571,0 | 216,0 | 507,0 | 206,0 | 445,0 | - | - | 12 |
| 14 | 227,0 | 574,0 | 219,0 | 571,0 | 209,0 | 568,0 | 200,0 | 566,0 | 191,0 | 563,0 | 183,0 | 499,0 | 175,0 | 445,0 | - | - | 14 |
| 16 | 185,0 | 511,0 | 183,0 | 509,0 | 179,0 | 506,0 | 172,0 | 503,0 | 165,0 | 501,0 | 159,0 | 496,0 | 152,0 | 441,0 | - | - | 16 |
| 18 | 155,0 | 460,0 | 153,0 | 458,0 | 152,0 | 455,0 | 150,0 | 453,0 | 144,0 | 450,0 | 139,0 | 450,0 | 133,0 | 437,0 | - | - | 18 |
| 20 | 132,0 | 419,0 | 131,0 | 416,0 | 129,0 | 413,0 | 128,0 | 411,0 | 126,0 | 408,0 | 123,0 | 408,0 | 118,0 | 406,0 | - | - | 20 |
| 22 | 115,0 | 383,0 | 114,0 | 381,0 | 112,0 | 378,0 | 110,0 | 376,0 | 109,0 | 373,0 | 109,0 | 373,0 | 106,0 | 371,0 | - | - | 22 |
| 24 | 102,0 | 344,0 | 100,0 | 351,0 | 98,5 | 348,0 | 97,0 | 346,0 | 95,0 | 343,0 | 95,0 | 343,0 | 94,0 | 341,0 | - | - | 24 |
| 26 | 91,0 | 306,0 | 89,0 | 323,0 | 87,5 | 321,0 | 85,5 | 318,0 | 84,0 | 316,0 | 84,0 | 315,0 | 83,0 | 314,0 | - | - | 26 |
| 28 | 82,0 | 278,0 | 80,0 | 299,0 | 78,0 | 297,0 | 76,5 | 294,0 | 74,5 | 292,0 | 74,5 | 291,0 | 73,5 | 290,0 | - | - | 28 |
| 30 | 74,0 | 247,0 | 72,5 | 275,0 | 70,5 | 276,0 | 68,5 | 273,0 | 67,0 | 271,0 | 66,5 | 270,0 | 65,5 | 269,0 | - | - | 30 |
| 33 | 65,0 | 211,0 | 64,0 | 237,5 | 61,7 | 251,0 | 60,0 | 248,5 | 58,3 | 246,5 | 57,9 | 245,5 | 56,8 | 244,0 | - | - | 33 |
| 34 | - | - | 61,1 | 225,0 | 58,8 | 242,6 | 57,1 | 240,3 | 55,4 | 238,3 | 55,0 | 237,3 | 53,9 | 235,6 | - | - | 34 |
| 38 | - | - | 51,0 | 186,0 | 49,3 | 207,3 | 47,6 | 211,6 | 45,6 | 209,6 | 45,2 | 208,6 | 43,9 | 207,0 | - | - | 38 |
| 42 | - | - | - | - | 42,1 | 175,0 | 40,0 | 187,0 | 37,7 | 185,0 | 37,1 | 184,0 | 35,5 | 183,0 | - | - | 42 |
| 44 | - | - | - | - | 39,2 | 159,0 | 37,2 | 173,3 | 34,8 | 175,3 | 34,1 | 174,6 | 32,5 | 173,3 | - | - | 44 |
| 46 | - | - | - | - | - | - | 34,4 | 159,6 | 31,9 | 165,6 | 31,2 | 165,3 | 29,5 | 163,6 | - | - | 46 |
| 49 | - | - | - | - | - | - | 30,6 | 143,0 | 28,0 | 151,0 | 27,2 | 152,3 | 25,4 | 150,3 | - | - | 49 |
| 50 | - | - | - | - | - | - | - | - | 27,0 | 146,0 | 26,1 | 148,6 | 24,3 | 146,6 | - | - | 50 |
| 54 | - | - | - | - | - | - | - | - | 23,0 | 126,0 | 21,8 | 134,0 | 19,9 | 132,0 | - | - | 54 |
| 58 | - | - | - | - | - | - | - | - | - | - | 18,6 | 118,8 | 16,5 | 121,3 | - | - | 58 |
| 59 | - | - | - | - | - | - | - | - | - | - | 17,8 | 115,0 | 15,7 | 118,6 | - | - | 59 |
| 62 | - | - | - | - | - | - | - | - | - | - | - | - | 13,6 | 110,0 | - | - | 62 |
| 64 | - | - | - | - | - | - | - | - | - | - | - | - | 12,3 | 104,0 | - | - | 64 |

| | | | | | | | |
|---|-----|-------|-------|-------|-------|-------|-------|
|  | 0 t | 125 t | 165 t | 205 t | 245 t | 285 t | 325 t |
|---|-----|-------|-------|-------|-------|-------|-------|

| 165 t + 50 t | | 11-19 m | | 8,40 m | | 9.8 m/s | | 360° | | ISO | | | |
|--------------|-------|---------|-------|---------|-------|---------|-------|---------|-------|---------|-------|---------|----|
| 78 m | | 84 m | | 90 m | | 96 m | | 102 m | | 108 m | | | |
| SSL_1 | | | | | | | | | | | | | |
| | 0 t | 0t-325t | 0 t | 0t-325t | 0 t | 0t-325t | 0 t | 0t-325t | 0 t | 0t-325t | 0 t | 0t-325t | |
| m | t | t | t | t | t | t | t | t | t | t | t | t | m |
| 11 | 215,0 | 376,0 | 205,0 | 338,0 | - | - | - | - | - | - | - | - | 11 |
| 12 | 197,0 | 376,0 | 188,0 | 338,0 | 181,0 | 303,0 | 173,0 | 268,0 | - | - | - | - | 12 |
| 13 | 183,0 | 376,0 | 174,5 | 338,0 | 168,5 | 303,0 | 161,0 | 268,0 | 154,0 | 237,0 | 147,0 | 209,0 | 13 |
| 14 | 169,0 | 376,0 | 161,0 | 338,0 | 156,0 | 303,0 | 149,0 | 268,0 | 143,0 | 237,0 | 137,0 | 209,0 | 14 |
| 16 | 147,0 | 372,0 | 140,0 | 338,0 | 136,0 | 303,0 | 130,0 | 268,0 | 125,0 | 237,0 | 119,0 | 209,0 | 16 |
| 18 | 129,0 | 369,0 | 124,0 | 334,0 | 120,0 | 303,0 | 115,0 | 268,0 | 110,0 | 237,0 | 105,0 | 208,0 | 18 |
| 20 | 114,0 | 367,0 | 110,0 | 331,0 | 107,0 | 299,0 | 102,0 | 268,0 | 98,0 | 237,0 | 93,5 | 208,0 | 20 |
| 22 | 102,0 | 364,0 | 98,0 | 329,0 | 95,5 | 296,0 | 91,5 | 267,0 | 87,5 | 235,0 | 83,5 | 207,0 | 22 |
| 24 | 92,5 | 341,0 | 88,5 | 326,0 | 86,0 | 294,0 | 82,0 | 264,0 | 78,5 | 233,0 | 75,0 | 204,0 | 24 |
| 26 | 83,0 | 314,0 | 80,0 | 312,0 | 78,0 | 292,0 | 74,5 | 262,0 | 71,0 | 230,0 | 67,5 | 201,0 | 26 |
| 28 | 73,5 | 289,0 | 72,0 | 287,0 | 71,0 | 287,0 | 71,0 | 259,0 | 64,0 | 228,0 | 60,5 | 199,0 | 28 |
| 30 | 65,5 | 268,0 | 64,5 | 266,0 | 64,5 | 266,0 | 61,0 | 252,0 | 58,0 | 227,0 | 55,0 | 197,0 | 30 |
| 34 | 53,9 | 235,3 | 52,5 | 233,3 | 52,5 | 233,3 | 50,4 | 227,3 | 48,6 | 215,3 | 45,8 | 189,3 | 34 |
| 38 | 43,8 | 207,0 | 42,2 | 205,0 | 42,3 | 205,0 | 40,9 | 203,3 | 39,7 | 201,0 | 37,4 | 181,6 | 38 |
| 42 | 35,4 | 183,0 | 33,7 | 181,0 | 33,8 | 181,0 | 32,3 | 180,0 | 31,1 | 179,0 | 29,8 | 175,0 | 42 |
| 46 | 29,3 | 163,6 | 27,6 | 161,6 | 27,6 | 161,6 | 26,1 | 160,6 | 24,9 | 159,6 | 23,5 | 157,6 | 46 |
| 50 | 24,0 | 146,6 | 22,3 | 145,0 | 22,3 | 145,0 | 20,6 | 143,6 | 19,4 | 142,6 | 18,0 | 141,6 | 50 |
| 54 | 19,6 | 132,0 | 17,7 | 131,0 | 17,7 | 131,0 | 16,0 | 129,0 | 14,8 | 128,0 | 13,3 | 127,0 | 54 |
| 58 | 16,1 | 120,6 | 14,2 | 119,6 | 14,1 | 119,0 | 12,4 | 117,6 | 11,1 | 116,6 | 9,6 | 115,6 | 58 |
| 62 | 13,0 | 110,6 | 11,1 | 109,3 | 10,9 | 108,6 | 9,2 | 107,5 | 7,8 | 106,4 | 6,2 | 104,6 | 62 |
| 63 | 12,4 | 108,5 | 10,4 | 107,0 | 10,2 | 106,5 | 8,5 | 105,2 | 7,0 | 104,1 | 5,5 | 102,0 | 63 |
| 65 | 11,0 | 104,1 | 9,0 | 102,3 | 8,8 | 102,1 | 7,1 | 100,7 | 5,6 | 99,5 | - | 98,0 | 65 |
| 66 | 10,4 | 102,0 | 8,4 | 100,0 | 8,1 | 100,0 | 6,4 | 98,5 | - | 97,5 | - | 96,0 | 66 |
| 68 | 9,4 | 97,5 | 7,3 | 96,5 | 6,9 | 96,2 | 5,1 | 94,5 | - | 93,6 | - | 92,3 | 68 |
| 70 | 8,4 | 93,0 | 6,2 | 93,0 | 5,8 | 92,4 | - | 91,0 | - | 89,8 | - | 88,6 | 70 |
| 71 | - | - | 5,7 | 91,2 | 5,3 | 90,5 | - | 89,2 | - | 87,9 | - | 86,8 | 71 |
| 72 | - | - | 5,2 | 89,5 | - | 89,0 | - | 87,5 | - | 86,0 | - | 85,0 | 72 |
| 74 | - | - | - | 85,8 | - | 86,0 | - | 84,3 | - | 83,0 | - | 81,8 | 74 |
| 75 | - | - | - | 84,0 | - | 84,5 | - | 82,7 | - | 81,5 | - | 80,2 | 75 |
| 78 | - | - | - | - | - | 80,0 | - | 78,0 | - | 77,0 | - | 75,5 | 78 |
| 80 | - | - | - | - | - | 77,0 | - | 75,5 | - | 74,3 | - | 72,8 | 80 |
| 82 | - | - | - | - | - | - | - | 73,0 | - | 71,6 | - | 70,1 | 82 |
| 85 | - | - | - | - | - | - | - | 69,0 | - | 67,9 | - | 66,3 | 85 |
| 86 | - | - | - | - | - | - | - | - | - | 66,8 | - | 65,1 | 86 |
| 90 | - | - | - | - | - | - | - | - | - | 62,5 | - | 60,5 | 90 |
| 94 | - | - | - | - | - | - | - | - | - | - | - | 56,5 | 94 |
| 96 | - | - | - | - | - | - | - | - | - | - | - | 54,5 | 96 |



| 165 t + 50 t | | 11-19 m | | 8,40 m | | 9.8 m/s | | 360° | | ISO | | | | |
|--------------|-------|---------|-------|---------|-------|---------|-------|---------|-------|---------|-------|---------|-------|----|
| 54 m | | 60 m | | 66 m | | 72 m | | 78 m | | 84 m | | 90 m | | |
| LSL_2 | | LSL_2 | | LSL_1 | | LSL_2 | | LSL_1 | | LSL_2 | | LSL_1 | | |
| 0 t | | 0t-325t | | 0t | | 0t-325t | | 0 t | | 0t-325t | | 0 t | | |
| 0t-325t | | 0t-325t | | 0t-325t | | 0t-325t | | 0t-325t | | 0t-325t | | 0t-325t | | |
| m | t | t | t | t | t | t | t | t | t | t | t | t | t | m |
| 8 | 347,0 | 347,0 | - | - | - | - | - | - | - | - | - | - | - | 8 |
| 9 | 320,0 | 347,0 | 302,0 | 347,0 | 286,0 | 347,0 | - | - | - | - | - | - | - | 9 |
| 10 | 287,0 | 347,0 | 272,0 | 347,0 | 258,0 | 347,0 | 252,0 | 347,0 | 347,0 | 240,0 | 325,0 | 331,0 | - | 10 |
| 11 | 261,5 | 347,0 | 248,5 | 347,0 | 236,5 | 347,0 | 232,0 | 347,0 | 347,0 | 221,0 | 325,0 | 331,0 | 211,0 | 11 |
| 12 | 236,0 | 347,0 | 225,0 | 347,0 | 215,0 | 347,0 | 212,0 | 347,0 | 347,0 | 202,0 | 325,0 | 331,0 | 195,0 | 12 |
| 14 | 200,0 | 347,0 | 191,0 | 347,0 | 183,0 | 347,0 | 182,0 | 347,0 | 347,0 | 174,0 | 325,0 | 331,0 | 169,0 | 14 |
| 16 | 173,0 | 347,0 | 166,0 | 347,0 | 159,0 | 347,0 | 158,0 | 347,0 | 347,0 | 152,0 | 323,0 | 328,0 | 148,0 | 16 |
| 18 | 151,0 | 347,0 | 146,0 | 347,0 | 140,0 | 347,0 | 140,0 | 347,0 | 347,0 | 134,0 | 322,0 | 328,0 | 131,0 | 18 |
| 20 | 131,0 | 347,0 | 129,0 | 347,0 | 124,0 | 347,0 | 125,0 | 347,0 | 347,0 | 120,0 | 322,0 | 328,0 | 117,0 | 20 |
| 22 | 114,0 | 347,0 | 113,0 | 347,0 | 111,0 | 347,0 | 112,0 | 337,0 | 343,0 | 108,0 | 321,0 | 325,0 | 106,0 | 22 |
| 24 | 100,0 | 347,0 | 99,5 | 347,0 | 97,5 | 346,0 | 101,0 | 326,0 | 332,0 | 98,0 | 308,0 | 313,0 | 96,0 | 24 |
| 26 | 89,5 | 323,0 | 88,0 | 321,0 | 86,5 | 319,0 | 89,5 | 316,0 | 319,0 | 88,0 | 296,0 | 300,0 | 87,5 | 26 |
| 28 | 80,5 | 299,0 | 79,0 | 297,0 | 77,5 | 295,0 | 80,5 | 298,0 | 295,0 | 78,5 | 284,0 | 288,0 | 79,5 | 28 |
| 30 | 72,5 | 278,0 | 71,5 | 276,0 | 69,5 | 274,0 | 72,5 | 277,0 | 274,0 | 70,5 | 273,0 | 272,0 | 71,5 | 30 |
| 34 | 61,1 | 245,3 | 59,8 | 243,3 | 57,8 | 241,3 | 60,5 | 244,3 | 241,3 | 58,8 | 241,0 | 239,3 | 59,5 | 34 |
| 38 | 51,7 | 216,3 | 50,1 | 214,3 | 48,2 | 212,3 | 50,6 | 215,0 | 212,6 | 49,0 | 212,6 | 210,6 | 49,6 | 38 |
| 42 | 44,1 | 191,0 | 42,5 | 189,0 | 40,6 | 187,0 | 42,9 | 189,0 | 188,0 | 41,2 | 188,0 | 186,0 | 41,9 | 42 |
| 46 | 38,6 | 165,6 | 36,9 | 170,3 | 34,8 | 168,3 | 37,1 | 170,3 | 168,6 | 35,2 | 168,6 | 167,3 | 35,9 | 46 |
| 49 | 34,8 | 147,0 | 33,1 | 156,3 | 30,9 | 155,3 | 33,1 | 157,3 | 155,5 | 31,0 | 155,3 | 154,3 | 31,7 | 49 |
| 50 | - | - | 32,1 | 151,6 | 29,8 | 151,6 | 32,0 | 153,6 | 152,0 | 29,9 | 151,6 | 150,6 | 30,6 | 50 |
| 54 | - | - | 27,9 | 133,0 | 25,5 | 137,0 | 27,6 | 139,0 | 138,0 | 25,4 | 137,0 | 136,0 | 26,0 | 54 |
| 58 | - | - | - | - | 22,1 | 123,4 | 24,2 | 127,6 | 126,6 | 21,9 | 125,6 | 124,6 | 22,4 | 58 |
| 59 | - | - | - | - | 21,3 | 120,0 | 23,3 | 124,8 | 123,8 | 21,0 | 122,8 | 121,8 | 21,5 | 59 |
| 62 | - | - | - | - | - | - | 21,1 | 117,5 | 116,5 | 18,8 | 115,6 | 114,6 | 19,3 | 62 |
| 64 | - | - | - | - | - | - | 19,8 | 113,0 | 112,0 | 17,5 | 111,3 | 110,3 | 17,9 | 64 |
| 66 | - | - | - | - | - | - | - | - | - | 16,2 | 107,0 | 106,0 | 16,5 | 66 |
| 69 | - | - | - | - | - | - | - | - | - | 14,6 | 99,5 | 99,0 | 14,9 | 69 |
| 70 | - | - | - | - | - | - | - | - | - | - | - | - | 14,3 | 70 |
| 74 | - | - | - | - | - | - | - | - | - | - | - | - | 12,3 | 74 |
| 75 | - | - | - | - | - | - | - | - | - | - | - | - | 11,9 | 75 |
| 78 | - | - | - | - | - | - | - | - | - | - | - | - | - | 78 |
| 80 | - | - | - | - | - | - | - | - | - | - | - | - | - | 80 |



| 165 t + 50 t | | 11-19 m | | 8,40 m | | 9.8 m/s | | 360° | | ISO | | | | | | | |
|---------------|-------|-----------|-------|---------------|-------|------------------------|-------|-------|-------|----------------|-------|-------|-------|-------|-------|-------|----|
| 96 m | | 99 m | | 102 m | | 105 m | | | | | | | | | | | |
| LSL_1 LSL_2 | | LSL_7 | | LSL_1 LSL_2 | | LSL_7 LSL_9 LSL_11 | | LSL_7 | | LSL_9 LSL_11 | | | | | | | |
| 0 t | | 0 t-325 t | | 0 t | | 0 t-325 t | | 0 t | | 0 t-325 t | | | | | | | |
| m | t | t | t | t | t | t | t | t | t | t | t | t | t | t | t | m | |
| 12 | 179,0 | 216,0 | 242,0 | 266,0 | 166,0 | 253,0 | 172,0 | 196,0 | 218,0 | 239,0 | 267,0 | 274,0 | - | - | - | - | 12 |
| 13 | 167,5 | 215,0 | 241,0 | 266,0 | 154,5 | 253,0 | 160,5 | 196,0 | 217,0 | 239,0 | 267,0 | 272,0 | 137,0 | 227,0 | 255,0 | 262,0 | 13 |
| 14 | 156,0 | 214,0 | 240,0 | 266,0 | 143,0 | 253,0 | 149,0 | 196,0 | 216,0 | 239,0 | 267,0 | 270,0 | 137,0 | 227,0 | 255,0 | 261,0 | 14 |
| 16 | 137,0 | 212,0 | 240,0 | 266,0 | 125,0 | 253,0 | 131,0 | 196,0 | 216,0 | 239,0 | 267,0 | 271,0 | 119,0 | 227,0 | 255,0 | 260,0 | 16 |
| 18 | 121,0 | 208,0 | 240,0 | 266,0 | 110,0 | 253,0 | 117,0 | 196,0 | 216,0 | 239,0 | 265,0 | 269,0 | 105,0 | 227,0 | 253,0 | 258,0 | 18 |
| 20 | 109,0 | 204,0 | 240,0 | 264,0 | 98,0 | 252,0 | 104,0 | 195,0 | 216,0 | 239,0 | 264,0 | 266,0 | 93,5 | 227,0 | 251,0 | 256,0 | 20 |
| 22 | 98,5 | 200,0 | 240,0 | 260,0 | 87,5 | 247,0 | 94,5 | 194,0 | 216,0 | 239,0 | 263,0 | 264,0 | 83,5 | 223,0 | 251,0 | 254,0 | 22 |
| 24 | 89,0 | 196,0 | 240,0 | 259,0 | 78,5 | 245,0 | 85,5 | 194,0 | 215,0 | 230,0 | 258,0 | 260,0 | 75,0 | 217,0 | 246,0 | 252,0 | 24 |
| 26 | 81,0 | 192,0 | 240,0 | 259,0 | 71,0 | 244,0 | 78,0 | 193,0 | 215,0 | 229,0 | 255,0 | 257,0 | 67,5 | 216,0 | 242,0 | 249,0 | 26 |
| 28 | 74,5 | 185,0 | 234,0 | 258,0 | 64,0 | 244,0 | 71,0 | 192,0 | 215,0 | 228,0 | 251,0 | 252,0 | 61,0 | 214,0 | 239,0 | 245,0 | 28 |
| 30 | 68,5 | 179,0 | 231,0 | 248,0 | 58,5 | 237,0 | 65,0 | 190,0 | 214,0 | 224,0 | 243,0 | 245,0 | 55,0 | 212,0 | 231,0 | 238,0 | 30 |
| 34 | 57,1 | 165,6 | 215,3 | 226,6 | 48,9 | 221,6 | 55,3 | 181,6 | 208,3 | 209,0 | 226,3 | 230,3 | 45,9 | 197,6 | 215,0 | 222,0 | 34 |
| 38 | 47,5 | 152,3 | 203,3 | 204,0 | 39,9 | 202,3 | 46,5 | 170,3 | 198,6 | 194,0 | 210,0 | 213,0 | 37,4 | 184,3 | 199,3 | 206,3 | 38 |
| 42 | 39,7 | 139,0 | 184,0 | 180,0 | 31,4 | 179,0 | 38,5 | 165,0 | 182,0 | 178,0 | 194,0 | 193,0 | 29,4 | 171,0 | 184,0 | 191,0 | 42 |
| 46 | 33,5 | 127,6 | 164,6 | 160,6 | 25,2 | 159,6 | 32,2 | 157,3 | 162,6 | 159,3 | 174,0 | 173,0 | 23,2 | 156,3 | 170,0 | 171,6 | 46 |
| 50 | 28,0 | 117,0 | 147,6 | 143,6 | 19,9 | 143,0 | 26,7 | 148,0 | 146,0 | 142,6 | 156,0 | 155,3 | 17,9 | 141,6 | 155,0 | 154,3 | 50 |
| 54 | 23,4 | 107,0 | 133,0 | 129,0 | 15,3 | 129,0 | 22,1 | 134,0 | 132,0 | 128,0 | 140,0 | 140,0 | 13,3 | 127,0 | 139,0 | 139,0 | 54 |
| 58 | 19,8 | 98,6 | 121,6 | 117,6 | 11,7 | 117,0 | 18,4 | 122,6 | 120,0 | 116,6 | 128,0 | 127,3 | 9,7 | 115,6 | 127,0 | 126,3 | 58 |
| 62 | 16,5 | 90,3 | 111,6 | 107,6 | 8,5 | 106,6 | 15,1 | 112,3 | 109,6 | 106,3 | 117,3 | 116,3 | 6,4 | 105,4 | 116,3 | 115,3 | 62 |
| 65 | 14,4 | 84,4 | 105,1 | 101,1 | 6,4 | 100,1 | 13,0 | 105,3 | 103,1 | 99,3 | 110,3 | 109,3 | 4,2 | 98,5 | 109,3 | 108,3 | 65 |
| 66 | 13,7 | 82,5 | 103,0 | 99,0 | 5,7 | 98,0 | 12,3 | 103,0 | 101,0 | 97,0 | 108,0 | 107,0 | - | 96,0 | 107,0 | 106,0 | 66 |
| 68 | 12,5 | 79,0 | 99,1 | 95,2 | 4,5 | 94,0 | 11,1 | 99,5 | 97,3 | 93,2 | 104,0 | 102,7 | - | 92,3 | 102,7 | 101,0 | 68 |
| 70 | 11,3 | 75,5 | 95,3 | 91,5 | - | 90,5 | 9,9 | 96,0 | 93,6 | 89,6 | 100,0 | 98,5 | - | 88,6 | 98,5 | 97,5 | 70 |
| 74 | 9,2 | 68,8 | 88,5 | 84,8 | - | 83,8 | 7,7 | 89,3 | 86,6 | 82,8 | 92,6 | 91,6 | - | 81,8 | 91,5 | 90,6 | 74 |
| 78 | 7,4 | 63,5 | 82,5 | 78,5 | - | 77,5 | 5,9 | 83,0 | 80,5 | 76,5 | 86,0 | 85,0 | - | 75,5 | 84,5 | 84,0 | 78 |
| 82 | 5,9 | 57,8 | 77,1 | 73,1 | - | 72,1 | 4,2 | 77,5 | 75,1 | 71,5 | 80,3 | 79,3 | - | 68,1 | 77,8 | 78,3 | 82 |
| 85 | 4,9 | 54,0 | 73,5 | 69,5 | - | 68,3 | - | 73,9 | 71,4 | 67,2 | 76,0 | 75,3 | - | 62,6 | 72,5 | 73,8 | 85 |
| 86 | - | - | - | - | - | 67,2 | - | 72,8 | 70,3 | 65,5 | 74,5 | 74,1 | - | 60,8 | 70,6 | 72,1 | 86 |
| 88 | - | - | - | - | - | 65,0 | - | 70,6 | 68,1 | 62,0 | 71,5 | 71,8 | - | 57,1 | 66,8 | 68,8 | 88 |
| 90 | - | - | - | - | - | - | - | 68,5 | 66,0 | 58,5 | 68,5 | 69,5 | - | 55,0 | 63,5 | 65,5 | 90 |
| 93 | - | - | - | - | - | - | - | - | - | - | - | - | - | 50,0 | 59,5 | 59,5 | 93 |

0t
65t
125t
165t
205t
245t
285t
325t

| 108 m | | | | | | | | | | | 111 m | | | | |
|-------|-------|-------|-------|---|-------|-------|-------|---|---|---|-------|-------|-------|---|----|
| | | | | | | | | | | | | | | | |
| | | | | | | | | | | | | | | | |
| m | t | t | t | t | t | t | t | t | t | t | t | t | t | t | m |
| 13 | 153,0 | 177,0 | 195,0 | - | 217,0 | 242,0 | 251,0 | - | - | - | 207,0 | 231,0 | 240,0 | - | 13 |
| 14 | 143,0 | 177,0 | 195,0 | - | 217,0 | 242,0 | 251,0 | - | - | - | 207,0 | 231,0 | 240,0 | - | 14 |
| 16 | 125,0 | 177,0 | 195,0 | - | 217,0 | 242,0 | 249,0 | - | - | - | 207,0 | 231,0 | 239,0 | - | 16 |
| 18 | 111,0 | 177,0 | 195,0 | - | 217,0 | 242,0 | 248,0 | - | - | - | 205,0 | 231,0 | 238,0 | - | 18 |
| 20 | 100,0 | 176,0 | 195,0 | - | 216,0 | 242,0 | 245,0 | - | - | - | 203,0 | 231,0 | 236,0 | - | 20 |
| 22 | 90,0 | 176,0 | 195,0 | - | 214,0 | 242,0 | 244,0 | - | - | - | 201,0 | 231,0 | 234,0 | - | 22 |
| 24 | 81,5 | 175,0 | 195,0 | - | 208,0 | 240,0 | 243,0 | - | - | - | 197,0 | 229,0 | 233,0 | - | 24 |
| 26 | 74,0 | 175,0 | 194,0 | - | 205,0 | 238,0 | 239,0 | - | - | - | 194,0 | 227,0 | 228,0 | - | 26 |
| 28 | 67,5 | 174,0 | 194,0 | - | 203,0 | 236,0 | 236,0 | - | - | - | 191,0 | 227,0 | 224,0 | - | 28 |
| 30 | 61,5 | 174,0 | 194,0 | - | 201,0 | 235,0 | 230,0 | - | - | - | 189,0 | 225,0 | 219,0 | - | 30 |
| 34 | 52,4 | 170,0 | 191,3 | - | 188,3 | 220,0 | 214,0 | - | - | - | 177,6 | 213,0 | 203,0 | - | 34 |
| 38 | 44,2 | 163,0 | 184,3 | - | 175,3 | 207,0 | 198,3 | - | - | - | 165,6 | 201,3 | 187,6 | - | 38 |
| 42 | 36,9 | 158,0 | 181,0 | - | 162,0 | 191,0 | 183,0 | - | - | - | 153,0 | 190,0 | 173,0 | - | 42 |
| 46 | 30,6 | 151,0 | 161,6 | - | 150,0 | 171,6 | 168,3 | - | - | - | 141,0 | 170,6 | 159,6 | - | 46 |
| 50 | 25,1 | 143,6 | 144,6 | - | 138,3 | 154,0 | 153,3 | - | - | - | 129,6 | 153,0 | 146,6 | - | 50 |
| 54 | 20,4 | 133,0 | 130,0 | - | 127,0 | 138,0 | 138,0 | - | - | - | 119,0 | 137,0 | 134,0 | - | 54 |
| 58 | 16,7 | 121,6 | 118,6 | - | 115,0 | 126,0 | 126,0 | - | - | - | 109,0 | 125,0 | 123,3 | - | 58 |
| 62 | 13,4 | 111,3 | 108,5 | - | 104,5 | 115,3 | 115,0 | - | - | - | 99,6 | 114,0 | 113,2 | - | 62 |
| 66 | 10,5 | 102,0 | 99,5 | - | 96,0 | 106,0 | 105,0 | - | - | - | 91,0 | 104,0 | 103,0 | - | 66 |
| 70 | 8,1 | 94,6 | 91,9 | - | 88,3 | 97,2 | 97,0 | - | - | - | 82,6 | 96,3 | 94,6 | - | 70 |
| 74 | 5,9 | 87,8 | 85,0 | - | 80,5 | 90,1 | 89,6 | - | - | - | 74,6 | 89,1 | 86,5 | - | 74 |
| 77 | 4,4 | 83,0 | 80,5 | - | 74,5 | 85,1 | 84,6 | - | - | - | 68,9 | 84,1 | 80,5 | - | 77 |
| 78 | - | 81,5 | 79,0 | - | 72,5 | 83,5 | 83,0 | - | - | - | 67,0 | 82,5 | 78,5 | - | 78 |
| 82 | - | 76,1 | 73,6 | - | 64,8 | 77,8 | 76,6 | - | - | - | 60,0 | 76,8 | 70,8 | - | 82 |
| 86 | - | 71,1 | 68,6 | - | 57,8 | 72,6 | 69,6 | - | - | - | 53,2 | 71,6 | 64,1 | - | 86 |
| 90 | - | 66,5 | 64,0 | - | 51,5 | 68,0 | 62,0 | - | - | - | 46,8 | 67,0 | 57,5 | - | 90 |
| 94 | - | 62,5 | 60,4 | - | 45,0 | 64,0 | 55,9 | - | - | - | 41,0 | 62,6 | 50,6 | - | 94 |
| 95 | - | 61,5 | 59,5 | - | 43,4 | 63,0 | 54,5 | - | - | - | 39,7 | 61,5 | 49,7 | - | 95 |
| 98 | - | - | - | - | - | - | - | - | - | - | 35,4 | 59,0 | 45,6 | - | 98 |

| | | | | | | | |
|--|------|-------|-------|-------|-------|-------|-------|
| | 65 t | 125 t | 165 t | 205 t | 245 t | 285 t | 325 t |
|--|------|-------|-------|-------|-------|-------|-------|

| 165 t + 50 t | | 11-19 m | | 8,40 m | | 9.8 m/s | | 360° | | ISO | | | | | |
|--------------|-------|---------|-------|--------|-------|---------|-------|-------|-------|--------|-------|---------|-------|---|-----|
| 114 m | | | | | | | | | | | 117 m | | | | |
| LSL_1 | | LSL_2 | | LSL_5 | | LSL_7 | | LSL_9 | | LSL_11 | | LSL_13 | | | |
| 0 t | | 0t-325t | | | | | | | | 0 t | | 0t-325t | | | |
| m | t | t | t | t | t | t | t | t | t | t | t | t | t | t | m |
| 13 | 146,0 | 162,0 | 176,0 | 185,0 | 195,0 | 219,0 | 230,0 | - | - | - | - | - | - | - | 13 |
| 14 | 137,0 | 162,0 | 175,0 | 185,0 | 195,0 | 219,0 | 230,0 | - | 127,0 | 175,0 | 184,0 | 209,0 | 220,0 | - | 14 |
| 16 | 120,0 | 162,0 | 175,0 | 185,0 | 195,0 | 219,0 | 229,0 | - | 112,0 | 175,0 | 184,0 | 209,0 | 218,0 | - | 16 |
| 18 | 107,0 | 161,0 | 175,0 | 185,0 | 195,0 | 219,0 | 228,0 | - | 99,0 | 175,0 | 184,0 | 209,0 | 218,0 | - | 18 |
| 20 | 95,5 | 161,0 | 175,0 | 185,0 | 195,0 | 219,0 | 224,0 | - | 88,0 | 175,0 | 183,0 | 209,0 | 214,0 | - | 20 |
| 22 | 86,0 | 160,0 | 175,0 | 185,0 | 195,0 | 219,0 | 223,0 | - | 78,5 | 175,0 | 183,0 | 208,0 | 211,0 | - | 22 |
| 24 | 77,5 | 160,0 | 175,0 | 184,0 | 194,0 | 217,0 | 222,0 | - | 70,5 | 174,0 | 183,0 | 207,0 | 210,0 | - | 24 |
| 26 | 70,5 | 159,0 | 175,0 | 184,0 | 192,0 | 217,0 | 218,0 | - | 63,5 | 174,0 | 182,0 | 207,0 | 207,0 | - | 26 |
| 28 | 64,0 | 159,0 | 174,0 | 183,0 | 192,0 | 214,0 | 213,0 | - | 57,5 | 173,0 | 182,0 | 205,0 | 202,0 | - | 28 |
| 30 | 58,5 | 159,0 | 174,0 | 179,0 | 191,0 | 211,0 | 208,0 | - | 52,0 | 172,0 | 181,0 | 204,0 | 197,0 | - | 30 |
| 34 | 49,6 | 155,6 | 172,6 | 172,3 | 184,3 | 199,3 | 193,3 | - | 43,2 | 166,6 | 175,6 | 195,0 | 183,0 | - | 34 |
| 38 | 41,8 | 150,3 | 169,6 | 166,0 | 177,6 | 187,6 | 178,6 | - | 35,5 | 160,6 | 169,0 | 186,3 | 169,0 | - | 38 |
| 42 | 35,0 | 146,0 | 167,0 | 162,0 | 171,0 | 177,0 | 164,0 | - | 28,9 | 156,0 | 163,0 | 178,0 | 155,0 | - | 42 |
| 46 | 28,7 | 140,6 | 156,0 | 153,3 | 155,0 | 165,0 | 151,3 | - | 23,2 | 151,0 | 151,6 | 165,3 | 142,3 | - | 46 |
| 50 | 23,2 | 134,6 | 143,6 | 142,6 | 139,6 | 152,3 | 139,0 | - | 18,0 | 141,6 | 138,6 | 151,3 | 130,3 | - | 50 |
| 54 | 18,5 | 130,0 | 129,0 | 128,0 | 125,0 | 137,0 | 127,0 | - | 13,4 | 127,0 | 124,0 | 136,0 | 119,0 | - | 54 |
| 58 | 14,8 | 119,3 | 117,6 | 116,6 | 113,6 | 124,3 | 116,3 | - | 9,7 | 115,6 | 112,6 | 123,3 | 108,3 | - | 58 |
| 62 | 11,5 | 109,3 | 107,5 | 106,3 | 103,0 | 113,2 | 106,5 | - | 6,4 | 105,4 | 102,7 | 112,3 | 98,5 | - | 62 |
| 65 | 9,3 | 102,3 | 100,7 | 99,3 | 96,6 | 106,0 | 99,7 | - | 4,2 | 98,5 | 95,8 | 105,3 | 92,1 | - | 65 |
| 66 | 8,6 | 100,0 | 98,5 | 97,0 | 94,5 | 104,0 | 97,5 | - | - | 96,0 | 93,5 | 103,0 | 90,0 | - | 66 |
| 70 | 6,2 | 92,6 | 90,6 | 89,3 | 87,1 | 96,0 | 89,1 | - | - | 88,6 | 86,1 | 95,0 | 82,0 | - | 70 |
| 73 | 4,4 | 87,5 | 85,4 | 84,0 | 81,9 | 90,3 | 83,1 | - | - | 83,4 | 80,9 | 89,3 | 76,2 | - | 73 |
| 74 | - | 85,9 | 83,8 | 82,5 | 80,3 | 88,6 | 81,3 | - | - | 81,8 | 79,3 | 87,6 | 74,5 | - | 74 |
| 78 | - | 79,5 | 77,5 | 76,5 | 74,0 | 82,0 | 74,0 | - | - | 75,5 | 73,0 | 81,0 | 67,5 | - | 78 |
| 82 | - | 74,1 | 72,1 | 71,1 | 68,6 | 76,3 | 67,0 | - | - | 70,1 | 67,6 | 75,3 | 60,8 | - | 82 |
| 86 | - | 69,3 | 67,3 | 66,1 | 63,6 | 71,0 | 60,1 | - | - | 65,1 | 62,5 | 70,0 | 54,5 | - | 86 |
| 90 | - | 65,0 | 63,0 | 61,5 | 59,0 | 66,0 | 54,0 | - | - | 60,5 | 57,5 | 65,0 | 48,6 | - | 90 |
| 94 | - | 61,0 | 59,0 | 57,5 | 54,7 | 62,0 | 48,1 | - | - | 56,5 | 53,1 | 61,0 | 42,7 | - | 94 |
| 98 | - | 57,2 | 55,2 | 54,0 | 50,7 | 58,1 | 42,2 | - | - | 53,2 | 49,1 | 57,1 | 37,0 | - | 98 |
| 101 | - | 54,5 | 52,5 | 51,5 | 48,0 | 55,5 | 37,8 | - | - | 50,5 | 46,4 | 54,4 | 33,4 | - | 101 |
| 102 | - | - | - | - | - | - | - | - | - | 49,6 | 45,5 | 53,5 | 32,2 | - | 102 |
| 103 | - | - | - | - | - | - | - | - | - | 48,8 | 44,6 | 52,5 | 30,9 | - | 103 |



| 165 t + 50 t | | 11-19 m | | 8,40 m | | 9.8 m/s | | 360° | | ISO | | | | | |
|--------------|-------|---------|-------|--------|-------|---------|-------|-------|-------|--------|-------|---------|-------|-------|-----|
| 120 m | | | | | | | | | | 123 m | | | | | |
| LSL_1 | | LSL_2 | | LSL_5 | | LSL_7 | | LSL_9 | | LSL_11 | | LSL_13 | | | |
| 0 t | | 0t-325t | | | | | | | | 0 t | | 0t-325t | | | |
| m | t | t | t | t | t | t | t | t | t | t | t | t | t | t | m |
| 14 | 132,0 | 138,0 | 153,0 | 160,0 | 176,0 | 199,0 | 206,0 | 214,0 | 123,0 | 153,0 | 166,0 | 190,0 | 197,0 | 204,0 | 14 |
| 16 | 116,0 | 137,0 | 152,0 | 160,0 | 176,0 | 199,0 | 206,0 | 214,0 | 108,0 | 153,0 | 166,0 | 190,0 | 197,0 | 204,0 | 16 |
| 18 | 103,0 | 137,0 | 152,0 | 160,0 | 176,0 | 199,0 | 206,0 | 214,0 | 95,5 | 153,0 | 166,0 | 190,0 | 197,0 | 204,0 | 18 |
| 20 | 92,5 | 137,0 | 152,0 | 160,0 | 176,0 | 199,0 | 206,0 | 213,0 | 85,0 | 152,0 | 166,0 | 190,0 | 197,0 | 204,0 | 20 |
| 22 | 83,0 | 136,0 | 151,0 | 160,0 | 176,0 | 198,0 | 205,0 | 212,0 | 76,0 | 152,0 | 166,0 | 189,0 | 196,0 | 203,0 | 22 |
| 24 | 75,0 | 135,0 | 151,0 | 160,0 | 175,0 | 197,0 | 204,0 | 211,0 | 68,0 | 152,0 | 165,0 | 189,0 | 195,0 | 201,0 | 24 |
| 26 | 68,0 | 135,0 | 151,0 | 159,0 | 174,0 | 197,0 | 204,0 | 211,0 | 61,0 | 151,0 | 164,0 | 188,0 | 195,0 | 201,0 | 26 |
| 28 | 61,5 | 134,0 | 151,0 | 158,0 | 173,0 | 196,0 | 202,0 | 207,0 | 55,0 | 150,0 | 164,0 | 187,0 | 193,0 | 198,0 | 28 |
| 30 | 56,5 | 134,0 | 150,0 | 157,0 | 172,0 | 195,0 | 201,0 | 204,0 | 49,9 | 150,0 | 163,0 | 186,0 | 192,0 | 196,0 | 30 |
| 34 | 47,6 | 132,0 | 148,6 | 153,6 | 168,3 | 188,0 | 193,6 | 193,0 | 41,3 | 148,0 | 160,0 | 181,0 | 186,0 | 186,0 | 34 |
| 38 | 39,9 | 129,6 | 147,3 | 148,0 | 163,3 | 181,0 | 186,3 | 179,3 | 33,8 | 143,0 | 155,3 | 173,6 | 179,6 | 174,0 | 38 |
| 42 | 33,3 | 127,0 | 146,0 | 144,0 | 157,0 | 174,0 | 179,0 | 166,0 | 27,4 | 139,0 | 150,0 | 167,0 | 173,0 | 159,0 | 42 |
| 46 | 27,9 | 123,6 | 141,0 | 139,0 | 149,6 | 164,0 | 165,0 | 152,6 | 22,0 | 135,6 | 145,3 | 159,3 | 162,3 | 146,3 | 46 |
| 50 | 22,8 | 118,6 | 136,0 | 133,0 | 138,6 | 151,0 | 150,3 | 138,6 | 17,0 | 130,6 | 136,3 | 148,6 | 149,3 | 133,3 | 50 |
| 54 | 18,1 | 116,0 | 128,0 | 127,0 | 124,0 | 135,0 | 135,0 | 126,0 | 12,4 | 126,0 | 123,0 | 134,0 | 134,0 | 120,0 | 54 |
| 58 | 14,3 | 112,3 | 116,6 | 115,6 | 112,6 | 123,0 | 123,0 | 114,0 | 8,7 | 114,6 | 111,0 | 122,0 | 122,0 | 108,0 | 58 |
| 62 | 11,0 | 107,3 | 106,5 | 105,4 | 102,3 | 111,6 | 111,0 | 102,5 | 5,3 | 104,3 | 101,3 | 110,6 | 111,0 | 97,0 | 62 |
| 63 | 10,3 | 105,5 | 104,2 | 103,1 | 100,0 | 109,0 | 108,7 | 100,0 | 4,6 | 102,0 | 99,0 | 108,2 | 108,5 | 94,5 | 63 |
| 66 | 8,1 | 100,0 | 97,5 | 96,0 | 93,0 | 102,0 | 102,0 | 92,5 | - | 95,5 | 92,0 | 101,0 | 101,0 | 87,0 | 66 |
| 70 | 5,6 | 92,3 | 89,8 | 88,6 | 85,3 | 94,3 | 94,0 | 83,1 | - | 87,8 | 84,3 | 93,3 | 93,0 | 78,0 | 70 |
| 72 | 4,4 | 88,5 | 86,0 | 85,0 | 81,5 | 90,5 | 90,0 | 78,5 | - | 84,0 | 80,5 | 89,5 | 89,0 | 73,5 | 72 |
| 74 | - | 85,3 | 82,8 | 81,8 | 78,3 | 87,1 | 86,6 | 74,6 | - | 80,8 | 77,3 | 86,1 | 85,6 | 69,6 | 74 |
| 78 | - | 79,0 | 76,5 | 75,5 | 72,0 | 80,5 | 80,0 | 67,0 | - | 74,5 | 71,0 | 79,5 | 79,0 | 62,0 | 78 |
| 82 | - | 73,6 | 71,1 | 70,1 | 67,0 | 74,8 | 74,3 | 60,6 | - | 69,1 | 65,6 | 73,8 | 73,3 | 56,0 | 82 |
| 86 | - | 68,8 | 66,3 | 65,1 | 61,8 | 69,5 | 69,0 | 55,1 | - | 64,1 | 60,5 | 68,5 | 67,9 | 50,4 | 86 |
| 90 | - | 64,5 | 62,0 | 60,5 | 56,5 | 64,5 | 64,0 | 50,5 | - | 59,5 | 55,5 | 63,5 | 63,0 | 45,7 | 90 |
| 94 | - | 60,5 | 58,0 | 56,5 | 52,1 | 60,5 | 60,0 | 47,3 | - | 55,7 | 51,1 | 59,5 | 58,6 | 42,1 | 94 |
| 98 | - | 56,6 | 54,0 | 52,9 | 48,0 | 56,6 | 56,1 | 44,8 | - | 52,2 | 46,9 | 55,5 | 54,6 | 39,2 | 98 |
| 102 | - | 53,0 | 51,0 | 49,7 | 44,2 | 53,0 | 52,5 | 43,0 | - | 48,6 | 43,0 | 51,5 | 51,0 | 36,9 | 102 |
| 106 | - | 50,0 | 47,9 | 46,5 | 40,9 | 49,7 | 49,1 | 42,3 | - | 45,2 | 39,6 | 48,2 | 47,7 | 35,9 | 106 |
| 108 | - | - | - | - | - | - | - | - | - | 43,5 | 38,0 | 46,6 | 46,1 | 35,4 | 108 |

| | | | | | | | | |
|--|----|-----|------|------|------|------|------|------|
| | 0t | 65t | 125t | 165t | 205t | 245t | 285t | 325t |
|--|----|-----|------|------|------|------|------|------|

| 165 t + 50 t | | 11-19 m | | 8,40 m | | 9.8 m/s | | 360° | | ISO | | | | | |
|--------------|-------|---------|-------|--------|-------|---------|-------|-------|-------|--------|-------|---------|-------|-------|-----|
| 126 m | | | | | | | | | | 129 m | | | | | |
| LSL_1 | | LSL_2 | | LSL_5 | | LSL_7 | | LSL_9 | | LSL_11 | | LSL_13 | | | |
| 0 t | | 0t-325t | | | | | | | | 0 t | | 0t-325t | | | |
| m | t | t | t | t | t | t | t | t | t | t | t | t | t | t | m |
| 14 | 116,0 | 119,0 | 133,0 | 146,0 | 156,0 | 179,0 | 187,0 | 195,0 | - | - | - | - | - | - | 14 |
| 15 | 114,0 | 118,5 | 132,5 | 146,0 | 156,0 | 179,0 | 187,0 | 195,0 | 109,0 | 137,0 | 148,0 | 171,0 | 178,0 | 186,0 | 15 |
| 16 | 112,0 | 118,0 | 132,0 | 146,0 | 156,0 | 179,0 | 187,0 | 195,0 | 102,0 | 137,0 | 148,0 | 171,0 | 178,0 | 186,0 | 16 |
| 18 | 100,0 | 118,0 | 132,0 | 146,0 | 156,0 | 178,0 | 187,0 | 195,0 | 90,5 | 137,0 | 147,0 | 170,0 | 178,0 | 186,0 | 18 |
| 20 | 89,5 | 118,0 | 132,0 | 145,0 | 156,0 | 178,0 | 187,0 | 195,0 | 80,5 | 136,0 | 147,0 | 170,0 | 178,0 | 186,0 | 20 |
| 22 | 80,5 | 117,0 | 132,0 | 145,0 | 156,0 | 177,0 | 187,0 | 194,0 | 71,5 | 136,0 | 147,0 | 169,0 | 178,0 | 185,0 | 22 |
| 24 | 72,5 | 116,0 | 131,0 | 145,0 | 156,0 | 176,0 | 186,0 | 194,0 | 64,0 | 136,0 | 147,0 | 168,0 | 177,0 | 185,0 | 24 |
| 26 | 66,0 | 115,0 | 130,0 | 144,0 | 155,0 | 175,0 | 185,0 | 192,0 | 57,5 | 135,0 | 146,0 | 168,0 | 176,0 | 183,0 | 26 |
| 28 | 60,0 | 114,0 | 130,0 | 144,0 | 154,0 | 175,0 | 185,0 | 190,0 | 51,5 | 135,0 | 145,0 | 167,0 | 176,0 | 183,0 | 28 |
| 30 | 54,5 | 114,0 | 130,0 | 143,0 | 153,0 | 173,0 | 183,0 | 189,0 | 46,6 | 134,0 | 145,0 | 166,0 | 174,0 | 181,0 | 30 |
| 34 | 46,0 | 112,3 | 128,6 | 141,6 | 151,6 | 169,6 | 178,6 | 181,6 | 38,1 | 133,3 | 143,0 | 163,3 | 171,0 | 175,6 | 34 |
| 38 | 38,6 | 110,6 | 127,0 | 139,0 | 147,3 | 165,0 | 171,6 | 173,3 | 30,7 | 131,3 | 139,6 | 159,0 | 164,6 | 170,0 | 38 |
| 42 | 32,2 | 108,0 | 125,0 | 135,0 | 142,0 | 159,0 | 165,0 | 164,0 | 24,5 | 128,0 | 135,0 | 153,0 | 158,0 | 162,0 | 42 |
| 46 | 27,1 | 106,0 | 123,0 | 131,0 | 138,0 | 152,6 | 155,6 | 152,6 | 19,5 | 124,6 | 130,0 | 146,6 | 149,3 | 152,0 | 46 |
| 50 | 22,2 | 103,3 | 119,0 | 127,3 | 131,6 | 144,6 | 145,6 | 142,6 | 15,0 | 121,6 | 125,3 | 140,3 | 141,3 | 142,3 | 50 |
| 54 | 17,5 | 100,0 | 117,0 | 124,0 | 123,0 | 134,0 | 133,0 | 132,0 | 11,0 | 119,0 | 120,0 | 133,0 | 132,0 | 131,0 | 54 |
| 58 | 13,7 | 97,0 | 112,3 | 113,3 | 111,0 | 121,3 | 121,0 | 120,0 | 7,3 | 111,6 | 109,3 | 120,2 | 119,0 | 119,0 | 58 |
| 61 | 11,1 | 94,8 | 108,7 | 105,6 | 102,8 | 112,6 | 112,5 | 111,5 | 4,7 | 105,0 | 101,8 | 111,6 | 111,5 | 110,5 | 61 |
| 62 | 10,4 | 94,1 | 106,5 | 103,3 | 100,6 | 110,3 | 110,0 | 109,1 | - | 102,8 | 99,6 | 109,3 | 109,1 | 108,1 | 62 |
| 66 | 7,5 | 91,5 | 97,5 | 95,0 | 92,0 | 101,0 | 100,0 | 99,5 | - | 94,0 | 91,0 | 100,0 | 99,5 | 98,5 | 66 |
| 70 | 5,0 | 89,0 | 89,8 | 87,3 | 84,3 | 93,0 | 92,3 | 90,1 | - | 86,3 | 83,0 | 91,6 | 91,1 | 90,5 | 70 |
| 71 | 4,4 | 88,5 | 87,9 | 85,4 | 82,4 | 91,0 | 90,4 | 87,8 | - | 84,4 | 81,0 | 89,5 | 89,0 | 88,5 | 71 |
| 74 | - | 84,8 | 82,8 | 80,3 | 77,1 | 85,5 | 85,0 | 81,1 | - | 79,3 | 75,5 | 84,1 | 83,6 | 82,5 | 74 |
| 78 | - | 78,5 | 76,5 | 74,0 | 70,5 | 78,5 | 78,0 | 72,5 | - | 73,0 | 68,5 | 77,5 | 77,0 | 74,5 | 78 |
| 82 | - | 73,1 | 71,1 | 68,6 | 64,8 | 72,8 | 72,3 | 65,1 | - | 67,6 | 63,0 | 70,5 | 70,3 | 66,5 | 82 |
| 86 | - | 68,1 | 66,1 | 63,6 | 59,3 | 67,6 | 67,0 | 58,0 | - | 62,6 | 57,5 | 64,0 | 64,0 | 59,3 | 86 |
| 90 | - | 63,5 | 61,5 | 59,0 | 54,0 | 63,0 | 62,5 | 52,5 | - | 58,0 | 52,5 | 58,0 | 58,0 | 53,0 | 90 |
| 94 | - | 59,5 | 57,5 | 54,7 | 49,7 | 57,6 | 57,8 | 48,2 | - | 53,3 | 48,2 | 53,0 | 53,0 | 48,0 | 94 |
| 98 | - | 55,8 | 54,0 | 50,6 | 45,6 | 52,9 | 53,4 | 44,6 | - | 49,1 | 44,1 | 48,3 | 48,5 | 43,8 | 98 |
| 102 | - | 52,5 | 50,5 | 46,8 | 41,7 | 48,9 | 49,3 | 41,7 | - | 45,3 | 40,2 | 44,1 | 44,5 | 40,4 | 102 |
| 106 | - | 48,2 | 47,5 | 43,3 | 38,2 | 45,5 | 46,0 | 40,3 | - | 41,8 | 36,7 | 40,5 | 41,0 | 38,4 | 106 |
| 110 | - | 42,7 | 43,2 | 40,1 | 35,0 | 42,4 | 43,0 | 39,4 | - | 38,6 | 33,5 | 37,3 | 37,8 | 37,0 | 110 |
| 111 | - | 41,3 | 41,9 | 39,4 | 34,3 | 41,7 | 42,4 | 39,3 | - | 37,8 | 32,8 | 36,6 | 37,1 | 36,9 | 111 |
| 114 | - | - | - | - | - | - | - | - | - | 35,7 | 30,6 | 34,5 | 35,2 | 36,8 | 114 |

0t
65t
125t
165t
205t
245t
285t
325t

| 165 t + 50 t | | 11-19 m | | 8,40 m | | 9.8 m/s | | 360° | | ISO | | | | | | | | | |
|--------------|------|---------|-------|--------|-------|---------|-------|-------|-------|--------|-------|---------|-------|--------|-------|-------|-------|-----|--|
| 132 m | | | | | | | | | | 135 m | | | | | | | | | |
| LSL_1 | | LSL_2 | | LSL_5 | | LSL_7 | | LSL_9 | | LSL_11 | | LSL_13 | | LSL_15 | | | | | |
| 0 t | | 0t-325t | | | | | | | | 0 t | | 0t-325t | | | | | | | |
| m | t | t | t | t | t | t | t | t | t | t | t | t | t | t | t | t | t | m | |
| 15 | 98,5 | 101,0 | 115,0 | 127,0 | 138,0 | 156,0 | 163,0 | 179,0 | 190,0 | 105,0 | 121,0 | 130,0 | 148,0 | 155,0 | 170,0 | 181,0 | 181,0 | 15 | |
| 16 | 98,0 | 101,0 | 115,0 | 127,0 | 138,0 | 156,0 | 163,0 | 179,0 | 190,0 | 99,0 | 121,0 | 130,0 | 148,0 | 155,0 | 170,0 | 181,0 | 181,0 | 16 | |
| 18 | 96,5 | 100,0 | 115,0 | 127,0 | 137,0 | 156,0 | 163,0 | 178,0 | 190,0 | 87,0 | 121,0 | 130,0 | 148,0 | 155,0 | 170,0 | 181,0 | 181,0 | 18 | |
| 20 | 86,5 | 100,0 | 114,0 | 127,0 | 137,0 | 156,0 | 163,0 | 177,0 | 190,0 | 77,5 | 121,0 | 130,0 | 148,0 | 155,0 | 170,0 | 181,0 | 181,0 | 20 | |
| 22 | 78,0 | 99,5 | 114,0 | 127,0 | 137,0 | 156,0 | 162,0 | 177,0 | 190,0 | 69,0 | 120,0 | 129,0 | 148,0 | 154,0 | 169,0 | 181,0 | 181,0 | 22 | |
| 24 | 70,0 | 98,5 | 113,0 | 126,0 | 137,0 | 155,0 | 162,0 | 176,0 | 190,0 | 61,5 | 120,0 | 129,0 | 147,0 | 154,0 | 168,0 | 181,0 | 181,0 | 24 | |
| 26 | 63,5 | 98,0 | 113,0 | 126,0 | 136,0 | 155,0 | 161,0 | 175,0 | 190,0 | 55,0 | 120,0 | 129,0 | 147,0 | 153,0 | 167,0 | 181,0 | 181,0 | 26 | |
| 28 | 58,0 | 97,0 | 112,0 | 125,0 | 136,0 | 154,0 | 161,0 | 175,0 | 190,0 | 49,6 | 119,0 | 128,0 | 147,0 | 153,0 | 167,0 | 181,0 | 181,0 | 28 | |
| 30 | 52,5 | 96,0 | 112,0 | 125,0 | 135,0 | 153,0 | 159,0 | 174,0 | 189,0 | 44,6 | 118,0 | 128,0 | 146,0 | 152,0 | 166,0 | 179,5 | 179,5 | 30 | |
| 34 | 44,2 | 95,0 | 111,3 | 123,6 | 133,6 | 149,6 | 155,6 | 171,0 | 186,0 | 36,3 | 117,3 | 126,6 | 144,0 | 150,0 | 164,3 | 177,0 | 177,0 | 34 | |
| 38 | 36,9 | 93,3 | 110,0 | 121,3 | 131,3 | 144,3 | 148,6 | 165,3 | 178,5 | 29,1 | 115,6 | 124,6 | 140,0 | 144,3 | 158,6 | 172,0 | 172,0 | 38 | |
| 42 | 30,6 | 91,0 | 108,0 | 118,0 | 128,0 | 140,0 | 144,0 | 156,0 | 166,0 | 22,9 | 113,0 | 122,0 | 134,0 | 139,0 | 150,0 | 161,3 | 161,3 | 42 | |
| 46 | 25,6 | 88,8 | 106,0 | 115,3 | 124,6 | 135,0 | 139,0 | 146,0 | 152,0 | 18,0 | 110,3 | 118,6 | 130,0 | 134,0 | 140,6 | 148,0 | 148,0 | 46 | |
| 50 | 21,2 | 87,0 | 104,0 | 112,0 | 121,6 | 129,6 | 133,0 | 135,3 | 139,3 | 13,6 | 108,0 | 115,6 | 125,6 | 129,3 | 130,6 | 136,0 | 136,0 | 50 | |
| 54 | 17,3 | 85,0 | 102,0 | 110,0 | 119,0 | 126,0 | 129,0 | 126,0 | 127,0 | 9,8 | 106,0 | 113,0 | 123,0 | 126,0 | 120,0 | 124,3 | 124,3 | 54 | |
| 58 | 13,6 | 82,1 | 99,0 | 106,0 | 111,0 | 118,6 | 120,2 | 116,6 | 115,0 | 6,2 | 104,0 | 109,0 | 118,2 | 120,0 | 110,8 | 113,0 | 113,0 | 58 | |
| 60 | 11,8 | 81,0 | 98,0 | 105,0 | 106,0 | 115,0 | 115,0 | 112,0 | 110,0 | 4,5 | 103,0 | 104,0 | 114,0 | 114,0 | 106,0 | 108,1 | 108,1 | 60 | |
| 62 | 10,3 | 79,0 | 95,7 | 102,0 | 101,5 | 110,3 | 110,0 | 106,6 | 105,0 | - | 99,6 | 99,8 | 109,3 | 109,1 | 101,0 | 103,3 | 103,3 | 62 | |
| 66 | 7,3 | 77,0 | 94,0 | 94,0 | 92,5 | 101,0 | 100,0 | 96,0 | 95,8 | - | 93,0 | 91,5 | 100,0 | 99,5 | 91,0 | 94,1 | 94,1 | 66 | |
| 70 | 4,8 | 74,6 | 88,0 | 86,3 | 84,8 | 92,6 | 92,3 | 86,3 | 87,5 | - | 85,6 | 83,8 | 91,6 | 91,5 | 81,6 | 85,5 | 85,5 | 70 | |
| 71 | 4,2 | 73,8 | 86,5 | 84,4 | 82,9 | 90,5 | 90,4 | 83,9 | 85,5 | - | 83,8 | 81,9 | 89,5 | 89,5 | 79,4 | 83,5 | 83,5 | 71 | |
| 74 | - | 72,0 | 81,8 | 79,3 | 77,8 | 85,1 | 85,0 | 77,1 | 79,8 | - | 78,8 | 76,8 | 84,1 | 84,0 | 73,3 | 77,8 | 77,8 | 74 | |
| 78 | - | 70,0 | 75,5 | 73,0 | 71,5 | 78,5 | 78,0 | 68,5 | 72,8 | - | 72,5 | 70,5 | 77,5 | 77,0 | 65,0 | 70,6 | 70,6 | 78 | |
| 82 | - | 67,5 | 70,1 | 67,6 | 65,8 | 72,8 | 72,3 | 61,3 | 66,5 | - | 67,1 | 64,5 | 71,8 | 71,3 | 57,3 | 64,5 | 64,5 | 82 | |
| 86 | - | 64,1 | 65,1 | 62,8 | 60,8 | 67,5 | 67,1 | 54,5 | 61,4 | - | 61,8 | 59,0 | 66,5 | 66,2 | 50,9 | 59,5 | 59,5 | 86 | |
| 90 | - | 59,5 | 60,5 | 58,5 | 56,0 | 62,5 | 62,5 | 48,5 | 56,5 | - | 57,0 | 54,0 | 61,5 | 61,0 | 44,9 | 54,6 | 54,6 | 90 | |
| 94 | - | 54,8 | 56,5 | 54,1 | 51,5 | 58,1 | 57,8 | 43,5 | 51,5 | - | 52,3 | 49,8 | 57,1 | 56,6 | 39,8 | 50,0 | 50,0 | 94 | |
| 98 | - | 50,4 | 53,2 | 50,0 | 47,3 | 54,0 | 53,6 | 39,0 | 47,3 | - | 48,1 | 45,8 | 52,8 | 52,4 | 35,3 | 45,6 | 45,6 | 98 | |
| 102 | - | 46,1 | 49,6 | 46,0 | 43,3 | 50,0 | 49,9 | 35,2 | 43,3 | - | 44,5 | 41,9 | 48,5 | 48,3 | 31,3 | 41,5 | 41,5 | 102 | |
| 106 | - | 41,4 | 46,4 | 42,4 | 39,8 | 46,2 | 46,1 | 32,5 | 39,6 | - | 40,9 | 38,2 | 44,7 | 44,5 | 28,2 | 37,8 | 37,8 | 106 | |
| 110 | - | 36,7 | 41,9 | 39,1 | 36,5 | 42,8 | 42,7 | 30,4 | 36,2 | - | 37,6 | 35,0 | 41,1 | 40,9 | 25,9 | 34,4 | 34,4 | 110 | |
| 114 | - | 32,3 | 36,2 | 36,1 | 33,5 | 39,6 | 39,5 | 28,9 | 33,1 | - | 34,6 | 32,0 | 38,0 | 37,8 | 24,1 | 31,3 | 31,3 | 114 | |
| 116 | - | 29,9 | 32,9 | 34,7 | 32,1 | 38,3 | 38,1 | 28,6 | 31,7 | - | 33,2 | 30,6 | 36,6 | 36,4 | 23,6 | 29,8 | 29,8 | 116 | |
| 118 | - | - | - | - | - | - | - | - | - | - | 31,8 | 29,2 | 35,2 | 35,0 | 23,2 | 28,4 | 28,4 | 118 | |
| 119 | - | - | - | - | - | - | - | - | - | - | 31,2 | 28,6 | 34,5 | 34,3 | 23,0 | 27,8 | 27,8 | 119 | |

0t
65t
125t
165t
205t
245t
285t
325t

LSL_15:  225 t +  50 t

| 165 t + 50 t | | 11-19 m | | 8,40 m | | 9.8 m/s | | 360° | | ISO | | | | | | | | | |
|--------------|------|---------|------|--------|-------|---------|-------|-------|-------|--------|-------|---------|-------|--------|-------|-------|-----|----|--|
| 138 m | | | | | | | | | | 141 m | | | | | | | | | |
| LSL_1 | | LSL_2 | | LSL_5 | | LSL_7 | | LSL_9 | | LSL_11 | | LSL_13 | | LSL_15 | | | | | |
| 0 t | | 0t-325t | | | | | | | | 0 t | | 0t-325t | | | | | | | |
| m | t | t | t | t | t | t | t | t | t | t | t | t | t | t | t | t | t | m | |
| 15 | 84,5 | 87,5 | 98,5 | 117,0 | 123,0 | 140,0 | 146,0 | 162,0 | 171,0 | - | - | - | - | - | - | - | - | 15 | |
| 16 | 84,5 | 87,0 | 98,5 | 117,0 | 123,0 | 140,0 | 146,0 | 162,0 | 171,0 | 93,5 | 111,0 | 116,0 | 131,0 | 139,0 | 153,0 | 163,0 | 16 | | |
| 18 | 84,0 | 86,5 | 98,0 | 117,0 | 122,0 | 140,0 | 146,0 | 162,0 | 171,0 | 82,0 | 111,0 | 116,0 | 130,0 | 139,0 | 153,0 | 163,0 | 18 | | |
| 20 | 83,0 | 86,0 | 97,5 | 117,0 | 122,0 | 139,0 | 146,0 | 162,0 | 171,0 | 72,5 | 111,0 | 116,0 | 130,0 | 139,0 | 153,0 | 163,0 | 20 | | |
| 22 | 75,5 | 85,0 | 97,0 | 117,0 | 122,0 | 139,0 | 146,0 | 162,0 | 171,0 | 64,5 | 110,0 | 115,0 | 130,0 | 139,0 | 153,0 | 163,0 | 22 | | |
| 24 | 68,0 | 84,5 | 96,5 | 116,0 | 122,0 | 138,0 | 145,0 | 161,0 | 171,0 | 57,5 | 110,0 | 115,0 | 129,0 | 138,0 | 153,0 | 162,0 | 24 | | |
| 26 | 61,5 | 83,5 | 96,0 | 116,0 | 121,0 | 137,0 | 145,0 | 161,0 | 171,0 | 51,0 | 110,0 | 115,0 | 129,0 | 138,0 | 153,0 | 162,0 | 26 | | |
| 28 | 56,0 | 82,5 | 95,0 | 115,0 | 121,0 | 136,0 | 145,0 | 160,0 | 171,0 | 45,7 | 109,0 | 114,0 | 129,0 | 138,0 | 152,0 | 162,0 | 28 | | |
| 30 | 51,0 | 82,0 | 94,5 | 115,0 | 120,0 | 135,0 | 144,0 | 160,0 | 170,0 | 40,8 | 109,0 | 114,0 | 129,0 | 137,0 | 152,0 | 161,5 | 30 | | |
| 34 | 42,8 | 80,6 | 93,5 | 113,6 | 119,3 | 132,3 | 142,0 | 154,0 | 168,0 | 32,6 | 107,6 | 112,6 | 127,6 | 134,6 | 147,3 | 159,5 | 34 | | |
| 38 | 35,6 | 79,5 | 92,1 | 112,0 | 117,6 | 128,0 | 137,6 | 146,6 | 163,5 | 25,5 | 106,3 | 111,0 | 125,3 | 131,0 | 140,6 | 156,0 | 38 | | |
| 42 | 29,4 | 77,5 | 90,5 | 110,0 | 115,0 | 124,0 | 133,0 | 138,0 | 155,0 | 19,5 | 105,0 | 109,0 | 122,0 | 127,0 | 134,0 | 149,6 | 42 | | |
| 46 | 24,5 | 75,8 | 88,8 | 107,3 | 112,3 | 119,0 | 128,6 | 128,0 | 145,0 | 14,7 | 102,3 | 106,3 | 119,3 | 122,3 | 124,0 | 141,0 | 46 | | |
| 50 | 20,1 | 74,0 | 87,1 | 104,6 | 109,6 | 114,3 | 124,3 | 117,8 | 133,0 | 10,4 | 100,0 | 104,0 | 116,6 | 119,3 | 114,3 | 129,6 | 50 | | |
| 54 | 16,3 | 72,0 | 86,0 | 102,0 | 107,0 | 110,0 | 121,0 | 107,0 | 121,8 | 6,6 | 98,0 | 102,0 | 114,0 | 116,0 | 105,0 | 119,0 | 54 | | |
| 57 | 13,9 | 71,0 | 84,7 | 100,5 | 105,0 | 107,0 | 119,0 | 99,7 | 114,0 | 4,2 | 96,5 | 100,2 | 111,2 | 112,2 | 97,7 | 111,5 | 57 | | |
| 58 | 13,1 | 70,6 | 84,3 | 100,0 | 104,0 | 106,0 | 117,0 | 97,3 | 111,0 | - | 96,0 | 99,8 | 110,5 | 111,5 | 95,3 | 109,0 | 58 | | |
| 62 | 10,0 | 69,0 | 82,2 | 96,6 | 98,0 | 101,1 | 108,3 | 88,1 | 102,0 | - | 92,8 | 95,1 | 105,0 | 105,8 | 85,8 | 99,6 | 62 | | |
| 66 | 7,1 | 67,0 | 80,5 | 91,0 | 90,0 | 97,5 | 99,0 | 79,5 | 93,1 | - | 88,5 | 87,5 | 97,0 | 97,5 | 76,5 | 90,8 | 66 | | |
| 70 | 4,5 | 65,2 | 77,8 | 84,0 | 82,6 | 90,5 | 90,6 | 70,8 | 84,5 | - | 81,8 | 80,5 | 89,6 | 89,5 | 68,1 | 82,5 | 70 | | |
| 74 | - | 62,6 | 75,3 | 76,5 | 75,6 | 83,6 | 83,1 | 62,5 | 77,1 | - | 75,0 | 73,8 | 82,5 | 82,1 | 60,1 | 75,1 | 74 | | |
| 78 | - | 61,0 | 74,0 | 68,5 | 69,0 | 77,0 | 76,5 | 55,0 | 70,1 | - | 68,0 | 67,5 | 75,5 | 75,5 | 52,5 | 68,1 | 78 | | |
| 82 | - | 58,8 | 69,6 | 60,5 | 63,0 | 71,3 | 70,8 | 48,4 | 64,0 | - | 60,0 | 61,5 | 69,9 | 69,5 | 46,0 | 62,0 | 82 | | |
| 86 | - | 56,6 | 65,3 | 52,8 | 58,0 | 65,8 | 65,5 | 42,3 | 57,6 | - | 52,4 | 56,0 | 64,5 | 64,3 | 39,9 | 56,6 | 86 | | |
| 90 | - | 54,0 | 61,0 | 46,1 | 53,0 | 61,0 | 60,5 | 36,8 | 51,9 | - | 45,3 | 51,0 | 59,5 | 59,0 | 34,3 | 51,8 | 90 | | |
| 94 | - | 50,2 | 56,6 | 40,9 | 48,6 | 56,3 | 55,8 | 32,0 | 46,8 | - | 40,2 | 46,9 | 54,5 | 54,3 | 29,5 | 47,5 | 94 | | |
| 98 | - | 46,3 | 52,8 | 36,1 | 44,5 | 51,9 | 51,4 | 27,8 | 42,2 | - | 35,4 | 42,9 | 50,0 | 49,9 | 25,2 | 42,9 | 98 | | |
| 102 | - | 42,3 | 48,4 | 31,6 | 40,6 | 47,8 | 47,3 | 24,0 | 38,0 | - | 30,9 | 39,0 | 46,0 | 45,7 | 21,4 | 38,5 | 102 | | |
| 106 | - | 38,4 | 42,4 | 27,7 | 37,0 | 44,0 | 43,5 | 21,0 | 34,1 | - | 26,9 | 35,5 | 42,1 | 41,8 | 18,2 | 34,4 | 106 | | |
| 110 | - | 35,0 | 36,7 | 24,1 | 33,7 | 40,3 | 39,9 | 18,6 | 30,7 | - | 23,2 | 32,2 | 38,6 | 38,3 | 15,5 | 30,7 | 110 | | |
| 114 | - | 31,2 | 31,1 | 20,9 | 30,7 | 37,1 | 36,7 | 16,6 | 27,6 | - | 20,0 | 29,2 | 35,3 | 35,0 | 13,3 | 27,5 | 114 | | |
| 118 | - | 27,2 | 25,1 | 18,3 | 27,9 | 34,1 | 33,9 | 15,3 | 24,9 | - | 17,1 | 26,4 | 32,4 | 32,1 | 11,8 | 24,5 | 118 | | |
| 121 | - | 24,3 | 21,0 | 16,4 | 26,0 | 32,0 | 31,8 | 14,6 | 23,2 | - | 15,2 | 24,5 | 30,3 | 30,0 | 10,9 | 22,7 | 121 | | |
| 122 | - | - | - | - | - | - | - | - | - | - | 14,6 | 23,9 | 29,7 | 29,4 | 10,7 | 22,1 | 122 | | |
| 124 | - | - | - | - | - | - | - | - | - | - | 13,5 | 22,7 | 28,5 | 28,2 | 10,4 | 21,0 | 124 | | |

0t
65t
125t
165t
205t
245t
285t
325t

LSL_15:  225 t +  50 t

| 165 t + 50 t | | 11-19 m | | 8,40 m | | 9.8 m/s | | 360° | | ISO | | | | | | | |
|--------------|------|---------|------|--------|-------|---------|-------|-------|-------|--------|------|---------|-------|--------|-------|-------|-----|
| 144 m | | | | | | | | | | 147 m | | | | | | | |
| LSL_1 | | LSL_2 | | LSL_5 | | LSL_7 | | LSL_9 | | LSL_11 | | LSL_13 | | LSL_15 | | | |
| 0 t | | 0t-325t | | | | | | | | 0 t | | 0t-325t | | | | | |
| m | t | t | t | t | t | t | t | t | t | t | t | t | t | t | t | t | m |
| 16 | 73,0 | 75,5 | 86,0 | 102,0 | 106,0 | 126,0 | 133,0 | 142,0 | 156,0 | 90,0 | 97,0 | 101,0 | 120,0 | 126,0 | 135,0 | 148,0 | 16 |
| 18 | 72,5 | 75,0 | 85,5 | 102,0 | 106,0 | 125,0 | 133,0 | 142,0 | 156,0 | 79,0 | 96,5 | 100,0 | 119,0 | 126,0 | 135,0 | 148,0 | 18 |
| 20 | 72,0 | 74,0 | 85,0 | 101,0 | 105,0 | 125,0 | 133,0 | 141,0 | 156,0 | 70,0 | 96,0 | 100,0 | 119,0 | 126,0 | 135,0 | 148,0 | 20 |
| 22 | 71,0 | 73,5 | 84,5 | 101,0 | 105,0 | 125,0 | 132,0 | 141,0 | 156,0 | 62,0 | 96,0 | 100,0 | 119,0 | 126,0 | 135,0 | 148,0 | 22 |
| 24 | 65,5 | 72,5 | 84,0 | 101,0 | 105,0 | 124,0 | 132,0 | 140,0 | 156,0 | 55,0 | 95,5 | 100,0 | 119,0 | 125,0 | 135,0 | 148,0 | 24 |
| 26 | 59,0 | 71,5 | 83,0 | 101,0 | 105,0 | 124,0 | 131,0 | 140,0 | 155,0 | 49,0 | 95,5 | 99,5 | 118,0 | 125,0 | 134,0 | 147,0 | 26 |
| 28 | 53,5 | 71,0 | 82,5 | 100,0 | 104,0 | 124,0 | 130,0 | 139,0 | 154,0 | 43,6 | 95,5 | 99,0 | 118,0 | 124,0 | 133,0 | 146,0 | 28 |
| 30 | 48,9 | 70,0 | 81,5 | 100,0 | 103,0 | 124,0 | 130,0 | 138,0 | 153,5 | 38,8 | 95,0 | 98,5 | 118,0 | 124,0 | 132,0 | 145,5 | 30 |
| 34 | 40,8 | 68,3 | 80,3 | 99,0 | 101,6 | 122,0 | 127,3 | 135,3 | 152,0 | 30,8 | 94,0 | 97,1 | 116,6 | 122,0 | 130,0 | 144,0 | 34 |
| 38 | 33,7 | 66,8 | 79,3 | 97,8 | 100,3 | 120,0 | 122,3 | 131,3 | 149,0 | 23,9 | 93,0 | 96,0 | 114,6 | 119,3 | 126,0 | 141,5 | 38 |
| 42 | 27,6 | 65,5 | 78,0 | 96,5 | 99,0 | 118,0 | 119,0 | 127,0 | 144,0 | 18,0 | 92,0 | 95,0 | 112,0 | 116,0 | 122,0 | 137,3 | 42 |
| 46 | 22,8 | 63,8 | 76,3 | 94,5 | 95,6 | 115,3 | 114,6 | 122,3 | 138,0 | 13,2 | 90,0 | 93,0 | 109,3 | 111,6 | 117,6 | 132,0 | 46 |
| 50 | 18,5 | 62,0 | 74,6 | 92,5 | 92,1 | 112,6 | 110,0 | 117,0 | 127,3 | 9,0 | 88,1 | 90,0 | 107,0 | 108,0 | 112,0 | 122,6 | 50 |
| 54 | 14,7 | 60,0 | 73,0 | 90,5 | 89,5 | 110,0 | 106,0 | 113,0 | 116,6 | 5,3 | 86,5 | 88,0 | 105,0 | 105,0 | 109,0 | 113,0 | 54 |
| 55 | 13,9 | 59,5 | 72,5 | 90,0 | 89,0 | 109,0 | 105,0 | 111,0 | 114,0 | 4,5 | 86,0 | 86,7 | 104,3 | 103,8 | 107,1 | 110,7 | 55 |
| 58 | 11,5 | 58,3 | 71,3 | 88,7 | 86,3 | 107,0 | 102,0 | 108,0 | 107,0 | - | 84,8 | 84,7 | 102,3 | 101,3 | 104,0 | 104,0 | 58 |
| 62 | 8,6 | 56,6 | 69,5 | 86,1 | 83,5 | 102,5 | 98,3 | 102,6 | 98,0 | - | 83,1 | 81,8 | 98,3 | 97,8 | 99,3 | 95,3 | 62 |
| 66 | 6,0 | 55,0 | 68,0 | 84,5 | 80,5 | 95,5 | 95,0 | 96,0 | 89,5 | - | 81,5 | 79,5 | 93,0 | 93,5 | 94,0 | 87,1 | 66 |
| 69 | 4,0 | 53,7 | 66,0 | 80,7 | 78,7 | 90,0 | 90,0 | 90,2 | 83,5 | - | 78,2 | 77,7 | 87,7 | 88,2 | 88,2 | 81,4 | 69 |
| 70 | - | 53,3 | 65,6 | 79,5 | 78,1 | 88,1 | 88,3 | 88,3 | 81,5 | - | 77,1 | 77,1 | 86,0 | 86,5 | 86,3 | 79,5 | 70 |
| 74 | - | 51,6 | 63,8 | 74,3 | 74,3 | 81,1 | 81,6 | 81,0 | 74,1 | - | 72,3 | 73,0 | 79,3 | 79,6 | 79,1 | 72,3 | 74 |
| 78 | - | 50,0 | 62,0 | 69,0 | 69,0 | 74,5 | 75,0 | 74,0 | 67,5 | - | 67,0 | 67,0 | 73,0 | 73,0 | 72,5 | 65,5 | 78 |
| 82 | - | 48,3 | 60,6 | 63,4 | 63,4 | 68,9 | 69,0 | 68,2 | 61,5 | - | 61,6 | 61,6 | 66,6 | 67,0 | 66,5 | 59,5 | 82 |
| 86 | - | 46,7 | 58,3 | 58,5 | 58,5 | 63,5 | 63,5 | 63,0 | 56,1 | - | 56,3 | 56,5 | 61,5 | 61,5 | 61,0 | 54,1 | 86 |
| 90 | - | 44,9 | 57,0 | 53,5 | 53,5 | 58,5 | 58,5 | 58,0 | 51,2 | - | 51,0 | 51,5 | 56,5 | 56,5 | 56,0 | 49,1 | 90 |
| 94 | - | 41,9 | 52,5 | 47,7 | 49,1 | 53,5 | 53,8 | 53,3 | 46,7 | - | 45,6 | 47,3 | 52,1 | 52,1 | 51,5 | 44,7 | 94 |
| 98 | - | 38,4 | 47,5 | 42,0 | 45,0 | 49,0 | 49,4 | 48,8 | 42,5 | - | 40,2 | 43,4 | 47,8 | 47,7 | 46,9 | 40,6 | 98 |
| 102 | - | 35,0 | 43,0 | 36,4 | 41,2 | 45,1 | 45,2 | 44,6 | 38,6 | - | 34,9 | 39,7 | 43,6 | 43,5 | 42,2 | 36,7 | 102 |
| 106 | - | 31,7 | 38,0 | 31,4 | 37,3 | 41,2 | 41,2 | 40,7 | 34,9 | - | 30,1 | 36,2 | 39,8 | 39,7 | 37,8 | 33,1 | 106 |
| 110 | - | 28,5 | 33,0 | 26,9 | 32,6 | 37,7 | 37,3 | 37,2 | 31,4 | - | 25,8 | 32,2 | 36,2 | 36,1 | 33,8 | 29,7 | 110 |
| 114 | - | 25,0 | 28,5 | 23,0 | 27,5 | 34,4 | 33,3 | 33,8 | 28,3 | - | 21,8 | 27,6 | 32,9 | 32,8 | 30,1 | 26,5 | 114 |
| 118 | - | 21,5 | 23,3 | 19,6 | 23,4 | 31,4 | 29,6 | 30,8 | 25,3 | - | 18,4 | 23,4 | 29,8 | 29,0 | 26,9 | 23,5 | 118 |
| 122 | - | 18,0 | 18,3 | 16,6 | 20,2 | 28,7 | 26,4 | 28,1 | 22,6 | - | 15,3 | 19,7 | 27,1 | 25,5 | 23,9 | 20,8 | 122 |
| 126 | - | 14,7 | 13,4 | 14,2 | 17,5 | 26,3 | 23,6 | 25,7 | 20,2 | - | 12,6 | 16,8 | 24,6 | 22,3 | 21,3 | 18,3 | 126 |
| 127 | - | 13,8 | 12,1 | 13,7 | 17,0 | 25,7 | 23,0 | 25,1 | 19,6 | - | 12,0 | 16,1 | 24,0 | 21,6 | 20,7 | 17,7 | 127 |
| 129 | - | - | - | - | - | - | - | - | - | - | 10,9 | 14,9 | 22,9 | 20,4 | 19,7 | 16,6 | 129 |



LSL_15: 225 t + 50 t

| 165 t + 50 t | | 11-19 m | | | | | | 8,40 m | | 9.8 m/s | | 360° | | ISO | | | | | | | | | |
|--------------|------|-----------|------|-------|-------|--------|-------|--------|------|-----------|-------|-------|-------|-------|-------|-------|-------|--------|-------|--------|-------|--------|-----|
| 150 m | | | | | | | | 153 m | | | | | | | | | | | | | | | |
| LSL_5 | | LSL_7 | | LSL_9 | | LSL_11 | | LSL_13 | | LSL_15 | | LSL_5 | | LSL_7 | | LSL_9 | | LSL_11 | | LSL_13 | | LSL_15 | |
| 0 t | | 0 t-325 t | | | | | | 0 t | | 0 t-325 t | | | | | | 0 t | | | | | | | |
| m | t | t | t | t | t | t | t | t | t | t | t | t | t | t | t | t | t | t | t | t | t | t | m |
| 16 | 87,0 | 90,5 | 95,5 | 113,0 | 119,0 | 129,0 | 141,0 | - | - | - | - | - | - | - | - | - | - | - | - | - | - | - | 16 |
| 17 | 82,7 | 90,2 | 95,5 | 113,0 | 119,0 | 129,0 | 141,0 | 81,5 | 86,0 | 90,5 | 108,0 | 113,0 | 122,0 | 133,0 | 133,0 | 133,0 | 133,0 | 133,0 | 133,0 | 133,0 | 133,0 | 133,0 | 17 |
| 18 | 79,0 | 90,0 | 95,5 | 113,0 | 119,0 | 129,0 | 141,0 | 77,0 | 86,0 | 90,5 | 108,0 | 113,0 | 122,0 | 133,0 | 133,0 | 133,0 | 133,0 | 133,0 | 133,0 | 133,0 | 133,0 | 133,0 | 18 |
| 20 | 70,0 | 90,0 | 95,0 | 113,0 | 119,0 | 128,0 | 141,0 | 68,0 | 85,5 | 90,0 | 107,0 | 113,0 | 122,0 | 133,0 | 133,0 | 133,0 | 133,0 | 133,0 | 133,0 | 133,0 | 133,0 | 133,0 | 20 |
| 22 | 62,0 | 89,5 | 94,5 | 112,0 | 119,0 | 128,0 | 141,0 | 60,0 | 85,0 | 90,0 | 107,0 | 113,0 | 122,0 | 133,0 | 133,0 | 133,0 | 133,0 | 133,0 | 133,0 | 133,0 | 133,0 | 133,0 | 22 |
| 24 | 55,0 | 89,0 | 94,5 | 112,0 | 119,0 | 128,0 | 140,0 | 53,5 | 84,5 | 89,5 | 107,0 | 113,0 | 122,0 | 133,0 | 133,0 | 133,0 | 133,0 | 133,0 | 133,0 | 133,0 | 133,0 | 133,0 | 24 |
| 26 | 49,3 | 89,0 | 94,0 | 112,0 | 118,0 | 128,0 | 139,5 | 47,7 | 84,5 | 89,0 | 107,0 | 112,0 | 121,0 | 132,0 | 132,0 | 132,0 | 132,0 | 132,0 | 132,0 | 132,0 | 132,0 | 132,0 | 26 |
| 28 | 44,0 | 88,5 | 93,5 | 112,0 | 118,0 | 127,0 | 139,0 | 42,4 | 84,0 | 89,0 | 106,0 | 112,0 | 121,0 | 131,0 | 131,0 | 131,0 | 131,0 | 131,0 | 131,0 | 131,0 | 131,0 | 131,0 | 28 |
| 30 | 39,2 | 88,0 | 93,0 | 111,0 | 117,0 | 127,0 | 138,0 | 37,7 | 83,5 | 88,5 | 106,0 | 111,0 | 120,0 | 130,5 | 130,5 | 130,5 | 130,5 | 130,5 | 130,5 | 130,5 | 130,5 | 130,5 | 30 |
| 34 | 31,4 | 87,0 | 92,0 | 109,6 | 115,6 | 124,3 | 137,0 | 29,9 | 82,8 | 87,5 | 104,6 | 109,6 | 118,0 | 129,5 | 129,5 | 129,5 | 129,5 | 129,5 | 129,5 | 129,5 | 129,5 | 129,5 | 34 |
| 38 | 24,5 | 85,8 | 91,0 | 108,3 | 112,6 | 120,3 | 135,0 | 23,1 | 82,0 | 86,6 | 103,3 | 107,6 | 115,3 | 128,0 | 128,0 | 128,0 | 128,0 | 128,0 | 128,0 | 128,0 | 128,0 | 128,0 | 38 |
| 42 | 18,6 | 84,5 | 90,0 | 107,0 | 110,0 | 117,0 | 130,6 | 17,3 | 81,0 | 86,0 | 102,0 | 105,0 | 112,0 | 124,6 | 124,6 | 124,6 | 124,6 | 124,6 | 124,6 | 124,6 | 124,6 | 124,6 | 42 |
| 46 | 14,0 | 82,8 | 88,3 | 104,3 | 106,6 | 112,6 | 126,0 | 12,7 | 79,6 | 84,3 | 99,3 | 101,6 | 107,6 | 120,0 | 120,0 | 120,0 | 120,0 | 120,0 | 120,0 | 120,0 | 120,0 | 120,0 | 46 |
| 50 | 9,8 | 81,1 | 85,7 | 101,8 | 103,6 | 109,0 | 118,6 | 8,5 | 78,2 | 82,8 | 97,0 | 99,3 | 103,2 | 115,2 | 115,2 | 115,2 | 115,2 | 115,2 | 115,2 | 115,2 | 115,2 | 115,2 | 50 |
| 54 | 6,0 | 79,5 | 84,0 | 99,5 | 100,0 | 104,0 | 110,8 | 4,8 | 76,5 | 81,5 | 94,5 | 96,5 | 100,0 | 107,6 | 107,6 | 107,6 | 107,6 | 107,6 | 107,6 | 107,6 | 107,6 | 107,6 | 54 |
| 55 | 5,2 | 78,5 | 83,0 | 99,0 | 99,2 | 102,7 | 108,6 | 4,0 | 76,1 | 80,5 | 93,9 | 95,8 | 99,0 | 105,5 | 105,5 | 105,5 | 105,5 | 105,5 | 105,5 | 105,5 | 105,5 | 105,5 | 55 |
| 56 | 4,4 | 78,1 | 82,1 | 98,5 | 98,5 | 101,5 | 106,4 | - | 75,8 | 79,6 | 93,3 | 95,1 | 98,0 | 103,3 | 103,3 | 103,3 | 103,3 | 103,3 | 103,3 | 103,3 | 103,3 | 103,3 | 56 |
| 58 | - | 77,3 | 81,0 | 97,5 | 97,0 | 100,0 | 102,0 | - | 75,1 | 78,8 | 92,1 | 93,8 | 96,5 | 99,0 | 99,0 | 99,0 | 99,0 | 99,0 | 99,0 | 99,0 | 99,0 | 99,0 | 58 |
| 62 | - | 75,1 | 78,6 | 94,6 | 94,1 | 96,3 | 93,6 | - | 73,3 | 76,6 | 90,0 | 90,3 | 93,3 | 91,0 | 91,0 | 91,0 | 91,0 | 91,0 | 91,0 | 91,0 | 91,0 | 91,0 | 62 |
| 66 | - | 73,5 | 76,5 | 91,0 | 91,5 | 92,0 | 85,6 | - | 72,0 | 75,0 | 88,0 | 88,0 | 90,0 | 83,1 | 83,1 | 83,1 | 83,1 | 83,1 | 83,1 | 83,1 | 83,1 | 83,1 | 66 |
| 70 | - | 71,0 | 74,5 | 84,3 | 84,8 | 84,6 | 78,0 | - | 69,3 | 73,0 | 82,0 | 82,0 | 82,6 | 75,5 | 75,5 | 75,5 | 75,5 | 75,5 | 75,5 | 75,5 | 75,5 | 75,5 | 70 |
| 74 | - | 68,8 | 70,8 | 77,8 | 78,1 | 77,6 | 70,8 | - | 67,0 | 69,2 | 76,0 | 75,7 | 75,6 | 68,7 | 68,7 | 68,7 | 68,7 | 68,7 | 68,7 | 68,7 | 68,7 | 68,7 | 74 |
| 78 | - | 66,5 | 65,5 | 71,5 | 71,5 | 71,0 | 64,5 | - | 64,0 | 63,5 | 69,5 | 69,5 | 69,0 | 62,5 | 62,5 | 62,5 | 62,5 | 62,5 | 62,5 | 62,5 | 62,5 | 62,5 | 78 |
| 82 | - | 62,5 | 60,1 | 65,5 | 65,5 | 65,3 | 58,5 | - | 60,8 | 58,5 | 63,8 | 63,8 | 63,3 | 56,5 | 56,5 | 56,5 | 56,5 | 56,5 | 56,5 | 56,5 | 56,5 | 56,5 | 82 |
| 86 | - | 58,1 | 55,1 | 60,1 | 60,1 | 60,0 | 53,1 | - | 56,1 | 53,6 | 58,5 | 58,5 | 57,6 | 51,4 | 51,4 | 51,4 | 51,4 | 51,4 | 51,4 | 51,4 | 51,4 | 51,4 | 86 |
| 90 | - | 53,5 | 50,5 | 55,5 | 55,5 | 55,0 | 48,2 | - | 51,5 | 49,0 | 53,5 | 53,5 | 52,0 | 46,4 | 46,4 | 46,4 | 46,4 | 46,4 | 46,4 | 46,4 | 46,4 | 46,4 | 90 |
| 94 | - | 48,9 | 46,1 | 50,9 | 50,9 | 49,8 | 43,8 | - | 47,3 | 44,6 | 49,3 | 49,1 | 46,2 | 41,9 | 41,9 | 41,9 | 41,9 | 41,9 | 41,9 | 41,9 | 41,9 | 41,9 | 94 |
| 98 | - | 44,8 | 42,0 | 46,6 | 46,6 | 44,6 | 39,8 | - | 43,1 | 40,5 | 45,0 | 44,8 | 40,8 | 37,9 | 37,9 | 37,9 | 37,9 | 37,9 | 37,9 | 37,9 | 37,9 | 37,9 | 98 |
| 102 | - | 41,0 | 38,3 | 42,5 | 42,5 | 39,9 | 35,9 | - | 39,4 | 36,7 | 41,0 | 40,5 | 35,8 | 34,1 | 34,1 | 34,1 | 34,1 | 34,1 | 34,1 | 34,1 | 34,1 | 34,1 | 102 |
| 106 | - | 36,1 | 34,9 | 38,7 | 38,7 | 35,5 | 32,4 | - | 34,3 | 33,3 | 37,2 | 35,4 | 31,3 | 30,5 | 30,5 | 30,5 | 30,5 | 30,5 | 30,5 | 30,5 | 30,5 | 30,5 | 106 |
| 110 | - | 30,5 | 30,7 | 35,1 | 34,6 | 31,3 | 29,0 | - | 29,0 | 29,6 | 32,9 | 30,6 | 27,1 | 27,2 | 27,2 | 27,2 | 27,2 | 27,2 | 27,2 | 27,2 | 27,2 | 27,2 | 110 |
| 114 | - | 24,9 | 25,5 | 31,8 | 30,2 | 27,6 | 25,7 | - | 23,5 | 25,5 | 28,2 | 26,2 | 23,3 | 24,0 | 24,0 | 24,0 | 24,0 | 24,0 | 24,0 | 24,0 | 24,0 | 24,0 | 114 |
| 118 | - | 20,4 | 20,9 | 28,8 | 26,2 | 24,3 | 22,8 | - | 18,9 | 20,5 | 24,0 | 22,2 | 20,0 | 21,1 | 21,1 | 21,1 | 21,1 | 21,1 | 21,1 | 21,1 | 21,1 | 21,1 | 118 |
| 122 | - | 16,4 | 17,2 | 26,0 | 22,5 | 21,3 | 20,1 | - | 15,0 | 16,1 | 20,2 | 18,5 | 17,0 | 18,3 | 18,3 | 18,3 | 18,3 | 18,3 | 18,3 | 18,3 | 18,3 | 18,3 | 122 |
| 126 | - | 13,2 | 14,0 | 23,4 | 19,2 | 18,6 | 17,6 | - | 11,5 | 13,0 | 16,8 | 15,4 | 14,4 | 15,8 | 15,8 | 15,8 | 15,8 | 15,8 | 15,8 | 15,8 | 15,8 | 15,8 | 126 |
| 130 | - | 11,2 | 11,5 | 21,1 | 16,5 | 16,4 | 15,3 | - | 9,3 | 10,4 | 13,9 | 12,6 | 12,3 | 13,5 | 13,5 | 13,5 | 13,5 | 13,5 | 13,5 | 13,5 | 13,5 | 13,5 | 130 |
| 132 | - | 10,3 | 10,5 | 20,1 | 15,3 | 15,3 | 14,2 | - | 8,2 | 9,1 | 12,5 | 11,3 | 11,3 | 12,4 | 12,4 | 12,4 | 12,4 | 12,4 | 12,4 | 12,4 | 12,4 | 12,4 | 132 |
| 134 | - | - | - | - | - | - | - | - | 7,2 | 8,0 | 11,4 | 10,2 | 10,5 | 11,3 | 11,3 | 11,3 | 11,3 | 11,3 | 11,3 | 11,3 | 11,3 | 11,3 | 134 |

0 t 65 t 125 t 165 t 205 t 245 t 285 t 325 t

LSL_15: 225 t + 50 t

| 165 t + 50 t 11-19 m 8,40 m 9.8 m/s 360° ISO | | | | | | | | | | | | | | | | | | | | | | | |
|--|------|-----------|------|-------|-------|--------|-------|--------|------|--------|------|-----------|-------|-------|-----|-------|---|--------|---|--------|---|--------|---|
| 156 m | | | | | | | | 159 m | | | | | | | | | | | | | | | |
| LSL_5 | | LSL_7 | | LSL_9 | | LSL_11 | | LSL_13 | | LSL_15 | | LSL_5 | | LSL_7 | | LSL_9 | | LSL_11 | | LSL_13 | | LSL_15 | |
| 0 t | | 0 t-325 t | | | | | | | | 0 t | | 0 t-325 t | | | | | | | | 0 t | | | |
| m | t | t | t | t | t | t | t | t | t | t | t | t | t | t | t | t | t | t | t | t | t | t | m |
| 17 | 77,0 | 79,0 | 85,5 | 102,0 | 108,0 | 116,0 | 128,0 | 73,0 | 75,5 | 81,0 | 97,0 | 102,0 | 109,0 | 121,0 | 17 | | | | | | | | |
| 18 | 75,5 | 79,0 | 85,0 | 102,0 | 108,0 | 116,0 | 128,0 | 72,5 | 75,0 | 80,5 | 97,0 | 101,0 | 109,0 | 121,0 | 18 | | | | | | | | |
| 20 | 67,0 | 78,5 | 85,0 | 102,0 | 108,0 | 116,0 | 127,0 | 65,0 | 74,5 | 80,5 | 96,5 | 101,0 | 109,0 | 121,0 | 20 | | | | | | | | |
| 22 | 59,5 | 78,0 | 84,5 | 102,0 | 108,0 | 116,0 | 127,0 | 57,5 | 74,5 | 80,0 | 96,5 | 101,0 | 108,0 | 121,0 | 22 | | | | | | | | |
| 24 | 52,5 | 78,0 | 84,0 | 101,0 | 108,0 | 116,0 | 127,0 | 51,0 | 74,0 | 79,5 | 96,0 | 101,0 | 108,0 | 120,0 | 24 | | | | | | | | |
| 26 | 47,1 | 77,5 | 84,0 | 100,0 | 107,0 | 116,0 | 126,5 | 45,5 | 73,5 | 79,5 | 95,5 | 100,0 | 107,0 | 119,5 | 26 | | | | | | | | |
| 28 | 41,8 | 77,0 | 83,5 | 99,5 | 106,0 | 115,0 | 126,0 | 40,3 | 73,5 | 79,0 | 95,5 | 99,5 | 107,0 | 119,0 | 28 | | | | | | | | |
| 30 | 37,2 | 76,5 | 83,5 | 98,5 | 104,0 | 115,0 | 125,0 | 35,7 | 73,0 | 79,0 | 95,0 | 98,5 | 106,0 | 118,5 | 30 | | | | | | | | |
| 34 | 29,6 | 75,5 | 82,5 | 96,5 | 102,0 | 113,0 | 124,0 | 28,1 | 72,0 | 78,0 | 93,6 | 96,8 | 104,0 | 117,5 | 34 | | | | | | | | |
| 38 | 22,8 | 74,6 | 81,6 | 94,1 | 99,5 | 110,6 | 122,0 | 21,5 | 71,1 | 77,1 | 91,8 | 94,6 | 101,8 | 116,0 | 38 | | | | | | | | |
| 42 | 17,0 | 74,0 | 81,0 | 91,5 | 96,5 | 108,0 | 119,3 | 15,7 | 70,5 | 76,5 | 89,5 | 92,0 | 99,5 | 113,6 | 42 | | | | | | | | |
| 46 | 12,4 | 72,6 | 79,3 | 88,3 | 92,6 | 103,8 | 116,0 | 11,1 | 69,5 | 75,1 | 87,1 | 89,0 | 95,8 | 111,0 | 46 | | | | | | | | |
| 50 | 8,3 | 71,2 | 78,0 | 84,8 | 89,5 | 99,8 | 112,6 | 7,0 | 68,3 | 74,0 | 84,3 | 85,6 | 92,0 | 107,6 | 50 | | | | | | | | |
| 53 | 5,6 | 70,2 | 76,8 | 82,7 | 87,2 | 97,6 | 110,0 | 4,3 | 67,3 | 72,8 | 82,5 | 83,6 | 89,7 | 104,5 | 53 | | | | | | | | |
| 54 | 4,7 | 70,0 | 76,5 | 82,0 | 86,5 | 97,0 | 109,0 | - | 67,0 | 72,5 | 82,0 | 83,0 | 89,0 | 103,1 | 54 | | | | | | | | |
| 58 | - | 68,3 | 75,1 | 78,5 | 82,5 | 94,0 | 100,0 | - | 65,6 | 71,1 | 78,8 | 79,5 | 85,0 | 97,5 | 58 | | | | | | | | |
| 62 | - | 66,8 | 73,8 | 75,3 | 78,8 | 90,0 | 92,6 | - | 64,3 | 69,8 | 75,8 | 76,1 | 81,6 | 90,1 | 62 | | | | | | | | |
| 66 | - | 65,5 | 72,5 | 72,0 | 75,5 | 87,0 | 85,5 | - | 63,0 | 68,5 | 73,5 | 73,5 | 78,0 | 83,0 | 66 | | | | | | | | |
| 70 | - | 63,3 | 71,1 | 68,6 | 72,1 | 80,6 | 78,5 | - | 61,6 | 67,1 | 70,6 | 70,3 | 75,0 | 76,0 | 70 | | | | | | | | |
| 74 | - | 61,1 | 68,3 | 64,5 | 67,5 | 74,5 | 72,1 | - | 59,7 | 65,5 | 67,0 | 66,5 | 69,5 | 69,5 | 74 | | | | | | | | |
| 78 | - | 59,5 | 63,5 | 59,5 | 62,5 | 68,0 | 66,0 | - | 57,5 | 61,5 | 62,0 | 61,0 | 61,5 | 63,6 | 78 | | | | | | | | |
| 82 | - | 57,5 | 58,5 | 54,1 | 57,5 | 62,3 | 60,0 | - | 55,5 | 56,5 | 57,0 | 55,6 | 53,8 | 58,0 | 82 | | | | | | | | |
| 86 | - | 54,8 | 53,7 | 49,0 | 52,4 | 56,3 | 54,6 | - | 53,0 | 51,8 | 52,1 | 50,3 | 46,8 | 52,6 | 86 | | | | | | | | |
| 90 | - | 51,5 | 49,3 | 44,2 | 47,4 | 50,0 | 49,7 | - | 50,0 | 47,6 | 47,5 | 45,1 | 40,3 | 47,8 | 90 | | | | | | | | |
| 94 | - | 47,5 | 44,9 | 39,2 | 42,4 | 44,6 | 45,3 | - | 45,9 | 43,3 | 42,6 | 39,7 | 33,9 | 43,4 | 94 | | | | | | | | |
| 98 | - | 43,4 | 40,8 | 34,2 | 37,3 | 39,2 | 41,1 | - | 41,9 | 39,2 | 37,6 | 34,5 | 28,1 | 39,2 | 98 | | | | | | | | |
| 102 | - | 39,4 | 36,9 | 29,3 | 32,3 | 34,0 | 37,3 | - | 37,9 | 35,3 | 32,6 | 29,3 | 22,7 | 35,4 | 102 | | | | | | | | |
| 106 | - | 36,1 | 33,5 | 24,8 | 27,6 | 29,4 | 33,8 | - | 34,5 | 31,9 | 27,5 | 24,8 | 18,0 | 31,9 | 106 | | | | | | | | |
| 110 | - | 32,4 | 30,3 | 20,5 | 23,2 | 25,2 | 30,4 | - | 30,9 | 28,8 | 22,9 | 20,6 | 13,9 | 28,6 | 110 | | | | | | | | |
| 114 | - | 28,2 | 27,1 | 16,6 | 19,2 | 21,3 | 27,1 | - | 25,8 | 25,8 | 18,5 | 16,6 | 10,1 | 25,5 | 114 | | | | | | | | |
| 118 | - | 23,4 | 22,2 | 13,1 | 15,6 | 17,9 | 23,9 | - | 20,7 | 20,8 | 14,6 | 13,0 | 6,8 | 22,6 | 118 | | | | | | | | |
| 122 | - | 19,0 | 17,7 | 9,8 | 12,2 | 14,9 | 20,7 | - | 16,5 | 16,3 | 11,0 | 9,7 | 4,1 | 19,8 | 122 | | | | | | | | |
| 126 | - | 15,5 | 14,3 | 7,0 | 9,3 | 12,2 | 17,8 | - | 12,5 | 12,6 | 7,8 | 6,7 | - | 17,2 | 126 | | | | | | | | |
| 130 | - | 12,1 | 11,2 | 4,4 | 6,7 | 10,0 | 15,2 | - | 9,1 | 9,4 | 5,0 | 4,1 | - | 14,6 | 130 | | | | | | | | |
| 131 | - | 11,2 | 10,4 | - | 6,1 | 9,5 | 14,6 | - | 8,3 | 8,6 | 4,3 | - | - | 14,0 | 131 | | | | | | | | |
| 134 | - | 9,0 | 8,5 | - | 4,4 | 8,2 | 12,9 | - | 6,4 | 6,6 | - | - | - | 12,2 | 134 | | | | | | | | |
| 137 | - | 6,9 | 6,8 | - | - | 7,1 | 11,4 | - | 4,9 | 4,8 | - | - | - | 10,5 | 137 | | | | | | | | |
| 138 | - | - | - | - | - | - | - | - | 4,4 | 4,3 | - | - | - | 10,0 | 138 | | | | | | | | |
| 140 | - | - | - | - | - | - | - | - | - | - | - | - | - | 9,0 | 140 | | | | | | | | |

| | | | | | | | | |
|--|-----|------|-------|-------|-------|-------|-------|-------|
| | 0 t | 65 t | 125 t | 165 t | 205 t | 245 t | 285 t | 325 t |
|--|-----|------|-------|-------|-------|-------|-------|-------|

LSL_15: 225 t + 50 t

| 165 t + 50 t | | 11-19 m | | | | 8,40 m | | | | 9.8 m/s | | | | 360° | | | | ISO |
|--------------|------|---------|------|--------|-------|--------|------|---------|------|---------|------|--------|-------|---------|------|------|-----|-----|
| 162 m | | 165 m | | | | 168 m | | | | 171 m | | | | | | | | |
| LSL_9 | | LSL_11 | | LSL_13 | | LSL_15 | | LSL_9 | | LSL_11 | | LSL_13 | | LSL_15 | | | | |
| 0 t | | 0t-325t | | | | 0 t | | 0t-325t | | | | 0 t | | 0t-325t | | | | |
| m | t | t | t | t | t | t | t | t | t | t | t | t | t | t | t | t | m | |
| 18 | 70,5 | 91,5 | 96,0 | 104,0 | 115,0 | 68,5 | 86,0 | 90,5 | 98,0 | 109,0 | 65,5 | 92,0 | 104,0 | 63,5 | 87,0 | 97,5 | 18 | |
| 20 | 61,5 | 91,0 | 95,5 | 103,0 | 115,0 | 59,5 | 85,5 | 90,5 | 98,0 | 109,0 | 57,0 | 91,5 | 104,0 | 55,0 | 86,5 | 97,5 | 20 | |
| 22 | 54,0 | 90,5 | 95,5 | 103,0 | 114,0 | 52,0 | 85,0 | 90,0 | 97,5 | 108,0 | 49,9 | 91,5 | 103,0 | 47,9 | 86,0 | 97,0 | 22 | |
| 24 | 47,8 | 90,5 | 95,5 | 103,0 | 114,0 | 45,9 | 85,0 | 90,0 | 97,5 | 108,0 | 43,5 | 91,5 | 103,0 | 41,5 | 86,0 | 96,5 | 24 | |
| 26 | 41,9 | 90,0 | 95,0 | 103,0 | 113,5 | 40,1 | 84,5 | 90,0 | 97,5 | 107,5 | 37,7 | 91,0 | 102,5 | 35,8 | 86,0 | 96,2 | 26 | |
| 28 | 36,6 | 90,0 | 94,5 | 102,0 | 113,0 | 34,9 | 84,5 | 89,5 | 97,0 | 107,0 | 32,6 | 90,5 | 102,0 | 30,8 | 85,5 | 96,0 | 28 | |
| 30 | 32,0 | 89,5 | 94,0 | 102,0 | 112,5 | 30,3 | 84,0 | 89,0 | 96,5 | 106,5 | 28,0 | 90,5 | 101,5 | 26,2 | 85,0 | 95,2 | 30 | |
| 34 | 24,2 | 88,5 | 92,6 | 100,3 | 111,5 | 22,7 | 83,3 | 88,3 | 95,8 | 105,5 | 20,4 | 90,1 | 100,5 | 18,7 | 84,6 | 94,2 | 34 | |
| 38 | 17,4 | 87,1 | 90,8 | 98,5 | 110,0 | 15,9 | 82,5 | 87,1 | 94,8 | 104,0 | 13,7 | 89,3 | 99,5 | 12,1 | 84,0 | 93,2 | 38 | |
| 42 | 11,6 | 85,5 | 88,5 | 96,5 | 108,0 | 10,1 | 81,5 | 85,5 | 93,5 | 102,0 | 8,0 | 88,0 | 98,1 | 6,4 | 83,0 | 91,8 | 42 | |
| 43 | 10,4 | 85,0 | 88,0 | 95,7 | 107,5 | 8,9 | 81,1 | 85,0 | 93,0 | 101,5 | 6,8 | 87,5 | 97,7 | 5,1 | 82,5 | 91,5 | 43 | |
| 45 | 8,1 | 84,0 | 87,0 | 94,2 | 106,5 | 6,5 | 80,3 | 83,8 | 91,8 | 100,5 | 4,4 | 86,5 | 96,9 | - | 81,7 | 90,8 | 45 | |
| 46 | 7,0 | 83,5 | 86,0 | 93,5 | 106,0 | 5,3 | 80,0 | 83,2 | 91,2 | 100,0 | - | 86,0 | 96,5 | - | 81,3 | 90,5 | 46 | |
| 47 | 5,8 | 83,0 | 85,2 | 92,7 | 105,2 | 4,2 | 79,7 | 82,6 | 90,6 | 99,5 | - | 85,5 | 96,0 | - | 80,9 | 90,0 | 47 | |
| 48 | 4,7 | 82,5 | 84,5 | 92,0 | 104,4 | - | 79,5 | 82,0 | 90,0 | 99,0 | - | 85,0 | 95,5 | - | 80,5 | 89,4 | 48 | |
| 50 | - | 81,3 | 83,1 | 90,1 | 102,8 | - | 78,5 | 80,8 | 88,5 | 98,0 | - | 83,6 | 94,3 | - | 79,5 | 88,2 | 50 | |
| 54 | - | 79,0 | 80,5 | 87,5 | 99,0 | - | 76,5 | 78,5 | 86,0 | 94,8 | - | 81,5 | 91,6 | - | 77,5 | 85,6 | 54 | |
| 58 | - | 77,0 | 78,1 | 83,8 | 95,0 | - | 75,1 | 76,5 | 83,6 | 91,5 | - | 79,3 | 89,0 | - | 75,5 | 83,0 | 58 | |
| 62 | - | 74,5 | 75,3 | 80,3 | 88,0 | - | 73,6 | 74,0 | 81,5 | 84,8 | - | 77,5 | 82,6 | - | 73,6 | 78,3 | 62 | |
| 66 | - | 72,5 | 73,0 | 77,5 | 81,1 | - | 72,0 | 72,0 | 79,5 | 78,2 | - | 75,5 | 76,5 | - | 72,0 | 73,0 | 66 | |
| 70 | - | 69,6 | 69,8 | 74,7 | 74,5 | - | 70,5 | 69,5 | 74,0 | 72,0 | - | 72,6 | 70,5 | - | 69,1 | 67,0 | 70 | |
| 74 | - | 66,5 | 66,3 | 70,0 | 68,2 | - | 67,5 | 66,1 | 68,0 | 66,0 | - | 67,1 | 64,8 | - | 64,8 | 61,6 | 74 | |
| 78 | - | 62,5 | 62,0 | 64,0 | 62,3 | - | 62,5 | 62,5 | 62,0 | 60,1 | - | 61,5 | 59,1 | - | 59,5 | 56,3 | 78 | |
| 82 | - | 57,8 | 56,6 | 56,3 | 57,0 | - | 57,5 | 57,1 | 56,6 | 54,5 | - | 56,5 | 53,5 | - | 54,5 | 51,0 | 82 | |
| 86 | - | 53,1 | 51,5 | 49,2 | 51,8 | - | 52,6 | 51,9 | 51,6 | 49,8 | - | 51,6 | 48,8 | - | 49,4 | 46,5 | 86 | |
| 90 | - | 48,3 | 46,7 | 42,7 | 47,0 | - | 47,9 | 46,7 | 46,9 | 45,1 | - | 46,9 | 44,2 | - | 45,0 | 42,1 | 90 | |
| 94 | - | 43,6 | 41,5 | 36,6 | 42,4 | - | 43,6 | 41,3 | 41,1 | 40,5 | - | 42,6 | 39,8 | - | 40,6 | 37,7 | 94 | |
| 98 | - | 38,8 | 36,3 | 30,9 | 38,2 | - | 39,5 | 36,0 | 35,3 | 36,3 | - | 38,6 | 35,6 | - | 36,5 | 33,6 | 98 | |
| 102 | - | 34,0 | 31,1 | 25,5 | 34,4 | - | 35,7 | 30,6 | 29,7 | 32,5 | - | 34,4 | 31,6 | - | 32,9 | 29,9 | 102 | |
| 106 | - | 28,7 | 26,3 | 20,7 | 30,8 | - | 32,1 | 25,7 | 24,7 | 28,9 | - | 29,7 | 27,8 | - | 29,4 | 26,3 | 106 | |
| 110 | - | 23,8 | 21,8 | 16,3 | 27,6 | - | 27,9 | 21,1 | 19,9 | 25,7 | - | 25,2 | 23,8 | - | 25,8 | 22,7 | 110 | |
| 114 | - | 19,2 | 17,6 | 12,3 | 24,5 | - | 22,9 | 16,8 | 15,6 | 22,7 | - | 21,1 | 20,2 | - | 21,8 | 19,1 | 114 | |
| 118 | - | 15,0 | 13,7 | 8,8 | 21,4 | - | 18,3 | 12,9 | 11,8 | 19,8 | - | 17,2 | 16,6 | - | 18,0 | 15,5 | 118 | |
| 122 | - | 11,3 | 10,2 | 5,8 | 18,1 | - | 14,1 | 9,3 | 8,3 | 17,0 | - | 13,5 | 13,4 | - | 14,3 | 12,3 | 122 | |
| 124 | - | 9,5 | 8,5 | 4,4 | 16,5 | - | 12,2 | 7,6 | 6,8 | 15,8 | - | 11,8 | 11,8 | - | 12,5 | 10,7 | 124 | |
| 126 | - | 7,8 | 6,9 | - | 15,0 | - | 10,3 | 5,9 | 5,6 | 14,3 | - | 10,2 | 10,4 | - | 10,8 | 9,2 | 126 | |
| 128 | - | 6,2 | 5,4 | - | 13,6 | - | 8,5 | 4,4 | 4,3 | 12,9 | - | 8,6 | 9,0 | - | 9,2 | 7,8 | 128 | |
| 130 | - | 4,7 | 4,0 | - | 12,3 | - | 6,9 | - | - | 11,5 | - | 7,1 | 7,6 | - | 7,6 | 6,4 | 130 | |
| 133 | - | - | - | - | 10,4 | - | 4,6 | - | - | 9,5 | - | 4,9 | 5,7 | - | 5,3 | 4,4 | 133 | |
| 134 | - | - | - | - | 9,8 | - | - | - | - | 8,9 | - | 4,3 | 5,0 | - | 4,7 | - | 134 | |
| 135 | - | - | - | - | 9,2 | - | - | - | - | 8,3 | - | - | 4,4 | - | - | - | 135 | |
| 138 | - | - | - | - | 7,5 | - | - | - | - | 6,6 | - | - | - | - | - | - | 138 | |
| 142 | - | - | - | - | 5,5 | - | - | - | - | 4,4 | - | - | - | - | - | - | 142 | |



LSL_15: 225 t + 50 t

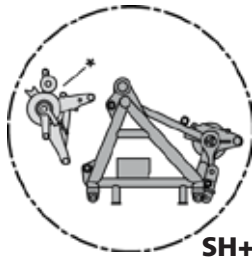

SH+LH_1

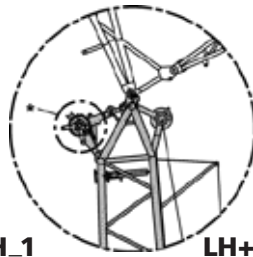

LH+LF_1

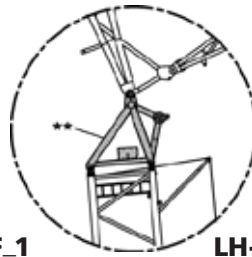

LH+LF_3
LH+LF_4

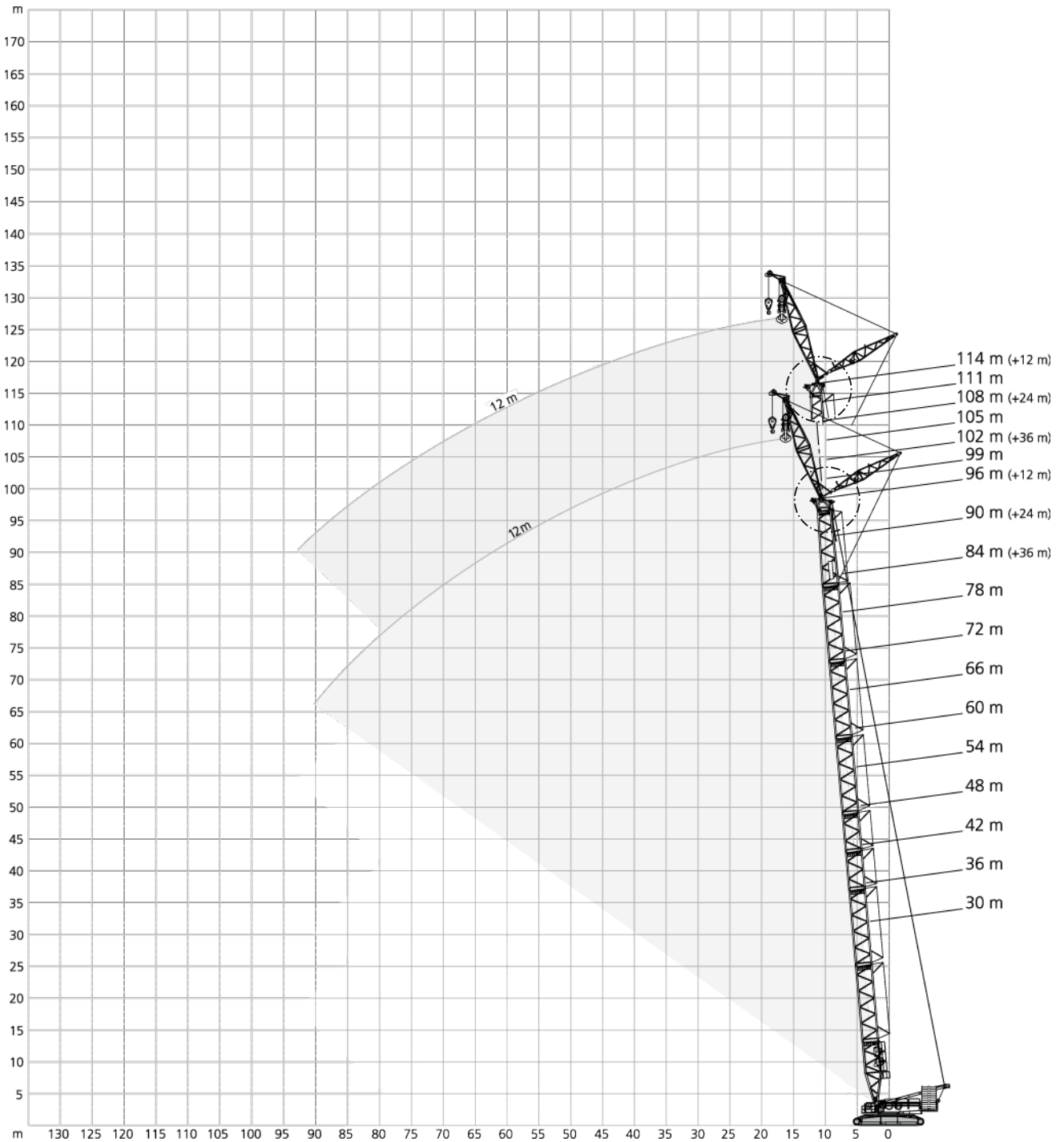

* Attachable · Anbaubar · Amovible · Montabile · Acoplable · Adaptável · Приставн

** Option · Option · En option · Opzione · Orcion · Orcional · Опция

| | | 12-36 m | | | | | | | | | 8,40 m | | | 9.8 m/s | | | 360° | | | ISO | |
|----|-------|---------|------|------|------|------|------|------|------|-----|--------|-----|-----|---------|-----|-----|------|-----|-----|-----|--|
| | | 30 m | | | | | | | | | 36 m | | | | | | | | | | |
| | | SH+LF_1 | | | | | | | | | | | | | | | | | | | |
| | | 12 m | | | 24 m | | | 36 m | | | 12 m | | | 24 m | | | 36 m | | | | |
| | | 15° | 20° | 30° | 15° | 20° | 30° | 15° | 20° | 30° | 15° | 20° | 30° | 15° | 20° | 30° | 15° | 20° | 30° | | |
| m | t | t | t | t | t | t | t | t | t | t | t | t | t | t | t | t | t | t | t | m | |
| 9 | 171,0 | - | - | - | - | - | - | - | - | - | - | - | - | - | - | - | - | - | - | 9 | |
| 10 | 160,0 | - | - | - | - | - | - | - | - | - | - | - | - | - | - | - | - | - | - | 10 | |
| 11 | 150,5 | 119,0 | - | - | - | - | - | - | - | - | - | - | - | - | - | - | - | - | - | 11 | |
| 12 | 141,0 | 113,0 | 77,0 | - | - | - | - | - | - | - | - | - | - | - | - | - | - | - | - | 12 | |
| 13 | 133,5 | 108,0 | 74,2 | - | - | - | - | - | - | - | - | - | - | - | - | - | - | - | - | 13 | |
| 14 | 126,0 | 103,0 | 71,5 | 78,5 | - | - | - | - | - | - | - | - | - | - | - | - | - | - | - | 14 | |
| 16 | 114,0 | 95,0 | 67,0 | 71,0 | 57,5 | - | - | - | - | - | - | - | - | - | - | - | - | - | - | 16 | |
| 18 | 105,0 | 87,5 | 63,0 | 64,5 | 53,0 | - | 50,5 | - | - | - | - | - | - | - | - | - | - | - | - | 18 | |
| 19 | 101,0 | 84,7 | 61,5 | 61,7 | 51,2 | 36,1 | 48,4 | - | - | - | - | - | - | - | - | - | - | - | - | 19 | |
| 20 | 97,0 | 82,0 | 60,0 | 59,0 | 49,4 | 35,0 | 46,4 | - | - | - | - | - | - | - | - | - | - | - | - | 20 | |
| 21 | 93,5 | 79,2 | 58,5 | 56,7 | 47,7 | 34,0 | 44,6 | 36,9 | - | - | - | - | - | - | - | - | - | - | - | 21 | |
| 22 | 90,0 | 76,5 | 57,0 | 54,5 | 46,0 | 33,0 | 42,9 | 35,6 | - | - | - | - | - | - | - | - | - | - | - | 22 | |
| 24 | 84,0 | 72,0 | 54,5 | 50,5 | 43,0 | 31,2 | 39,7 | 33,1 | - | - | - | - | - | - | - | - | - | - | - | 24 | |
| 26 | 78,5 | 68,5 | 52,0 | 47,5 | 40,4 | 29,6 | 36,8 | 31,0 | 22,0 | - | - | - | - | - | - | - | - | - | - | 26 | |
| 27 | 76,5 | 66,7 | 51,0 | 46,0 | 39,2 | 28,9 | 35,6 | 30,0 | 21,4 | - | - | - | - | - | - | - | - | - | - | 27 | |
| 28 | 74,5 | 65,0 | 50,0 | 44,5 | 38,1 | 28,2 | 34,4 | 29,0 | 20,8 | - | - | - | - | - | - | - | - | - | - | 28 | |
| 30 | 70,5 | 62,0 | 48,6 | 41,9 | 36,1 | 26,9 | 32,2 | 27,3 | 19,7 | - | - | - | - | - | - | - | - | - | - | 30 | |
| 34 | 64,0 | 57,0 | 45,9 | 37,5 | 32,7 | 24,8 | 28,5 | 24,4 | 17,8 | - | - | - | - | - | - | - | - | - | - | 34 | |
| 38 | 57,0 | 53,5 | - | 34,0 | 29,9 | 23,0 | 25,6 | 22,1 | 16,2 | - | - | - | - | - | - | - | - | - | - | 38 | |
| 39 | 55,0 | - | - | 33,2 | 29,3 | 22,6 | 25,0 | 21,6 | 15,9 | - | - | - | - | - | - | - | - | - | - | 39 | |
| 40 | 53,0 | - | - | 32,5 | 28,7 | 22,3 | 24,4 | 21,1 | 15,6 | - | - | - | - | - | - | - | - | - | - | 40 | |
| 42 | - | - | - | 31,1 | 27,6 | 21,6 | 23,2 | 20,1 | 15,0 | - | - | - | - | - | - | - | - | - | - | 42 | |
| 43 | - | - | - | 30,5 | 27,1 | 21,3 | 22,6 | 19,7 | 14,7 | - | - | - | - | - | - | - | - | - | - | 43 | |
| 45 | - | - | - | 29,3 | 26,2 | 20,8 | 21,6 | 18,9 | 14,1 | - | - | - | - | - | - | - | - | - | - | 45 | |
| 46 | - | - | - | 28,8 | 25,8 | 20,6 | 21,1 | 18,5 | 13,9 | - | - | - | - | - | - | - | - | - | - | 46 | |
| 50 | - | - | - | 27,0 | 24,4 | - | 19,4 | 17,1 | 13,0 | - | - | - | - | - | - | - | - | - | - | 50 | |
| 51 | - | - | - | 26,6 | - | - | 19,0 | 16,8 | 12,8 | - | - | - | - | - | - | - | - | - | - | 51 | |
| 54 | - | - | - | - | - | - | 18,0 | 15,9 | 12,2 | - | - | - | - | - | - | - | - | - | - | 54 | |
| 56 | - | - | - | - | - | - | 17,4 | 15,4 | 11,9 | - | - | - | - | - | - | - | - | - | - | 56 | |
| 58 | - | - | - | - | - | - | 16,8 | 15,0 | 11,7 | - | - | - | - | - | - | - | - | - | - | 58 | |
| 61 | - | - | - | - | - | - | 16,1 | 14,4 | - | - | - | - | - | - | - | - | - | - | - | 61 | |
| 62 | - | - | - | - | - | - | 15,9 | - | - | - | - | - | - | - | - | - | - | - | - | 62 | |
| 63 | - | - | - | - | - | - | 15,7 | - | - | - | - | - | - | - | - | - | - | - | - | 63 | |
| 66 | - | - | - | - | - | - | - | - | - | - | - | - | - | - | - | - | - | - | - | 66 | |
| 68 | - | - | - | - | - | - | - | - | - | - | - | - | - | - | - | - | - | - | - | 68 | |

45t 85t 125t 165t 185t 205t
 0t 30t 50t

| | | 12-36 m | | | | | | 8,40 m | | | 9.8 m/s | | | 360° | | | ISO | | | |
|----|-------|---------|------|------|------|------|------|--------|------|-------|---------|------|------|------|------|------|------|------|-----|----|
| | | 48 m | | | | | | | | | 54 m | | | | | | | | | |
| | | SH+LF_1 | | | | | | | | | | | | | | | | | | |
| | | 12 m | | | 24 m | | | 36 m | | | 12 m | | | 24 m | | | 36 m | | | |
| | | 15° | 20° | 30° | 15° | 20° | 30° | 15° | 20° | 30° | 15° | 20° | 30° | 15° | 20° | 30° | 15° | 20° | 30° | |
| m | t | t | t | t | t | t | t | t | t | t | t | t | t | t | t | t | t | t | t | m |
| 11 | 167,0 | - | - | - | - | - | - | - | - | 163,0 | - | - | - | - | - | - | - | - | - | 11 |
| 12 | 159,0 | 122,0 | - | - | - | - | - | - | - | - | - | - | - | - | - | - | - | - | - | 12 |
| 13 | 152,5 | 118,0 | - | - | - | - | - | - | - | 156,5 | 120,0 | - | - | - | - | - | - | - | - | 13 |
| 14 | 146,0 | 114,0 | 75,5 | - | - | - | - | - | - | 150,0 | 117,0 | 76,5 | - | - | - | - | - | - | - | 14 |
| 15 | 140,0 | 110,0 | 73,7 | 81,0 | - | - | - | - | - | 144,5 | 113,0 | 74,7 | - | - | - | - | - | - | - | 15 |
| 16 | 134,0 | 106,0 | 72,0 | 78,0 | - | - | - | - | - | 139,0 | 109,0 | 73,0 | 79,5 | - | - | - | - | - | - | 16 |
| 17 | 129,0 | 103,0 | 70,2 | 75,0 | 59,0 | - | - | - | - | 134,5 | 106,0 | 71,5 | 76,7 | - | - | - | - | - | - | 17 |
| 18 | 124,0 | 100,0 | 68,5 | 72,0 | 57,0 | - | - | - | - | 130,0 | 103,0 | 70,0 | 74,0 | 58,0 | - | - | - | - | - | 18 |
| 19 | 120,0 | 97,2 | 67,0 | 69,5 | 55,2 | - | 50,5 | - | - | 125,5 | 100,5 | 68,5 | 71,5 | 56,2 | - | - | - | - | - | 19 |
| 20 | 116,0 | 94,5 | 65,5 | 67,0 | 53,5 | - | 49,0 | - | - | 121,0 | 98,0 | 67,0 | 69,0 | 54,5 | - | 49,6 | - | - | - | 20 |
| 21 | 112,5 | 92,0 | 64,2 | 64,7 | 52,0 | 35,4 | 47,4 | - | - | 117,5 | 95,5 | 65,7 | 66,7 | 53,0 | 35,7 | 48,0 | - | - | - | 21 |
| 22 | 109,0 | 89,5 | 63,0 | 62,5 | 50,5 | 34,6 | 45,8 | 37,2 | - | 114,0 | 93,0 | 64,5 | 64,5 | 51,5 | 34,9 | 46,5 | - | - | - | 22 |
| 23 | 105,5 | 87,2 | 61,7 | 60,5 | 49,2 | 33,8 | 44,4 | 36,2 | - | 108,5 | 90,7 | 63,2 | 62,5 | 50,4 | 34,2 | 45,1 | 36,5 | - | - | 23 |
| 24 | 102,0 | 85,0 | 60,5 | 58,5 | 48,0 | 33,1 | 43,0 | 35,2 | - | 103,0 | 88,5 | 62,0 | 60,5 | 49,3 | 33,5 | 43,8 | 35,5 | - | - | 24 |
| 26 | 92,5 | 81,0 | 58,5 | 55,0 | 45,5 | 31,7 | 40,6 | 33,3 | - | 91,5 | 84,5 | 60,0 | 57,5 | 46,9 | 32,2 | 41,4 | 33,7 | - | - | 26 |
| 28 | 83,0 | 77,5 | 56,5 | 52,0 | 43,3 | 30,5 | 38,3 | 31,6 | 21,5 | 82,0 | 81,0 | 58,0 | 54,5 | 44,7 | 31,0 | 39,2 | 32,1 | 21,6 | - | 28 |
| 30 | 75,0 | 74,0 | 54,5 | 49,6 | 41,3 | 29,3 | 36,2 | 30,1 | 20,6 | 74,0 | 74,5 | 56,5 | 51,5 | 42,7 | 29,9 | 37,2 | 30,7 | 20,7 | - | 30 |
| 34 | 62,5 | 63,0 | 51,5 | 44,9 | 37,8 | 27,3 | 32,5 | 27,3 | 19,0 | 61,5 | 61,5 | 53,0 | 47,0 | 39,2 | 27,9 | 33,6 | 28,1 | 19,2 | - | 34 |
| 38 | 53,0 | 53,0 | 49,1 | 41,0 | 34,9 | 25,6 | 29,4 | 25,0 | 17,6 | 51,5 | 52,0 | 50,5 | 43,1 | 36,3 | 26,3 | 30,5 | 25,8 | 17,9 | - | 38 |
| 42 | 45,3 | 45,6 | 46,0 | 37,8 | 32,5 | 24,1 | 27,0 | 23,0 | 16,4 | 44,0 | 44,4 | 44,9 | 39,7 | 33,8 | 24,8 | 28,0 | 23,8 | 16,7 | - | 42 |
| 46 | 39,2 | 39,4 | 39,7 | 35,1 | 30,4 | 22,9 | 25,1 | 21,3 | 15,3 | 37,9 | 38,1 | 38,6 | 36,9 | 31,7 | 23,6 | 26,0 | 22,1 | 15,7 | - | 46 |
| 47 | 37,8 | 38,0 | 38,4 | 34,5 | 29,9 | 22,6 | 24,6 | 20,9 | 15,0 | 36,6 | 36,8 | 37,3 | 36,3 | 31,2 | 23,3 | 25,6 | 21,7 | 15,4 | - | 47 |
| 50 | 34,2 | 34,3 | - | 32,7 | 28,6 | 21,9 | 23,2 | 19,9 | 14,4 | 32,8 | 33,0 | 33,4 | 34,5 | 29,9 | 22,5 | 24,4 | 20,7 | 14,8 | - | 50 |
| 51 | 33,1 | 33,2 | - | 32,2 | 28,2 | 21,6 | 22,8 | 19,5 | 14,2 | 31,7 | 31,9 | 32,2 | 33,6 | 29,5 | 22,2 | 23,9 | 20,3 | 14,6 | - | 51 |
| 53 | 31,0 | 31,1 | - | 31,2 | 27,4 | 21,2 | 22,0 | 18,9 | 13,8 | 29,5 | 29,7 | - | 31,9 | 28,7 | 21,8 | 23,1 | 19,7 | 14,2 | - | 53 |
| 54 | 30,0 | - | - | 30,8 | 27,1 | 21,0 | 21,6 | 18,6 | 13,6 | 28,4 | 28,6 | - | 31,1 | 28,3 | 21,6 | 22,7 | 19,4 | 14,0 | - | 54 |
| 55 | 29,0 | - | - | 30,2 | 26,7 | 20,8 | 21,2 | 18,3 | 13,4 | 27,4 | 27,6 | - | 30,1 | 27,9 | 21,4 | 22,3 | 19,1 | 13,8 | - | 55 |
| 58 | - | - | - | 28,6 | 25,8 | 20,3 | 20,2 | 17,5 | 13,0 | 24,6 | 24,7 | - | 27,4 | 26,9 | 20,9 | 21,3 | 18,2 | 13,3 | - | 58 |
| 59 | - | - | - | 27,8 | 25,5 | 20,2 | 19,9 | 17,2 | 12,8 | 23,7 | - | - | 26,5 | 26,2 | 20,7 | 20,9 | 17,9 | 13,1 | - | 59 |
| 60 | - | - | - | 27,0 | 25,3 | - | 19,6 | 17,0 | 12,7 | 22,9 | - | - | 25,7 | 25,6 | 20,6 | 20,6 | 17,7 | 13,0 | - | 60 |
| 62 | - | - | - | 25,4 | 24,8 | - | 19,0 | 16,5 | 12,4 | - | - | - | 24,0 | 24,3 | 20,3 | 20,0 | 17,2 | 12,7 | - | 62 |
| 63 | - | - | - | 24,6 | 24,4 | - | 18,7 | 16,3 | 12,2 | - | - | - | 23,2 | 23,5 | 20,1 | 19,7 | 17,0 | 12,5 | - | 63 |
| 64 | - | - | - | 23,9 | 24,1 | - | 18,4 | 16,1 | 12,1 | - | - | - | 22,5 | 22,7 | - | 19,4 | 16,8 | 12,4 | - | 64 |
| 66 | - | - | - | 22,5 | - | - | 17,9 | 15,7 | 11,9 | - | - | - | 21,0 | 21,3 | - | 18,9 | 16,4 | 12,2 | - | 66 |
| 67 | - | - | - | 21,8 | - | - | 17,6 | 15,5 | 11,8 | - | - | - | 20,3 | 20,6 | - | 18,6 | 16,2 | 12,1 | - | 67 |
| 69 | - | - | - | - | - | - | 17,2 | 15,1 | 11,6 | - | - | - | 19,0 | 19,2 | - | 18,1 | 15,8 | 11,9 | - | 69 |
| 70 | - | - | - | - | - | - | 17,0 | 15,0 | 11,5 | - | - | - | 18,4 | - | - | 17,9 | 15,6 | 11,8 | - | 70 |
| 72 | - | - | - | - | - | - | 16,6 | 14,7 | - | - | - | - | 17,2 | - | - | 17,4 | 15,3 | 11,6 | - | 72 |
| 74 | - | - | - | - | - | - | 16,2 | 14,4 | - | - | - | - | - | - | - | 17,0 | 15,0 | 11,5 | - | 74 |
| 76 | - | - | - | - | - | - | 15,9 | 14,2 | - | - | - | - | - | - | - | 16,3 | 14,7 | - | - | 76 |
| 78 | - | - | - | - | - | - | 15,6 | - | - | - | - | - | - | - | - | 15,7 | 14,4 | - | - | 78 |
| 81 | - | - | - | - | - | - | - | - | - | - | - | - | - | - | - | 14,2 | 14,1 | - | - | 81 |
| 82 | - | - | - | - | - | - | - | - | - | - | - | - | - | - | - | 13,8 | - | - | - | 82 |
| 83 | - | - | - | - | - | - | - | - | - | - | - | - | - | - | - | 13,4 | - | - | - | 83 |



| | | 12-36 m | | | | | | 8,40 m | | | 9.8 m/s | | | 360° | | | ISO | | |
|----|-------|---------|------|------|------|------|------|---------|------|------|---------|-------|------|------|------|------|------|------|-----|
| | | 60 m | | | | | | SH+LF_1 | | | | | | | | | 66 m | | |
| | | 12 m | | 24 m | | 36 m | | 12 m | | 24 m | | 36 m | | | | | | | |
| | | 15° | 20° | 30° | 15° | 20° | 30° | 15° | 20° | 30° | 15° | 20° | 30° | 15° | 20° | 30° | 15° | 20° | 30° |
| m | t | t | t | t | t | t | t | t | t | t | t | t | t | t | t | t | t | t | m |
| 12 | 167,0 | - | - | - | - | - | - | - | - | - | - | - | - | - | - | - | - | - | 12 |
| 13 | 161,0 | 123,0 | - | - | - | - | - | - | - | - | 164,0 | - | - | - | - | - | - | - | 13 |
| 14 | 155,0 | 119,0 | - | - | - | - | - | - | - | - | 158,0 | 121,0 | - | - | - | - | - | - | 14 |
| 15 | 149,5 | 115,5 | 75,5 | - | - | - | - | - | - | - | 153,0 | 117,5 | - | - | - | - | - | - | 15 |
| 16 | 144,0 | 112,0 | 73,5 | 81,0 | - | - | - | - | - | - | 148,0 | 114,0 | 74,5 | - | - | - | - | - | 16 |
| 17 | 139,0 | 109,0 | 72,2 | 78,2 | - | - | - | - | - | - | 141,5 | 111,0 | 73,0 | 79,5 | - | - | - | - | 17 |
| 18 | 134,0 | 106,0 | 71,0 | 75,5 | 59,0 | - | - | - | - | - | 135,0 | 108,0 | 71,5 | 77,0 | - | - | - | - | 18 |
| 19 | 129,5 | 103,0 | 69,5 | 73,2 | 57,2 | - | - | - | - | - | 128,0 | 105,5 | 70,2 | 74,7 | 58,0 | - | - | - | 19 |
| 20 | 125,0 | 100,0 | 68,0 | 71,0 | 55,5 | - | 50,0 | - | - | - | 121,0 | 103,0 | 69,0 | 72,5 | 56,5 | - | - | - | 20 |
| 21 | 118,5 | 98,0 | 66,7 | 68,7 | 54,2 | - | 48,5 | - | - | - | 114,5 | 100,7 | 68,0 | 70,2 | 55,0 | - | 48,9 | - | 21 |
| 22 | 112,0 | 96,0 | 65,5 | 66,5 | 53,0 | 35,2 | 47,1 | - | - | - | 108,0 | 98,5 | 67,0 | 68,0 | 53,5 | - | 47,6 | - | 22 |
| 23 | 106,5 | 93,7 | 64,5 | 64,5 | 51,5 | 34,5 | 45,7 | 36,8 | - | - | 103,0 | 96,2 | 65,7 | 66,2 | 52,2 | 34,8 | 46,3 | - | 23 |
| 24 | 101,0 | 91,5 | 63,5 | 62,5 | 50,0 | 33,8 | 44,4 | 35,8 | - | - | 98,0 | 94,0 | 64,5 | 64,5 | 51,0 | 34,1 | 45,0 | 36,0 | 24 |
| 26 | 90,5 | 87,5 | 61,5 | 59,5 | 48,0 | 32,6 | 42,1 | 34,1 | - | - | 89,0 | 90,0 | 62,5 | 61,0 | 49,1 | 33,0 | 42,7 | 34,4 | 26 |
| 28 | 80,5 | 81,5 | 59,5 | 56,5 | 45,9 | 31,5 | 40,0 | 32,6 | - | - | 80,0 | 80,5 | 60,5 | 58,0 | 47,0 | 31,9 | 40,7 | 32,9 | 28 |
| 29 | 76,5 | 77,5 | 58,5 | 55,0 | 44,9 | 30,9 | 39,0 | 31,9 | 21,2 | - | 76,0 | 76,5 | 59,7 | 56,7 | 46,0 | 31,3 | 39,7 | 32,2 | 29 |
| 30 | 72,5 | 73,5 | 57,5 | 53,5 | 44,0 | 30,4 | 38,1 | 31,2 | 20,8 | - | 72,0 | 72,5 | 59,0 | 55,5 | 45,1 | 30,8 | 38,8 | 31,5 | 30 |
| 34 | 60,0 | 60,5 | 54,5 | 49,0 | 40,5 | 28,5 | 34,6 | 28,6 | 19,4 | - | 59,0 | 59,5 | 56,0 | 50,5 | 41,7 | 29,0 | 35,4 | 29,1 | 34 |
| 38 | 50,0 | 50,5 | 51,0 | 45,0 | 37,6 | 26,8 | 31,5 | 26,4 | 18,1 | - | 49,4 | 49,8 | 50,5 | 46,8 | 38,8 | 27,4 | 32,4 | 26,9 | 38 |
| 42 | 42,5 | 42,9 | 43,5 | 41,6 | 35,1 | 25,4 | 29,0 | 24,5 | 17,0 | - | 41,7 | 42,1 | 42,8 | 43,3 | 36,3 | 26,0 | 29,9 | 25,0 | 42 |
| 46 | 36,3 | 36,6 | 37,2 | 38,7 | 32,9 | 24,2 | 26,9 | 22,8 | 16,0 | - | 35,4 | 35,8 | 36,4 | 38,6 | 34,1 | 24,7 | 27,7 | 23,3 | 46 |
| 50 | 31,0 | 31,3 | 31,8 | 34,1 | 31,1 | 23,1 | 25,2 | 21,4 | 15,2 | - | 29,9 | 30,3 | 30,9 | 33,3 | 32,2 | 23,6 | 25,9 | 22,0 | 50 |
| 54 | 26,5 | 26,7 | 27,1 | 29,7 | 29,4 | 22,2 | 23,7 | 20,1 | 14,4 | - | 25,4 | 25,7 | 26,1 | 28,7 | 29,3 | 22,7 | 24,5 | 20,8 | 54 |
| 55 | 25,5 | 25,7 | 26,1 | 28,7 | 28,6 | 22,0 | 23,3 | 19,8 | 14,2 | - | 24,4 | 24,7 | 25,1 | 27,6 | 28,2 | 22,5 | 24,1 | 20,5 | 55 |
| 58 | 22,6 | 22,8 | - | 25,7 | 26,2 | 21,4 | 22,2 | 18,9 | 13,7 | - | 21,5 | 21,8 | 22,2 | 24,7 | 25,2 | 21,9 | 23,1 | 19,6 | 58 |
| 60 | 21,0 | 21,1 | - | 23,9 | 24,4 | 21,0 | 21,5 | 18,4 | 13,4 | - | 19,8 | 20,1 | 20,4 | 22,9 | 23,4 | 21,5 | 22,5 | 19,1 | 60 |
| 62 | 19,4 | 19,5 | - | 22,3 | 22,7 | 20,7 | 20,9 | 17,9 | 13,1 | - | 18,2 | 18,4 | - | 21,2 | 21,7 | 21,2 | 21,8 | 18,6 | 62 |
| 65 | 17,2 | - | - | 20,0 | 20,3 | 20,3 | 20,0 | 17,3 | 12,7 | - | 16,1 | 16,3 | - | 18,9 | 19,3 | 19,7 | 20,7 | 17,9 | 65 |
| 66 | - | - | - | 19,3 | 19,6 | 20,2 | 19,8 | 17,0 | 12,6 | - | 15,4 | 15,6 | - | 18,2 | 18,6 | 19,3 | 20,4 | 17,7 | 66 |
| 67 | - | - | - | 18,6 | 18,9 | 19,5 | 19,5 | 16,8 | 12,4 | - | 14,8 | 14,9 | - | 17,5 | 17,9 | 18,6 | 19,7 | 17,5 | 67 |
| 70 | - | - | - | 16,7 | 16,9 | - | 18,7 | 16,2 | 12,1 | - | 13,0 | - | - | 15,6 | 16,0 | 16,5 | 17,7 | 16,9 | 70 |
| 71 | - | - | - | 16,1 | 16,3 | - | 18,1 | 16,0 | 12,0 | - | 12,4 | - | - | 15,0 | 15,4 | 15,9 | 17,0 | 16,6 | 71 |
| 74 | - | - | - | 14,4 | 14,6 | - | 16,3 | 15,6 | 11,7 | - | - | - | - | 13,3 | 13,6 | - | 15,3 | 15,8 | 74 |
| 77 | - | - | - | 12,8 | - | - | 14,6 | 15,0 | 11,4 | - | - | - | - | 11,7 | 12,0 | - | 13,6 | 14,1 | 77 |
| 78 | - | - | - | - | - | - | 14,1 | 14,5 | 11,4 | - | - | - | - | 11,2 | 11,5 | - | 13,1 | 13,6 | 78 |
| 79 | - | - | - | - | - | - | 13,6 | 14,0 | 11,3 | - | - | - | - | 10,7 | 11,0 | - | 12,6 | 13,1 | 79 |
| 82 | - | - | - | - | - | - | 12,2 | 12,5 | - | - | - | - | - | 9,4 | - | - | 11,2 | 11,6 | 82 |
| 83 | - | - | - | - | - | - | 11,7 | 12,0 | - | - | - | - | - | - | - | - | 10,7 | 11,1 | 83 |
| 86 | - | - | - | - | - | - | 10,5 | 10,7 | - | - | - | - | - | - | - | - | 9,5 | 9,8 | 86 |
| 89 | - | - | - | - | - | - | 9,3 | - | - | - | - | - | - | - | - | - | 8,3 | 8,6 | 89 |
| 90 | - | - | - | - | - | - | - | - | - | - | - | - | - | - | - | - | 7,9 | 8,2 | 90 |
| 91 | - | - | - | - | - | - | - | - | - | - | - | - | - | - | - | - | 7,5 | 7,8 | 91 |
| 94 | - | - | - | - | - | - | - | - | - | - | - | - | - | - | - | - | 6,5 | - | 94 |



| | | 12-36 m | | | | | | 8,40 m | | | 9.8 m/s | | | 360° | | | ISO | | | | |
|----|-------|---------|------|------|------|------|------|---------|------|-----|---------|-------|------|------|------|------|------|------|------|---|----|
| | | 72 m | | | | | | SH+LF_1 | | | | | | | | | 78 m | | | | |
| | | 12 m | | 24 m | | 36 m | | | | | 12 m | | 24 m | | 36 m | | | | | | |
| | | 15° | 20° | 30° | 15° | 20° | 30° | 15° | 20° | 30° | 15° | 20° | 30° | 15° | 20° | 30° | 15° | 20° | 30° | | |
| m | t | t | t | t | t | t | t | t | t | t | t | t | t | t | t | t | t | t | t | t | m |
| 13 | 167,0 | - | - | - | - | - | - | - | - | - | - | - | - | - | - | - | - | - | - | - | 13 |
| 14 | 162,0 | 122,0 | - | - | - | - | - | - | - | - | 163,0 | - | - | - | - | - | - | - | - | - | 14 |
| 15 | 154,5 | 119,0 | - | - | - | - | - | - | - | - | 152,5 | 121,0 | - | - | - | - | - | - | - | - | 15 |
| 16 | 147,0 | 116,0 | 75,0 | - | - | - | - | - | - | - | 142,0 | 118,0 | - | - | - | - | - | - | - | - | 16 |
| 17 | 138,5 | 113,0 | 73,7 | 81,0 | - | - | - | - | - | - | 134,0 | 115,0 | 74,5 | - | - | - | - | - | - | - | 17 |
| 18 | 130,0 | 110,0 | 72,5 | 78,5 | - | - | - | - | - | - | 126,0 | 112,0 | 73,0 | 79,5 | - | - | - | - | - | - | 18 |
| 19 | 123,0 | 107,5 | 71,2 | 76,2 | 58,5 | - | - | - | - | - | 119,0 | 109,5 | 71,7 | 77,5 | - | - | - | - | - | - | 19 |
| 20 | 116,0 | 105,0 | 70,0 | 74,0 | 57,0 | - | - | - | - | - | 112,0 | 107,0 | 70,5 | 75,5 | 58,0 | - | - | - | - | - | 20 |
| 21 | 110,0 | 103,0 | 68,7 | 72,0 | 55,7 | - | 49,3 | - | - | - | 106,5 | 104,5 | 69,5 | 73,5 | 56,7 | - | - | - | - | - | 21 |
| 22 | 104,0 | 101,0 | 67,5 | 70,0 | 54,5 | - | 48,0 | - | - | - | 101,0 | 102,0 | 68,5 | 71,5 | 55,5 | - | 48,1 | - | - | - | 22 |
| 23 | 99,0 | 98,0 | 66,5 | 68,0 | 53,2 | 35,0 | 46,7 | - | - | - | 96,2 | 97,2 | 67,5 | 69,5 | 54,2 | - | 46,9 | - | - | - | 23 |
| 24 | 94,0 | 95,0 | 65,5 | 66,0 | 52,0 | 34,4 | 45,5 | 36,2 | - | - | 91,5 | 92,5 | 66,5 | 67,5 | 53,0 | 34,6 | 45,8 | - | - | - | 24 |
| 25 | 89,7 | 90,7 | 64,5 | 64,5 | 51,0 | 33,8 | 44,4 | 35,4 | - | - | 87,2 | 88,2 | 65,5 | 66,0 | 52,0 | 34,0 | 44,7 | 35,5 | - | - | 25 |
| 26 | 85,5 | 86,5 | 63,5 | 63,0 | 50,0 | 33,3 | 43,3 | 34,6 | - | - | 83,0 | 84,0 | 64,5 | 64,5 | 51,0 | 33,5 | 43,6 | 34,8 | - | - | 26 |
| 28 | 78,0 | 79,0 | 62,0 | 60,0 | 48,0 | 32,2 | 41,3 | 33,2 | - | - | 75,5 | 76,5 | 63,0 | 61,5 | 48,9 | 32,5 | 41,7 | 33,4 | - | - | 28 |
| 30 | 70,5 | 71,0 | 60,0 | 57,0 | 46,1 | 31,2 | 39,5 | 31,9 | 20,9 | - | 69,0 | 70,0 | 61,0 | 58,5 | 47,1 | 31,5 | 40,0 | 32,1 | - | - | 30 |
| 31 | 67,2 | 67,7 | 59,2 | 55,8 | 45,2 | 30,7 | 38,6 | 31,3 | 20,5 | - | 66,0 | 66,8 | 60,2 | 57,3 | 46,2 | 31,0 | 39,2 | 31,5 | 20,5 | - | 31 |
| 34 | 57,5 | 58,0 | 57,0 | 52,5 | 42,8 | 29,4 | 36,2 | 29,5 | 19,6 | - | 57,0 | 57,5 | 58,0 | 54,0 | 43,8 | 29,8 | 36,8 | 29,9 | 19,6 | - | 34 |
| 38 | 47,9 | 48,4 | 49,3 | 48,4 | 39,9 | 27,8 | 33,3 | 27,4 | 18,4 | - | 47,3 | 47,8 | 48,8 | 50,0 | 40,9 | 28,3 | 34,0 | 27,8 | 18,5 | - | 38 |
| 42 | 40,1 | 40,6 | 41,4 | 43,7 | 37,4 | 26,5 | 30,8 | 25,6 | 17,4 | - | 39,5 | 40,0 | 40,8 | 43,1 | 38,4 | 26,9 | 31,5 | 26,0 | 17,5 | - | 42 |
| 46 | 33,6 | 34,0 | 34,8 | 37,3 | 35,2 | 25,2 | 28,5 | 23,9 | 16,5 | - | 32,8 | 33,3 | 34,1 | 36,6 | 36,2 | 25,7 | 29,3 | 24,4 | 16,6 | - | 46 |
| 50 | 28,1 | 28,5 | 29,1 | 31,8 | 32,6 | 24,1 | 26,7 | 22,5 | 15,6 | - | 27,3 | 27,7 | 28,4 | 31,1 | 31,9 | 24,6 | 27,4 | 23,0 | 15,8 | - | 50 |
| 54 | 23,5 | 23,8 | 24,4 | 27,1 | 27,8 | 23,2 | 25,2 | 21,3 | 14,9 | - | 22,7 | 23,1 | 23,7 | 26,3 | 27,1 | 23,6 | 25,8 | 21,7 | 15,1 | - | 54 |
| 58 | 19,6 | 19,9 | 20,4 | 23,0 | 23,7 | 22,3 | 23,9 | 20,2 | 14,3 | - | 18,8 | 19,1 | 19,7 | 22,3 | 22,9 | 22,8 | 24,5 | 20,7 | 14,5 | - | 58 |
| 62 | 16,3 | 16,6 | 16,9 | 19,6 | 20,1 | 21,1 | 22,0 | 19,2 | 13,7 | - | 15,5 | 15,8 | 16,2 | 18,8 | 19,4 | 20,4 | 21,2 | 19,8 | 13,9 | - | 62 |
| 64 | 14,9 | 15,1 | 15,4 | 18,0 | 18,5 | 19,4 | 20,4 | 18,7 | 13,3 | - | 14,0 | 14,3 | 14,7 | 17,2 | 17,8 | 18,8 | 19,6 | 19,3 | 13,6 | - | 64 |
| 66 | 13,5 | 13,7 | - | 16,5 | 17,0 | 17,8 | 18,9 | 18,3 | 13,1 | - | 12,6 | 12,8 | 13,2 | 15,8 | 16,3 | 17,2 | 18,1 | 18,8 | 13,4 | - | 66 |
| 68 | 12,2 | 12,4 | - | 15,2 | 15,6 | 16,4 | 17,5 | 17,5 | 12,9 | - | 11,3 | 11,5 | 11,9 | 14,4 | 14,9 | 15,8 | 16,7 | 17,4 | 13,1 | - | 68 |
| 70 | 11,0 | 11,1 | - | 13,9 | 14,3 | 15,0 | 16,1 | 16,8 | 12,7 | - | 10,1 | 10,3 | - | 13,1 | 13,6 | 14,4 | 15,4 | 16,1 | 12,9 | - | 70 |
| 72 | 9,9 | 10,0 | - | 12,7 | 13,1 | 13,7 | 14,9 | 15,5 | 12,4 | - | 9,0 | 9,2 | - | 11,9 | 12,4 | 13,1 | 14,1 | 14,8 | 12,7 | - | 72 |
| 74 | 8,8 | - | - | 11,6 | 11,9 | 12,5 | 13,7 | 14,3 | 12,2 | - | 7,9 | 8,1 | - | 10,8 | 11,2 | 11,8 | 12,9 | 13,6 | 12,5 | - | 74 |
| 75 | 8,3 | - | - | 11,0 | 11,3 | 11,9 | 13,1 | 13,7 | 12,1 | - | 7,4 | 7,6 | - | 10,2 | 10,6 | 11,2 | 12,3 | 13,0 | 12,4 | - | 75 |
| 76 | 7,8 | - | - | 10,5 | 10,8 | - | 12,6 | 13,2 | 12,0 | - | 6,9 | 7,1 | - | 9,7 | 10,0 | 10,7 | 11,8 | 12,5 | 12,3 | - | 76 |
| 77 | - | - | - | 10,0 | 10,3 | - | 12,1 | 12,6 | 11,9 | - | 6,4 | 6,6 | - | 9,2 | 9,5 | 10,1 | 11,3 | 11,9 | 12,2 | - | 77 |
| 78 | - | - | - | 9,5 | 9,8 | - | 11,6 | 12,1 | 11,9 | - | 6,0 | - | - | 8,7 | 9,0 | 9,6 | 10,8 | 11,4 | 12,1 | - | 78 |
| 80 | - | - | - | 8,5 | 8,8 | - | 10,6 | 11,1 | 11,4 | - | 5,1 | - | - | 7,7 | 8,0 | 8,6 | 9,8 | 10,3 | 11,2 | - | 80 |
| 81 | - | - | - | 8,0 | 8,3 | - | 10,1 | 10,6 | 11,1 | - | 4,7 | - | - | 7,2 | 7,5 | - | 9,3 | 9,8 | 10,7 | - | 81 |
| 82 | - | - | - | 7,6 | 7,9 | - | 9,6 | 10,1 | 10,9 | - | - | - | - | 6,8 | 7,1 | - | 8,8 | 9,4 | 10,3 | - | 82 |
| 84 | - | - | - | 6,8 | 7,0 | - | 8,7 | 9,2 | 9,9 | - | - | - | - | 6,0 | 6,2 | - | 7,9 | 8,5 | 9,3 | - | 84 |
| 86 | - | - | - | 6,0 | - | - | 7,9 | 8,3 | 9,0 | - | - | - | - | 5,2 | 5,4 | - | 7,1 | 7,6 | 8,4 | - | 86 |
| 87 | - | - | - | 5,6 | - | - | 7,5 | 7,9 | 8,5 | - | - | - | - | 4,8 | 5,0 | - | 6,7 | 7,1 | 7,9 | - | 87 |
| 89 | - | - | - | - | - | - | 6,7 | 7,1 | - | - | - | - | - | 4,0 | 4,2 | - | 5,9 | 6,3 | 7,0 | - | 89 |
| 90 | - | - | - | - | - | - | 6,3 | 6,7 | - | - | - | - | - | 3,7 | - | - | 5,5 | 5,9 | 6,6 | - | 90 |
| 91 | - | - | - | - | - | - | 5,9 | 6,3 | - | - | - | - | - | - | - | - | 5,1 | 5,5 | 6,2 | - | 91 |
| 94 | - | - | - | - | - | - | 4,9 | 5,2 | - | - | - | - | - | - | - | - | 4,1 | 4,4 | - | - | 94 |
| 95 | - | - | - | - | - | - | 4,5 | 4,8 | - | - | - | - | - | - | - | - | 3,7 | 4,0 | - | - | 95 |
| 96 | - | - | - | - | - | - | 4,2 | - | - | - | - | - | - | - | - | - | - | 3,7 | - | - | 96 |
| 98 | - | - | - | - | - | - | 3,5 | - | - | - | - | - | - | - | - | - | - | - | - | - | 98 |

45t
85t
125t
165t
185t
205t

0t
30t
50t

| | | 12-36 m | | | | | | | | | 8,40 m | | | 9.8 m/s | | | 360° | | | ISO |
|----|-------|---------|------|------|------|------|------|------|------|-----|--------|-----|-----|---------|-----|-----|------|-----|-----|-----|
| | | 84 m | | | | | | | | | 90 m | | | | | | 96 m | | | |
| | | SH+LF_1 | | | | | | | | | | | | | | | | | | |
| | | 12 m | | | 24 m | | | 36 m | | | 12 m | | | 24 m | | | 12 m | | | |
| | | 15° | 20° | 30° | 15° | 20° | 30° | 15° | 20° | 30° | 15° | 20° | 30° | 15° | 20° | 30° | 15° | 20° | 30° | |
| m | t | t | t | t | t | t | t | t | t | t | t | t | t | t | t | t | t | t | t | m |
| 14 | 156,0 | - | - | - | - | - | - | - | - | - | - | - | - | - | - | - | - | - | - | 14 |
| 15 | 146,5 | 122,0 | - | - | - | - | - | - | - | - | - | - | - | - | - | - | - | - | - | 15 |
| 16 | 137,0 | 119,0 | - | - | - | - | - | - | - | - | - | - | - | - | - | - | - | - | - | 16 |
| 17 | 129,0 | 116,5 | 75,0 | - | - | - | - | - | - | - | - | - | - | - | - | - | - | - | - | 17 |
| 18 | 121,0 | 114,0 | 73,5 | 80,5 | - | - | - | - | - | - | - | - | - | - | - | - | - | - | - | 18 |
| 19 | 114,5 | 111,5 | 72,5 | 78,5 | - | - | - | - | - | - | - | - | - | - | - | - | - | - | - | 19 |
| 20 | 108,0 | 109,0 | 71,5 | 76,5 | 58,5 | - | - | - | - | - | - | - | - | - | - | - | - | - | - | 20 |
| 21 | 102,5 | 103,5 | 70,2 | 74,5 | 57,2 | - | - | - | - | - | - | - | - | - | - | - | - | - | - | 21 |
| 22 | 97,0 | 98,0 | 69,0 | 72,5 | 56,0 | - | 48,4 | - | - | - | - | - | - | - | - | - | - | - | - | 22 |
| 24 | 87,5 | 88,5 | 67,0 | 69,0 | 53,5 | 34,8 | 46,1 | - | - | - | - | - | - | - | - | - | - | - | - | 24 |
| 25 | 83,5 | 84,5 | 66,2 | 67,5 | 52,5 | 34,2 | 45,0 | - | - | - | - | - | - | - | - | - | - | - | - | 25 |
| 26 | 79,5 | 80,5 | 65,5 | 66,0 | 51,5 | 33,7 | 44,0 | 34,9 | - | - | - | - | - | - | - | - | - | - | - | 26 |
| 28 | 72,0 | 73,0 | 63,5 | 63,0 | 49,8 | 32,8 | 42,2 | 33,6 | - | - | - | - | - | - | - | - | - | - | - | 28 |
| 30 | 66,0 | 67,0 | 62,0 | 60,0 | 48,0 | 31,8 | 40,5 | 32,4 | - | - | - | - | - | - | - | - | - | - | - | 30 |
| 31 | 63,3 | 64,2 | 60,8 | 58,8 | 47,1 | 31,3 | 39,7 | 31,8 | 20,5 | - | - | - | - | - | - | - | - | - | - | 31 |
| 34 | 55,5 | 56,0 | 57,5 | 55,5 | 44,7 | 30,1 | 37,4 | 30,2 | 19,7 | - | - | - | - | - | - | - | - | - | - | 34 |
| 38 | 45,8 | 46,4 | 47,5 | 49,0 | 41,8 | 28,6 | 34,7 | 28,3 | 18,6 | - | - | - | - | - | - | - | - | - | - | 38 |
| 42 | 37,7 | 38,3 | 39,4 | 41,8 | 39,4 | 27,3 | 32,2 | 26,5 | 17,7 | - | - | - | - | - | - | - | - | - | - | 42 |
| 46 | 31,0 | 31,5 | 32,5 | 35,2 | 36,2 | 26,1 | 30,0 | 24,9 | 16,8 | - | - | - | - | - | - | - | - | - | - | 46 |
| 50 | 25,5 | 25,9 | 26,8 | 29,5 | 30,4 | 25,0 | 28,1 | 23,5 | 16,0 | - | - | - | - | - | - | - | - | - | - | 50 |
| 54 | 20,9 | 21,3 | 22,0 | 24,7 | 25,5 | 24,1 | 26,5 | 22,2 | 15,3 | - | - | - | - | - | - | - | - | - | - | 54 |
| 58 | 17,0 | 17,3 | 17,9 | 20,6 | 21,4 | 22,7 | 23,4 | 21,1 | 14,7 | - | - | - | - | - | - | - | - | - | - | 58 |
| 62 | 13,6 | 13,9 | 14,4 | 17,1 | 17,8 | 19,0 | 19,8 | 20,3 | 14,1 | - | - | - | - | - | - | - | - | - | - | 62 |
| 66 | 10,7 | 11,0 | 11,4 | 14,1 | 14,7 | 15,7 | 16,6 | 17,5 | 13,6 | - | - | - | - | - | - | - | - | - | - | 66 |
| 70 | 8,2 | 8,4 | 8,8 | 11,4 | 11,9 | 12,8 | 13,8 | 14,7 | 13,1 | - | - | - | - | - | - | - | - | - | - | 70 |
| 71 | 7,6 | 7,8 | 8,2 | 10,8 | 11,3 | 12,1 | 13,2 | 14,0 | 13,0 | - | - | - | - | - | - | - | - | - | - | 71 |
| 72 | 7,0 | 7,3 | 7,6 | 10,2 | 10,7 | 11,5 | 12,6 | 13,4 | 12,9 | - | - | - | - | - | - | - | - | - | - | 72 |
| 73 | 6,5 | 6,7 | - | 9,6 | 10,1 | 10,9 | 12,0 | 12,7 | 12,8 | - | - | - | - | - | - | - | - | - | - | 73 |
| 74 | 6,0 | 6,2 | - | 9,1 | 9,5 | 10,3 | 11,4 | 12,1 | 12,7 | - | - | - | - | - | - | - | - | - | - | 74 |
| 75 | 5,5 | 5,7 | - | 8,5 | 8,9 | 9,7 | 10,8 | 11,5 | 12,3 | - | - | - | - | - | - | - | - | - | - | 75 |
| 76 | 5,0 | 5,2 | - | 8,0 | 8,4 | 9,2 | 10,2 | 10,9 | 11,9 | - | - | - | - | - | - | - | - | - | - | 76 |
| 78 | 4,0 | 4,2 | - | 7,0 | 7,4 | 8,1 | 9,2 | 9,9 | 11,1 | - | - | - | - | - | - | - | - | - | - | 78 |
| 79 | 3,6 | 3,7 | - | 6,5 | 6,9 | 7,5 | 8,7 | 9,4 | 10,5 | - | - | - | - | - | - | - | - | - | - | 79 |
| 82 | - | - | - | 5,1 | 5,4 | 6,0 | 7,3 | 7,9 | 8,9 | - | - | - | - | - | - | - | - | - | - | 82 |
| 83 | - | - | - | 4,6 | 4,9 | 5,5 | 6,8 | 7,4 | 8,4 | - | - | - | - | - | - | - | - | - | - | 83 |
| 84 | - | - | - | 4,2 | 4,5 | 5,1 | 6,3 | 6,9 | 7,9 | - | - | - | - | - | - | - | - | - | - | 84 |
| 85 | - | - | - | 3,8 | 4,1 | - | 5,9 | 6,5 | 7,4 | - | - | - | - | - | - | - | - | - | - | 85 |
| 86 | - | - | - | - | 3,7 | - | 5,5 | 6,0 | 7,0 | - | - | - | - | - | - | - | - | - | - | 86 |
| 90 | - | - | - | - | - | - | 3,9 | 4,4 | 5,2 | - | - | - | - | - | - | - | - | - | - | 90 |
| 91 | - | - | - | - | - | - | 3,5 | 4,0 | 4,8 | - | - | - | - | - | - | - | - | - | - | 91 |
| 92 | - | - | - | - | - | - | - | 3,6 | 4,4 | - | - | - | - | - | - | - | - | - | - | 92 |
| 94 | - | - | - | - | - | - | - | - | 3,6 | - | - | - | - | - | - | - | - | - | - | 94 |



| | | 12 m | | | 8,40 m | | | 9.8 m/s | | | 360° | | | ISO | | | | | | | |
|----|-------|---------|------|-------|--------|------|-------|---------|------|-------|-------|------|-------|---------|------|-------|-------|-------|-------|------|---|
| | | 48 m | | 54 m | | 60 m | | 66 m | | 72 m | | 75 m | | | | | | | | | |
| | | LH+LF_1 | | | | | | | | | | | | LH+LF_3 | | | | | | | |
| | | 12 m | | | | | | | | | | | | | | | | | | | |
| | | 15° | 20° | 30° | 15° | 20° | 30° | 15° | 20° | 30° | 15° | 20° | 30° | 15° | 20° | 30° | 15° | 20° | 15° | 20° | |
| m | t | t | t | t | t | t | t | t | t | t | t | t | t | t | t | t | t | t | t | t | |
| 10 | 178,0 | - | - | - | - | - | - | - | - | - | - | - | - | - | - | - | - | - | - | - | |
| 11 | 170,0 | 132,0 | - | 175,0 | - | - | 178,0 | - | - | - | - | - | - | - | - | - | - | - | - | - | |
| 12 | 162,0 | 127,0 | - | 167,0 | 130,0 | - | 172,0 | 132,0 | - | 168,0 | - | - | 160,0 | - | - | 155,0 | - | 154,0 | - | - | |
| 13 | 155,5 | 122,5 | 82,0 | 160,5 | 125,5 | 83,0 | 165,5 | 128,0 | - | 163,0 | 130,0 | - | 155,5 | 132,0 | - | 152,0 | 114,0 | 151,5 | - | - | |
| 14 | 149,0 | 118,0 | 80,0 | 154,0 | 121,0 | 81,0 | 159,0 | 124,0 | 82,0 | 158,0 | 126,0 | 82,5 | 151,0 | 128,0 | - | 149,0 | 111,0 | 149,0 | 112,0 | - | |
| 15 | 143,5 | 114,5 | 78,0 | 148,5 | 117,5 | 79,2 | 153,5 | 120,5 | 80,2 | 153,0 | 123,0 | 81,0 | 147,0 | 125,0 | 81,5 | 145,0 | 108,5 | 146,0 | 109,0 | - | |
| 16 | 138,0 | 111,0 | 76,0 | 143,0 | 114,0 | 77,5 | 148,0 | 117,0 | 78,5 | 148,0 | 120,0 | 79,5 | 143,0 | 122,0 | 80,0 | 141,0 | 106,0 | 143,0 | 106,0 | - | |
| 18 | 128,0 | 104,0 | 72,5 | 134,0 | 108,0 | 74,0 | 139,0 | 111,0 | 75,5 | 140,0 | 114,0 | 76,5 | 135,0 | 116,0 | 77,5 | 133,0 | 101,0 | 132,0 | 102,0 | - | |
| 20 | 120,0 | 99,0 | 69,5 | 126,0 | 102,0 | 71,0 | 130,0 | 105,0 | 72,5 | 125,0 | 108,0 | 73,5 | 121,0 | 111,0 | 74,5 | 121,0 | 96,5 | 119,0 | 97,5 | - | |
| 22 | 113,0 | 94,0 | 67,0 | 118,0 | 97,5 | 68,5 | 117,0 | 100,0 | 70,0 | 113,0 | 103,0 | 71,0 | 109,0 | 106,0 | 72,5 | 109,0 | 92,0 | 107,0 | 93,0 | - | |
| 24 | 106,0 | 89,0 | 64,5 | 110,0 | 93,0 | 66,0 | 106,0 | 96,0 | 67,5 | 102,0 | 99,0 | 69,0 | 99,5 | 100,0 | 70,0 | 99,0 | 88,5 | 97,0 | 89,5 | - | |
| 26 | 97,0 | 85,0 | 62,0 | 96,0 | 88,5 | 64,0 | 95,0 | 92,0 | 65,5 | 93,5 | 94,5 | 66,5 | 90,5 | 91,5 | 68,0 | 90,5 | 85,0 | 88,5 | 86,0 | - | |
| 28 | 87,5 | 81,5 | 60,0 | 86,5 | 85,0 | 61,5 | 85,5 | 86,0 | 63,5 | 84,0 | 84,5 | 64,5 | 83,0 | 84,0 | 66,0 | 83,0 | 82,0 | 81,5 | 82,0 | - | |
| 30 | 79,5 | 78,0 | 58,0 | 78,5 | 79,0 | 60,0 | 77,0 | 77,5 | 61,5 | 76,0 | 76,5 | 63,0 | 75,0 | 75,5 | 64,0 | 75,0 | 75,5 | 74,5 | 75,0 | - | |
| 34 | 66,5 | 67,0 | 54,5 | 65,5 | 66,0 | 56,5 | 64,0 | 64,5 | 58,0 | 63,0 | 63,5 | 59,5 | 62,0 | 62,5 | 61,0 | 62,0 | 62,5 | 61,0 | 62,0 | - | |
| 38 | 57,0 | 57,0 | 52,0 | 55,5 | 56,0 | 53,5 | 54,5 | 54,5 | 55,5 | 53,0 | 53,5 | 54,0 | 52,0 | 52,5 | 53,0 | 52,0 | 52,5 | 51,5 | 51,5 | - | |
| 42 | 49,4 | 49,6 | 49,9 | 48,1 | 48,4 | 48,8 | 46,8 | 47,1 | 47,6 | 45,4 | 45,8 | 46,3 | 44,5 | 44,8 | 45,5 | 44,3 | 44,7 | 43,6 | 44,0 | - | |
| 46 | 43,2 | 43,3 | 43,6 | 41,9 | 42,1 | 42,4 | 40,5 | 40,8 | 41,2 | 39,1 | 39,4 | 39,9 | 38,2 | 38,5 | 39,0 | 38,0 | 38,4 | 37,3 | 37,6 | - | |
| 47 | 41,9 | 42,0 | 42,2 | 40,6 | 40,8 | 41,1 | 39,2 | 39,4 | 39,8 | 37,8 | 38,1 | 38,5 | 36,9 | 37,1 | 37,6 | 36,7 | 37,0 | 35,9 | 36,2 | - | |
| 50 | 38,1 | 38,2 | - | 36,8 | 36,9 | 37,2 | 35,4 | 35,6 | 36,0 | 34,0 | 34,2 | 34,6 | 33,0 | 33,2 | 33,7 | 32,8 | 33,1 | 31,9 | 32,3 | - | |
| 51 | 37,0 | 37,1 | - | 35,7 | 35,8 | 36,0 | 34,3 | 34,5 | 34,9 | 32,9 | 33,1 | 33,5 | 31,8 | 32,0 | 32,5 | 31,6 | 31,9 | 30,7 | 31,1 | - | |
| 53 | 34,9 | 35,0 | - | 33,5 | 33,7 | - | 32,1 | 32,3 | 32,7 | 30,7 | 30,9 | 31,3 | 29,5 | 29,7 | 30,2 | 29,3 | 29,6 | 28,4 | 28,7 | - | |
| 54 | 33,9 | - | - | 32,5 | 32,7 | - | 31,1 | 31,3 | 31,6 | 29,6 | 29,8 | 30,2 | 28,4 | 28,6 | 29,1 | 28,2 | 28,5 | 27,3 | 27,6 | - | |
| 55 | 33,0 | - | - | 31,6 | 31,7 | - | 30,1 | 30,3 | 30,6 | 28,6 | 28,8 | 29,2 | 27,3 | 27,6 | 28,0 | 27,2 | 27,4 | 26,3 | 26,6 | - | |
| 56 | - | - | - | 30,7 | 30,8 | - | 29,2 | 29,4 | 29,6 | 27,6 | 27,8 | 28,2 | 26,3 | 26,6 | 27,0 | 26,2 | 26,4 | 25,3 | 25,6 | - | |
| 57 | - | - | - | 29,8 | 29,9 | - | 28,3 | 28,5 | - | 26,6 | 26,8 | 27,2 | 25,4 | 25,6 | 26,0 | 25,2 | 25,4 | 24,3 | 24,6 | - | |
| 58 | - | - | - | 28,9 | - | - | 27,4 | 27,6 | - | 25,7 | 25,9 | - | 24,0 | 24,1 | 24,4 | 22,8 | 23,0 | 22,8 | 21,7 | 21,9 | - |
| 60 | - | - | - | 27,4 | - | - | 25,7 | 25,9 | - | 24,0 | 24,1 | - | 22,4 | 22,5 | - | 21,1 | 21,3 | 21,6 | 20,9 | 20,2 | - |
| 62 | - | - | - | - | - | - | 24,1 | 24,3 | - | 22,4 | 22,5 | - | 21,1 | 21,3 | 21,6 | 20,9 | 21,1 | 20,0 | 20,2 | - | - |
| 64 | - | - | - | - | - | - | 22,7 | - | - | 20,9 | 21,0 | - | 19,6 | 19,8 | 20,1 | 19,5 | 19,6 | 18,5 | 18,7 | - | - |
| 65 | - | - | - | - | - | - | 22,0 | - | - | 20,2 | 20,3 | - | 18,9 | 19,1 | - | 18,8 | 18,9 | 17,8 | 18,0 | - | - |
| 66 | - | - | - | - | - | - | - | - | - | 19,5 | 19,6 | - | 18,2 | 18,4 | - | 18,1 | 18,2 | 17,1 | 17,3 | - | - |
| 67 | - | - | - | - | - | - | - | - | - | 18,8 | 19,0 | - | 17,5 | 17,7 | - | 17,4 | 17,5 | 16,4 | 16,6 | - | - |
| 70 | - | - | - | - | - | - | - | - | - | 17,0 | - | - | 15,7 | 15,9 | - | 15,6 | 15,7 | 14,6 | 14,7 | - | - |
| 71 | - | - | - | - | - | - | - | - | - | 16,5 | - | - | 15,1 | 15,3 | - | 15,0 | 15,1 | 14,0 | 14,1 | - | - |
| 72 | - | - | - | - | - | - | - | - | - | - | - | - | 14,6 | 14,7 | - | 14,5 | 14,6 | 13,5 | 13,6 | - | - |
| 74 | - | - | - | - | - | - | - | - | - | - | - | - | 13,6 | - | - | 13,4 | - | 12,4 | 12,5 | - | - |
| 76 | - | - | - | - | - | - | - | - | - | - | - | - | 12,6 | - | - | 12,4 | - | 11,4 | - | - | - |
| 78 | - | - | - | - | - | - | - | - | - | - | - | - | - | - | - | - | - | 10,5 | - | - | - |

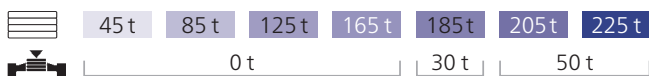

|  12 m 8,40 m 9.8 m/s 360° ISO | | | | | | | | | | | | | | | | | | | |
|---|-------|-------|---------|-------|---------|-------|---------|-------|---------|------|---------|-------|---------|-------|-------|-------|-------|-------|----|
| 78 m | | | | | 81 m | | | | 84 m | | | | 87 m | | | | | | |
| LH+LF_1 | | | LH+LF_3 | | LH+LF_1 | | LH+LF_3 | | LH+LF_4 | | LH+LF_3 | | LH+LF_4 | | | | | | |
| 12 m | | | | | | | | | | | | | | | | | | | |
| 15° | | 20° | | 30° | | 15° | | 20° | | 15° | | 20° | | 15° | | 20° | | 15° | |
| m | t | t | t | t | t | t | t | t | t | t | t | t | t | t | t | t | t | t | m |
| 13 | 145,0 | - | - | 158,0 | - | 159,0 | - | 137,0 | - | - | 154,0 | - | 175,0 | - | - | - | - | - | 13 |
| 14 | 141,0 | 125,0 | - | 153,0 | 113,0 | 155,0 | 113,0 | 135,0 | 124,0 | - | 151,0 | 114,0 | 168,0 | - | 146,0 | - | 164,0 | - | 14 |
| 15 | 137,0 | 122,0 | - | 148,5 | 110,0 | 150,0 | 110,5 | 133,5 | 123,0 | - | 146,5 | 111,5 | 161,0 | 137,0 | 142,5 | 112,0 | 158,0 | 137,0 | 15 |
| 16 | 133,0 | 119,0 | 81,0 | 144,0 | 107,0 | 145,0 | 108,0 | 132,0 | 122,0 | 81,5 | 142,0 | 109,0 | 155,0 | 134,0 | 139,0 | 109,0 | 152,0 | 134,0 | 16 |
| 18 | 126,0 | 113,0 | 78,0 | 131,0 | 102,0 | 129,0 | 103,0 | 125,0 | 119,0 | 79,0 | 127,0 | 104,0 | 140,0 | 128,0 | 124,0 | 105,0 | 138,0 | 129,0 | 18 |
| 20 | 116,0 | 108,0 | 75,5 | 118,0 | 98,5 | 115,0 | 99,0 | 113,0 | 114,0 | 76,5 | 113,0 | 100,0 | 125,0 | 123,0 | 111,0 | 101,0 | 123,0 | 124,0 | 20 |
| 22 | 105,0 | 103,0 | 73,0 | 106,0 | 94,0 | 104,0 | 95,0 | 102,0 | 103,0 | 74,0 | 102,0 | 96,0 | 112,0 | 114,0 | 100,0 | 97,0 | 110,0 | 111,0 | 22 |
| 24 | 95,5 | 96,5 | 71,0 | 97,0 | 90,5 | 94,5 | 91,5 | 93,0 | 94,0 | 72,0 | 93,5 | 92,5 | 102,0 | 103,0 | 91,0 | 92,0 | 100,0 | 101,0 | 24 |
| 26 | 87,0 | 88,0 | 69,0 | 88,5 | 87,0 | 86,5 | 87,5 | 85,0 | 85,5 | 70,0 | 85,0 | 86,0 | 92,5 | 93,5 | 83,0 | 84,0 | 90,5 | 91,5 | 26 |
| 28 | 80,0 | 80,5 | 67,0 | 81,5 | 82,0 | 79,5 | 80,0 | 77,5 | 78,5 | 68,0 | 78,0 | 79,0 | 84,5 | 85,5 | 76,0 | 77,0 | 82,5 | 83,5 | 28 |
| 30 | 73,5 | 74,0 | 65,5 | 75,0 | 75,5 | 73,0 | 73,5 | 71,5 | 72,0 | 66,5 | 72,0 | 72,5 | 77,0 | 78,0 | 70,0 | 70,5 | 75,5 | 76,5 | 30 |
| 34 | 60,5 | 61,0 | 62,0 | 62,0 | 62,5 | 61,0 | 61,5 | 60,5 | 61,0 | 62,0 | 60,5 | 61,0 | 63,0 | 64,0 | 59,5 | 60,0 | 62,5 | 63,0 | 34 |
| 38 | 50,5 | 51,0 | 52,0 | 52,0 | 52,5 | 51,0 | 51,5 | 50,5 | 51,0 | 51,5 | 50,5 | 51,0 | 52,5 | 53,0 | 49,7 | 50,0 | 51,5 | 52,0 | 38 |
| 42 | 43,1 | 43,5 | 44,2 | 44,3 | 44,6 | 43,3 | 43,7 | 42,6 | 43,0 | 43,8 | 42,9 | 43,3 | 44,2 | 44,7 | 41,9 | 42,3 | 43,3 | 43,8 | 42 |
| 46 | 36,7 | 37,1 | 37,7 | 38,0 | 38,3 | 36,9 | 37,3 | 36,3 | 36,6 | 37,3 | 36,6 | 36,9 | 37,2 | 37,7 | 35,3 | 35,8 | 36,2 | 36,7 | 46 |
| 50 | 31,3 | 31,6 | 32,2 | 32,7 | 33,0 | 31,5 | 31,8 | 30,7 | 31,1 | 31,8 | 31,0 | 31,4 | 31,3 | 31,7 | 29,8 | 30,2 | 30,2 | 30,6 | 50 |
| 54 | 26,6 | 26,9 | 27,5 | 28,1 | 28,4 | 26,8 | 27,1 | 26,1 | 26,4 | 27,0 | 26,4 | 26,7 | 26,3 | 26,7 | 25,1 | 25,5 | 25,2 | 25,6 | 54 |
| 58 | 22,7 | 23,0 | 23,4 | 24,2 | 24,4 | 22,9 | 23,2 | 22,1 | 22,4 | 22,9 | 22,5 | 22,7 | 22,1 | 22,4 | 21,1 | 21,5 | 21,0 | 21,3 | 58 |
| 62 | 19,3 | 19,6 | 20,0 | 20,8 | 21,0 | 19,5 | 19,8 | 18,8 | 19,0 | 19,4 | 19,1 | 19,3 | 18,5 | 18,7 | 17,8 | 18,0 | 17,3 | 17,7 | 62 |
| 66 | 16,4 | 16,6 | 17,0 | 17,9 | 18,1 | 16,6 | 16,8 | 15,8 | 16,1 | 16,4 | 16,2 | 16,4 | 15,3 | 15,6 | 14,8 | 15,1 | 14,2 | 14,5 | 66 |
| 68 | 15,1 | 15,3 | 15,6 | 16,6 | 16,8 | 15,3 | 15,5 | 14,5 | 14,8 | 15,1 | 14,9 | 15,1 | 13,9 | 14,2 | 13,5 | 13,8 | 12,8 | 13,1 | 68 |
| 70 | 13,9 | 14,1 | - | 15,4 | 15,6 | 14,1 | 14,3 | 13,3 | 13,5 | 13,8 | 13,6 | 13,8 | 12,6 | 12,8 | 12,3 | 12,5 | 11,5 | 11,7 | 70 |
| 73 | 12,2 | 12,3 | - | 13,7 | 13,8 | 12,4 | 12,5 | 11,6 | 11,7 | 12,1 | 11,9 | 12,1 | 10,8 | 11,0 | 10,5 | 10,7 | 9,6 | 9,9 | 73 |
| 74 | 11,7 | 11,8 | - | 13,2 | 13,3 | 11,9 | 12,0 | 11,1 | 11,2 | - | 11,4 | 11,6 | 10,2 | 10,4 | 10,0 | 10,2 | 9,1 | 9,3 | 74 |
| 77 | 10,2 | 10,4 | - | 11,7 | 11,8 | 10,4 | 10,5 | 9,6 | 9,7 | - | 9,9 | 10,0 | 8,6 | 8,8 | 8,5 | 8,7 | 7,5 | 7,6 | 77 |
| 78 | 9,8 | - | - | 11,3 | - | 9,9 | 10,0 | 9,1 | 9,3 | - | 9,4 | 9,6 | 8,1 | 8,3 | 8,1 | 8,2 | 7,0 | 7,1 | 78 |
| 79 | 9,3 | - | - | 10,8 | - | 9,4 | 9,6 | 8,6 | 8,8 | - | 8,9 | 9,1 | 7,6 | 7,8 | 7,6 | 7,7 | 6,5 | 6,6 | 79 |
| 81 | 8,5 | - | - | 10,0 | - | 8,6 | - | 7,8 | 7,9 | - | 8,1 | 8,2 | 6,7 | 6,8 | 6,7 | 6,9 | 5,5 | 5,7 | 81 |
| 82 | - | - | - | - | - | 8,2 | - | 7,4 | 7,5 | - | 7,7 | - | 6,3 | 6,4 | 6,3 | 6,4 | 5,1 | 5,2 | 82 |
| 83 | - | - | - | - | - | 7,8 | - | 7,0 | - | - | 7,3 | - | 5,8 | - | 5,9 | 6,0 | 4,6 | 4,8 | 83 |
| 84 | - | - | - | - | - | - | - | 6,6 | - | - | 6,9 | - | 5,4 | - | 5,5 | 5,6 | 4,2 | 4,4 | 84 |
| 85 | - | - | - | - | - | - | - | 6,2 | - | - | 6,6 | - | 5,0 | - | 5,1 | - | 3,8 | - | 85 |
| 86 | - | - | - | - | - | - | - | 5,9 | - | - | 6,2 | - | 4,6 | - | 4,8 | - | - | - | 86 |
| 89 | - | - | - | - | - | - | - | - | - | - | - | - | - | - | 3,8 | - | - | - | 89 |



| 12 m 8,40 m 9.8 m/s 360° ISO | | | | | | | | | | | | | | | | | | | | | | | | | | | | | | | | |
|--|-------|-------|---------|-------|-------|---------|-------|-------|---------|-------|-------|---------|-------|------|---------|-------|-------|---------|----|--|---------|--|--|-----|--|--|-----|--|--|-----|--|--|
| 90 m | | | | | | 93 m | | | | | | 96 m | | | | | | | | | | | | | | | | | | | | |
| LH+LF_1 | | | LH+LF_3 | | | LH+LF_4 | | | LH+LF_3 | | | LH+LF_4 | | | LH+LF_1 | | | LH+LF_3 | | | LH+LF_4 | | | | | | | | | | | |
| 12 m | | | | | | | | | | | | | | | | | | | | | | | | | | | | | | | | |
| 15° | | | 20° | | | 30° | | | 15° | | | 20° | | | 15° | | | 20° | | | 15° | | | 20° | | | 15° | | | 20° | | |
| m | t | t | t | t | t | t | t | t | t | t | t | t | t | t | t | t | t | t | m | | | | | | | | | | | | | |
| 14 | 126,0 | - | - | 136,0 | - | 160,0 | - | 131,0 | - | 156,0 | - | 112,0 | - | - | 125,0 | - | 154,0 | - | 14 | | | | | | | | | | | | | |
| 15 | 124,5 | 113,0 | - | 134,0 | 113,0 | 154,0 | 138,0 | 129,0 | 113,0 | 150,0 | 138,0 | 110,5 | 102,0 | - | 123,0 | 114,0 | 149,0 | - | 15 | | | | | | | | | | | | | |
| 16 | 123,0 | 112,0 | - | 132,0 | 110,0 | 148,0 | 135,0 | 127,0 | 111,0 | 145,0 | 136,0 | 109,0 | 101,0 | - | 121,0 | 111,0 | 143,0 | 136,0 | 16 | | | | | | | | | | | | | |
| 17 | 120,5 | 110,5 | 80,5 | 127,0 | 108,0 | 143,0 | 132,0 | 123,5 | 108,5 | 140,0 | 133,0 | 108,0 | 99,7 | 81,0 | 119,0 | 109,0 | 138,0 | 133,0 | 17 | | | | | | | | | | | | | |
| 18 | 118,0 | 109,0 | 79,5 | 122,0 | 106,0 | 135,0 | 129,0 | 120,0 | 106,0 | 133,0 | 130,0 | 107,0 | 98,5 | 80,0 | 117,0 | 107,0 | 130,0 | 130,0 | 18 | | | | | | | | | | | | | |
| 20 | 109,0 | 106,0 | 77,0 | 110,0 | 101,0 | 121,0 | 122,0 | 107,0 | 102,0 | 118,0 | 120,0 | 104,0 | 96,0 | 77,5 | 106,0 | 103,0 | 116,0 | 118,0 | 20 | | | | | | | | | | | | | |
| 22 | 98,5 | 99,5 | 75,0 | 99,5 | 97,5 | 108,0 | 110,0 | 97,0 | 98,0 | 106,0 | 107,0 | 95,0 | 93,5 | 75,5 | 95,5 | 96,5 | 104,0 | 105,0 | 22 | | | | | | | | | | | | | |
| 24 | 89,5 | 90,0 | 73,0 | 90,5 | 91,5 | 98,0 | 99,5 | 88,0 | 89,0 | 96,0 | 97,0 | 86,5 | 87,5 | 73,5 | 87,0 | 88,0 | 94,0 | 95,5 | 24 | | | | | | | | | | | | | |
| 26 | 81,5 | 82,5 | 71,0 | 82,5 | 83,5 | 89,0 | 90,0 | 80,5 | 81,0 | 87,0 | 88,0 | 78,5 | 79,5 | 71,5 | 79,0 | 80,0 | 85,5 | 86,5 | 26 | | | | | | | | | | | | | |
| 28 | 74,5 | 75,5 | 69,0 | 75,5 | 76,5 | 81,0 | 82,0 | 73,5 | 74,5 | 79,5 | 80,5 | 72,0 | 73,0 | 70,0 | 72,5 | 73,5 | 77,5 | 79,0 | 28 | | | | | | | | | | | | | |
| 30 | 68,5 | 69,0 | 67,5 | 69,5 | 70,0 | 74,5 | 75,0 | 67,5 | 68,5 | 72,5 | 73,5 | 66,0 | 67,0 | 68,0 | 66,5 | 67,5 | 71,0 | 72,0 | 30 | | | | | | | | | | | | | |
| 34 | 58,0 | 59,0 | 60,0 | 59,5 | 60,0 | 61,5 | 62,5 | 57,5 | 58,0 | 61,0 | 61,5 | 56,0 | 56,5 | 58,0 | 56,5 | 57,0 | 59,5 | 60,5 | 34 | | | | | | | | | | | | | |
| 38 | 49,1 | 49,7 | 50,5 | 49,9 | 50,0 | 51,0 | 51,5 | 48,9 | 49,5 | 50,0 | 51,0 | 48,1 | 48,7 | 49,8 | 48,6 | 49,1 | 49,6 | 50,0 | 38 | | | | | | | | | | | | | |
| 42 | 41,2 | 41,7 | 42,5 | 42,1 | 42,5 | 42,7 | 43,3 | 41,0 | 41,5 | 41,7 | 42,3 | 40,4 | 40,8 | 41,7 | 40,7 | 41,2 | 40,8 | 41,5 | 42 | | | | | | | | | | | | | |
| 46 | 34,6 | 35,1 | 35,9 | 35,6 | 36,0 | 35,5 | 36,0 | 34,4 | 34,8 | 34,4 | 35,0 | 33,6 | 34,1 | 35,0 | 34,0 | 34,4 | 33,5 | 34,1 | 46 | | | | | | | | | | | | | |
| 50 | 29,0 | 29,5 | 30,2 | 30,0 | 30,4 | 29,5 | 29,9 | 28,8 | 29,2 | 28,4 | 28,9 | 28,0 | 28,4 | 29,2 | 28,4 | 28,8 | 27,5 | 28,0 | 50 | | | | | | | | | | | | | |
| 54 | 24,4 | 24,7 | 25,4 | 25,4 | 25,7 | 24,5 | 24,9 | 24,1 | 24,5 | 23,4 | 23,8 | 23,3 | 23,7 | 24,4 | 23,7 | 24,1 | 22,5 | 22,9 | 54 | | | | | | | | | | | | | |
| 58 | 20,4 | 20,7 | 21,3 | 21,4 | 21,7 | 20,2 | 20,6 | 20,1 | 20,4 | 19,1 | 19,5 | 19,3 | 19,7 | 20,3 | 19,7 | 20,0 | 18,2 | 18,6 | 58 | | | | | | | | | | | | | |
| 62 | 17,0 | 17,3 | 17,8 | 18,0 | 18,3 | 16,6 | 16,9 | 16,7 | 17,0 | 15,5 | 15,8 | 15,9 | 16,2 | 16,8 | 16,3 | 16,6 | 14,6 | 14,9 | 62 | | | | | | | | | | | | | |
| 66 | 14,1 | 14,3 | 14,8 | 15,1 | 15,3 | 13,5 | 13,7 | 13,8 | 14,0 | 12,3 | 12,6 | 13,0 | 13,2 | 13,7 | 13,3 | 13,6 | 11,4 | 11,7 | 66 | | | | | | | | | | | | | |
| 70 | 11,5 | 11,8 | 12,1 | 12,5 | 12,7 | 10,7 | 11,0 | 11,2 | 11,4 | 9,6 | 9,9 | 10,4 | 10,6 | 11,1 | 10,8 | 11,0 | 8,6 | 8,9 | 70 | | | | | | | | | | | | | |
| 74 | 9,3 | 9,5 | 9,8 | 10,3 | 10,5 | 8,3 | 8,5 | 9,0 | 9,2 | 7,2 | 7,4 | 8,1 | 8,4 | 8,7 | 8,5 | 8,7 | 6,2 | 6,5 | 74 | | | | | | | | | | | | | |
| 77 | 7,8 | 8,0 | 8,2 | 8,8 | 9,0 | 6,7 | 6,9 | 7,5 | 7,6 | 5,5 | 5,7 | 6,6 | 6,8 | 7,1 | 7,0 | 7,2 | 4,6 | 4,8 | 77 | | | | | | | | | | | | | |
| 78 | 7,3 | 7,5 | - | 8,3 | 8,5 | 6,2 | 6,4 | 7,0 | 7,1 | 5,0 | 5,2 | 6,2 | 6,3 | 6,7 | 6,5 | 6,7 | 4,1 | 4,3 | 78 | | | | | | | | | | | | | |
| 79 | 6,9 | 7,0 | - | 7,8 | 8,0 | 5,7 | 5,9 | 6,5 | 6,7 | 4,5 | 4,7 | 5,7 | 5,8 | 6,2 | 6,0 | 6,2 | 3,6 | 3,8 | 79 | | | | | | | | | | | | | |
| 81 | 6,0 | 6,1 | - | 7,0 | 7,1 | 4,7 | 4,9 | 5,6 | 5,8 | 3,6 | 3,8 | 4,8 | 5,0 | 5,3 | 5,2 | 5,3 | - | - | 81 | | | | | | | | | | | | | |
| 82 | 5,6 | 5,7 | - | 6,6 | 6,7 | 4,3 | 4,5 | 5,2 | 5,4 | - | - | 4,4 | 4,6 | - | 4,8 | 4,9 | - | - | 82 | | | | | | | | | | | | | |
| 83 | 5,2 | 5,3 | - | 6,2 | 6,3 | 3,9 | 4,0 | 4,8 | 5,0 | - | - | 4,0 | 4,1 | - | 4,4 | 4,5 | - | - | 83 | | | | | | | | | | | | | |
| 84 | 4,8 | 4,9 | - | 5,8 | 5,9 | - | 3,6 | 4,4 | 4,6 | - | - | 3,6 | 3,7 | - | 4,0 | 4,1 | - | - | 84 | | | | | | | | | | | | | |
| 85 | 4,4 | 4,5 | - | 5,4 | 5,5 | - | - | 4,0 | 4,2 | - | - | - | - | - | 3,6 | 3,7 | - | - | 85 | | | | | | | | | | | | | |
| 86 | 4,0 | 4,1 | - | 5,0 | 5,1 | - | - | 3,6 | 3,8 | - | - | - | - | - | - | - | - | - | 86 | | | | | | | | | | | | | |
| 87 | 3,7 | 3,8 | - | 4,6 | - | - | - | - | - | - | - | - | - | - | - | - | - | - | 87 | | | | | | | | | | | | | |
| 90 | - | - | - | 3,7 | - | - | - | - | - | - | - | - | - | - | - | - | - | - | 90 | | | | | | | | | | | | | |

45 t 85 t 125 t 165 t 185 t 205 t 225 t

0 t 30 t 50 t

| 12 m 8,40 m 9.8 m/s 360° ISO | | | | | | | | | | | | | | | | | |
|--|-------|---------|-------|---------|-------|---------|------|---------|-------|---------|-------|---------|-------|-------|-------|-----|-----|
| 99 m | | | | 102 m | | | | 105 m | | | | | | | | | |
| LH+LF_3 | | LH+LF_4 | | LH+LF_1 | | LH+LF_3 | | LH+LF_4 | | LH+LF_3 | | LH+LF_4 | | | | | |
| 12 m | | | | | | | | | | | | | | | | | |
| 15° | | 20° | | 15° | | 20° | | 15° | | 20° | | 15° | | 20° | | 15° | 20° |
| m | t | t | t | t | t | t | t | t | t | t | t | t | t | t | t | t | m |
| 15 | 118,0 | - | 145,0 | - | 103,0 | - | - | 115,0 | - | 140,0 | - | 110,0 | - | 129,0 | - | - | 15 |
| 16 | 116,0 | 112,0 | 139,0 | 136,0 | 102,0 | 94,0 | - | 113,0 | 110,0 | 135,0 | 133,0 | 108,0 | 106,0 | 127,0 | 117,0 | - | 16 |
| 18 | 112,0 | 107,0 | 128,0 | 126,0 | 99,5 | 91,5 | 76,0 | 111,0 | 108,0 | 125,0 | 124,0 | 106,0 | 104,0 | 123,0 | 113,0 | - | 18 |
| 20 | 103,0 | 103,0 | 114,0 | 115,0 | 97,0 | 88,5 | 74,0 | 101,0 | 102,0 | 112,0 | 113,0 | 99,5 | 100,0 | 112,0 | 110,0 | - | 20 |
| 22 | 93,0 | 94,5 | 102,0 | 103,0 | 91,5 | 86,0 | 72,5 | 91,5 | 92,5 | 100,0 | 102,0 | 89,5 | 90,5 | 100,0 | 102,0 | - | 22 |
| 24 | 84,5 | 85,5 | 92,0 | 93,5 | 83,0 | 83,5 | 70,5 | 83,0 | 84,0 | 90,5 | 92,0 | 81,0 | 82,0 | 91,0 | 92,0 | - | 24 |
| 26 | 77,0 | 78,0 | 83,5 | 84,5 | 75,5 | 76,5 | 68,5 | 75,5 | 76,5 | 82,0 | 83,0 | 74,0 | 75,0 | 82,5 | 83,5 | - | 26 |
| 28 | 70,5 | 71,0 | 76,0 | 77,0 | 69,0 | 69,5 | 66,5 | 69,0 | 70,0 | 74,5 | 75,5 | 67,5 | 68,5 | 75,0 | 76,0 | - | 28 |
| 30 | 64,5 | 65,5 | 69,0 | 70,0 | 63,0 | 64,0 | 65,0 | 63,0 | 64,0 | 68,0 | 69,0 | 61,5 | 62,5 | 68,5 | 69,5 | - | 30 |
| 34 | 54,5 | 55,5 | 58,0 | 59,0 | 53,5 | 54,0 | 55,5 | 53,5 | 54,0 | 56,5 | 57,5 | 52,0 | 52,5 | 57,5 | 58,5 | - | 34 |
| 38 | 46,8 | 47,4 | 48,7 | 49,4 | 45,5 | 46,2 | 47,3 | 45,6 | 46,2 | 47,9 | 48,6 | 44,3 | 44,9 | 48,9 | 49,6 | - | 38 |
| 42 | 39,5 | 40,1 | 39,7 | 40,4 | 38,8 | 39,4 | 40,5 | 38,8 | 39,4 | 39,0 | 39,8 | 37,7 | 38,3 | 40,2 | 40,9 | - | 42 |
| 46 | 32,7 | 33,2 | 32,4 | 33,0 | 31,9 | 32,5 | 33,5 | 32,0 | 32,5 | 31,7 | 32,4 | 31,1 | 31,7 | 32,9 | 33,5 | - | 46 |
| 50 | 27,1 | 27,5 | 26,4 | 27,0 | 26,3 | 26,8 | 27,7 | 26,4 | 26,8 | 25,7 | 26,3 | 25,5 | 26,0 | 26,9 | 27,4 | - | 50 |
| 54 | 22,4 | 22,8 | 21,4 | 21,9 | 21,6 | 22,0 | 22,8 | 21,7 | 22,1 | 20,7 | 21,2 | 20,8 | 21,2 | 21,9 | 22,4 | - | 54 |
| 58 | 18,4 | 18,8 | 17,1 | 17,5 | 17,6 | 18,0 | 18,7 | 17,7 | 18,0 | 16,4 | 16,8 | 16,8 | 17,2 | 17,6 | 18,0 | - | 58 |
| 62 | 15,0 | 15,3 | 13,4 | 13,8 | 14,2 | 14,5 | 15,1 | 14,2 | 14,6 | 12,7 | 13,1 | 13,3 | 13,7 | 13,9 | 14,3 | - | 62 |
| 66 | 12,0 | 12,3 | 10,3 | 10,6 | 11,2 | 11,5 | 12,1 | 11,3 | 11,6 | 9,5 | 9,9 | 10,4 | 10,7 | 10,7 | 11,1 | - | 66 |
| 70 | 9,4 | 9,7 | 7,5 | 7,8 | 8,7 | 8,9 | 9,4 | 8,7 | 9,0 | 6,7 | 7,1 | 7,8 | 8,1 | 8,0 | 8,3 | - | 70 |
| 74 | 7,2 | 7,4 | 5,1 | 5,3 | 6,4 | 6,6 | 7,0 | 6,4 | 6,6 | 4,3 | 4,6 | 5,5 | 5,7 | 5,5 | 5,8 | - | 74 |
| 75 | 6,6 | 6,9 | 4,5 | 4,7 | 5,9 | 6,1 | 6,5 | 5,9 | 6,1 | 3,7 | 4,0 | 4,9 | 5,2 | 4,9 | 5,2 | - | 75 |
| 76 | 6,1 | 6,4 | 3,9 | 4,2 | 5,4 | 5,6 | 6,0 | 5,4 | 5,6 | - | - | 4,4 | 4,7 | 4,4 | 4,7 | - | 76 |
| 77 | 5,6 | 5,9 | - | 3,7 | 4,9 | 5,1 | 5,5 | 4,9 | 5,1 | - | - | 3,9 | 4,2 | 3,9 | 4,1 | - | 77 |
| 78 | 5,1 | 5,4 | - | - | 4,4 | 4,6 | 5,0 | 4,4 | 4,6 | - | - | - | 3,7 | - | 3,6 | - | 78 |
| 79 | 4,6 | 4,9 | - | - | 3,9 | 4,1 | 4,5 | 3,9 | 4,1 | - | - | - | - | - | - | - | 79 |
| 80 | 4,2 | 4,4 | - | - | - | 3,7 | 4,0 | - | 3,7 | - | - | - | - | - | - | - | 80 |
| 81 | 3,8 | 3,9 | - | - | - | - | 3,5 | - | - | - | - | - | - | - | - | - | 81 |
| 82 | - | 3,5 | - | - | - | - | - | - | - | - | - | - | - | - | - | - | 82 |

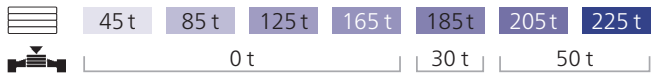

| 12 m 8,40 m 9.8 m/s 360° ISO | | | | | | | | | | | | | | |
|--|------|------|------|-------|-------|-------|-------|------|------|------|------|------|---|----|
| 108 m 111 m 114 m | | | | | | | | | | | | | | |
| LH+LF_1 LH+LF_3 LH+LF_4 LH+LF_3 LH+LF_1 | | | | | | | | | | | | | | |
| 12 m | | | | | | | | | | | | | | |
| 15° 20° 30° 15° 20° 15° 20° 15° 20° 15° 20° 30° | | | | | | | | | | | | | | |
| m | t | t | t | t | t | t | t | t | t | t | t | t | t | m |
| 15 | 96,5 | - | - | 105,0 | - | 124,0 | - | - | - | - | - | - | - | 15 |
| 16 | 95,5 | 88,0 | - | 104,0 | 101,0 | 122,0 | - | 99,5 | - | 89,0 | - | - | - | 16 |
| 17 | 94,2 | 86,7 | - | 103,0 | 100,2 | 120,0 | 113,0 | 98,2 | 96,5 | 87,7 | 84,0 | - | - | 17 |
| 18 | 93,0 | 85,5 | 71,5 | 102,0 | 99,5 | 118,0 | 111,0 | 97,0 | 95,5 | 86,5 | 83,0 | - | - | 18 |
| 19 | 91,7 | 84,5 | 70,7 | 99,7 | 98,5 | 116,0 | 110,0 | 95,7 | 94,7 | 85,5 | 82,0 | 69,0 | - | 19 |
| 20 | 90,5 | 83,5 | 70,0 | 97,5 | 97,5 | 110,0 | 108,0 | 94,5 | 94,0 | 84,5 | 81,0 | 68,5 | - | 20 |
| 22 | 88,0 | 81,0 | 68,0 | 87,5 | 89,0 | 99,0 | 100,0 | 86,0 | 87,0 | 82,0 | 79,0 | 67,0 | - | 22 |
| 24 | 79,5 | 78,5 | 66,0 | 79,5 | 80,5 | 89,5 | 90,5 | 77,5 | 78,5 | 76,0 | 77,0 | 65,5 | - | 24 |
| 26 | 72,0 | 73,0 | 64,5 | 72,0 | 73,0 | 81,0 | 82,0 | 70,5 | 71,5 | 69,0 | 70,0 | 64,0 | - | 26 |
| 28 | 66,0 | 67,0 | 62,5 | 66,0 | 66,5 | 73,5 | 74,5 | 64,0 | 65,0 | 63,0 | 63,5 | 62,5 | - | 28 |
| 30 | 60,0 | 61,0 | 61,0 | 60,0 | 61,0 | 67,0 | 68,0 | 58,5 | 59,5 | 57,5 | 58,0 | 60,0 | - | 30 |
| 34 | 50,5 | 51,5 | 53,0 | 50,5 | 51,5 | 56,5 | 57,0 | 49,4 | 50,0 | 48,1 | 48,9 | 50,0 | - | 34 |
| 38 | 43,1 | 43,7 | 45,0 | 42,9 | 43,6 | 47,7 | 48,5 | 41,6 | 42,3 | 40,5 | 41,2 | 42,5 | - | 38 |
| 42 | 36,6 | 37,2 | 38,3 | 36,5 | 37,1 | 39,5 | 40,2 | 35,2 | 35,8 | 34,1 | 34,7 | 35,9 | - | 42 |
| 46 | 30,4 | 31,0 | 32,0 | 30,3 | 30,9 | 32,2 | 32,8 | 29,4 | 30,0 | 28,7 | 29,3 | 30,3 | - | 46 |
| 50 | 24,7 | 25,3 | 26,2 | 24,6 | 25,1 | 26,2 | 26,7 | 23,8 | 24,3 | 23,0 | 23,6 | 24,6 | - | 50 |
| 54 | 20,0 | 20,5 | 21,3 | 19,9 | 20,4 | 21,1 | 21,6 | 19,0 | 19,5 | 18,3 | 18,8 | 19,7 | - | 54 |
| 58 | 16,0 | 16,4 | 17,2 | 15,9 | 16,3 | 16,8 | 17,3 | 15,0 | 15,4 | 14,3 | 14,7 | 15,5 | - | 58 |
| 62 | 12,6 | 13,0 | 13,6 | 12,4 | 12,8 | 13,1 | 13,6 | 11,5 | 11,9 | 10,8 | 11,2 | 11,9 | - | 62 |
| 66 | 9,6 | 9,9 | 10,5 | 9,5 | 9,8 | 10,0 | 10,3 | 8,5 | 8,9 | 7,8 | 8,2 | 8,8 | - | 66 |
| 70 | 7,0 | 7,3 | 7,8 | 6,9 | 7,2 | 7,2 | 7,5 | 5,9 | 6,2 | 5,2 | 5,5 | 6,1 | - | 70 |
| 72 | 5,8 | 6,1 | 6,6 | 5,7 | 6,0 | 5,9 | 6,2 | 4,7 | 5,0 | 4,0 | 4,3 | 4,9 | - | 72 |
| 73 | 5,2 | 5,5 | 6,0 | 5,1 | 5,4 | 5,3 | 5,6 | 4,1 | 4,4 | - | 3,7 | 4,3 | - | 73 |
| 74 | 4,7 | 5,0 | 5,4 | 4,6 | 4,8 | 4,7 | 5,0 | 3,6 | 3,9 | - | - | 3,7 | - | 74 |
| 76 | 3,7 | 3,9 | 4,3 | 3,5 | 3,8 | 3,6 | 3,9 | - | - | - | - | - | - | 76 |
| 77 | - | - | 3,8 | - | - | - | - | - | - | - | - | - | - | 77 |

45 t
85 t
125 t
165 t
185 t
205 t
225 t

0 t
30 t
50 t

| 18 m | | 8,40 m | | | | 9.8 m/s | | | | 360° | | | | ISO |
|------|-------|--------|-------|------|-------|---------|-------|------|-------|------|-------|---------|---|-----|
| 84 m | | 87 m | | 90 m | | 93 m | | 96 m | | 99 m | | LH+LF_4 | | |
| 18 m | | | | | | | | | | | | | | |
| 15° | | 20° | | 15° | | 20° | | 15° | | 20° | | 15° | | |
| m | t | t | t | t | t | t | t | t | t | t | t | t | t | m |
| 15 | 126,0 | - | - | - | - | - | - | - | - | - | - | - | - | 15 |
| 16 | 123,0 | - | 123,0 | - | 124,0 | - | 124,0 | - | 125,0 | - | - | - | - | 16 |
| 17 | 119,0 | 92,0 | 120,0 | 92,5 | 121,0 | - | 121,0 | - | 122,0 | - | - | 121,0 | - | 17 |
| 18 | 116,0 | 90,0 | 117,0 | 90,5 | 118,0 | 90,5 | 118,0 | 91,0 | 119,0 | 91,5 | 117,0 | 91,5 | - | 18 |
| 20 | 110,0 | 86,5 | 111,0 | 87,0 | 112,0 | 87,0 | 113,0 | 87,5 | 113,0 | 88,0 | 110,0 | 88,5 | - | 20 |
| 22 | 105,0 | 83,0 | 106,0 | 83,5 | 107,0 | 84,0 | 106,0 | 84,5 | 104,0 | 85,0 | 102,0 | 85,5 | - | 22 |
| 24 | 100,0 | 80,0 | 100,0 | 80,5 | 98,5 | 81,0 | 96,5 | 81,5 | 94,5 | 82,0 | 92,5 | 82,5 | - | 24 |
| 26 | 93,0 | 77,5 | 91,0 | 78,0 | 89,5 | 78,5 | 87,5 | 79,0 | 86,0 | 79,0 | 84,0 | 79,5 | - | 26 |
| 28 | 85,0 | 75,0 | 83,0 | 75,5 | 82,0 | 76,0 | 80,0 | 76,0 | 78,5 | 76,0 | 76,5 | 76,0 | - | 28 |
| 30 | 78,0 | 72,5 | 76,5 | 73,0 | 75,0 | 73,5 | 73,0 | 73,5 | 71,5 | 73,0 | 70,0 | 71,5 | - | 30 |
| 34 | 65,0 | 66,0 | 64,5 | 65,5 | 63,5 | 64,5 | 62,0 | 63,0 | 60,5 | 61,5 | 59,0 | 60,0 | - | 34 |
| 38 | 54,0 | 55,0 | 53,5 | 54,5 | 53,0 | 54,0 | 52,0 | 53,0 | 51,5 | 52,5 | 50,0 | 51,0 | - | 38 |
| 42 | 45,9 | 46,6 | 45,1 | 45,8 | 44,5 | 45,3 | 43,7 | 44,6 | 43,0 | 43,9 | 42,1 | 43,1 | - | 42 |
| 46 | 39,0 | 39,7 | 38,1 | 38,9 | 37,4 | 38,2 | 36,4 | 37,3 | 35,6 | 36,5 | 34,6 | 35,5 | - | 46 |
| 50 | 33,0 | 33,7 | 32,0 | 32,7 | 31,3 | 32,0 | 30,3 | 31,1 | 29,5 | 30,3 | 28,5 | 29,3 | - | 50 |
| 54 | 27,9 | 28,5 | 26,9 | 27,5 | 26,2 | 26,9 | 25,2 | 25,9 | 24,4 | 25,1 | 23,3 | 24,1 | - | 54 |
| 58 | 23,6 | 24,1 | 22,6 | 23,1 | 21,9 | 22,5 | 20,9 | 21,5 | 20,0 | 20,6 | 19,0 | 19,6 | - | 58 |
| 62 | 19,9 | 20,4 | 18,9 | 19,4 | 18,2 | 18,7 | 17,1 | 17,7 | 16,3 | 16,8 | 15,2 | 15,8 | - | 62 |
| 66 | 16,7 | 17,1 | 15,7 | 16,1 | 14,9 | 15,4 | 13,9 | 14,4 | 13,0 | 13,5 | 11,9 | 12,5 | - | 66 |
| 70 | 13,9 | 14,3 | 12,8 | 13,2 | 12,1 | 12,5 | 11,1 | 11,5 | 10,2 | 10,6 | 9,1 | 9,6 | - | 70 |
| 74 | 11,4 | 11,7 | 10,4 | 10,7 | 9,6 | 10,0 | 8,6 | 8,9 | 7,7 | 8,1 | 6,6 | 7,0 | - | 74 |
| 78 | 9,2 | 9,5 | 8,2 | 8,5 | 7,4 | 7,7 | 6,4 | 6,7 | 5,5 | 5,8 | 4,3 | 4,7 | - | 78 |
| 79 | 8,7 | 9,0 | 7,7 | 8,0 | 6,9 | 7,2 | 5,8 | 6,2 | 4,9 | 5,3 | - | 4,2 | - | 79 |
| 80 | 8,2 | 8,5 | 7,2 | 7,5 | 6,4 | 6,7 | 5,3 | 5,7 | 4,4 | 4,8 | - | 3,7 | - | 80 |
| 81 | 7,7 | 8,0 | 6,7 | 7,0 | 5,9 | 6,2 | 4,8 | 5,2 | 3,9 | 4,3 | - | - | - | 81 |
| 82 | 7,3 | 7,5 | 6,2 | 6,5 | 5,5 | 5,7 | 4,4 | 4,7 | - | 3,8 | - | - | - | 82 |
| 83 | 6,8 | 7,0 | 5,8 | 6,0 | 5,0 | 5,2 | 3,9 | 4,2 | - | - | - | - | - | 83 |
| 84 | 6,4 | 6,6 | 5,3 | 5,5 | 4,6 | 4,8 | - | 3,8 | - | - | - | - | - | 84 |
| 86 | 5,6 | 5,7 | 4,5 | 4,7 | 3,7 | 3,9 | - | - | - | - | - | - | - | 86 |
| 87 | 5,2 | 5,3 | 4,1 | 4,2 | - | 3,5 | - | - | - | - | - | - | - | 87 |
| 88 | 4,8 | 4,9 | 3,7 | 3,8 | - | - | - | - | - | - | - | - | - | 88 |
| 90 | 4,0 | - | - | - | - | - | - | - | - | - | - | - | - | 90 |
| 91 | 3,6 | - | - | - | - | - | - | - | - | - | - | - | - | 91 |



| m | t | t | t | t | t | t | t | t | t | t | t | t | t | t | t | t | t | m |
|----|------|------|------|------|------|------|------|------|------|------|------|------|------|------|------|------|------|----|
| 14 | 86,5 | - | - | - | - | - | - | - | - | - | - | - | - | - | - | - | - | 14 |
| 15 | 83,2 | - | - | 85,0 | - | - | 86,5 | - | - | - | - | - | - | - | - | - | - | 15 |
| 16 | 80,0 | 63,5 | - | 82,0 | - | - | 83,5 | - | - | 84,5 | - | - | 85,0 | - | - | - | - | 16 |
| 17 | 77,0 | 61,5 | - | 79,0 | 62,5 | - | 80,7 | 63,5 | - | 82,0 | - | - | 82,5 | - | - | 80,5 | - | 17 |
| 18 | 74,0 | 59,5 | - | 76,0 | 60,5 | - | 78,0 | 61,5 | - | 79,5 | 62,5 | - | 80,0 | 63,0 | - | 79,0 | - | 18 |
| 19 | 71,5 | 57,7 | - | 73,7 | 59,0 | - | 75,7 | 60,0 | - | 77,2 | 61,0 | - | 78,0 | 61,5 | - | 77,2 | 62,0 | 19 |
| 20 | 69,0 | 56,0 | 38,3 | 71,5 | 57,5 | 38,5 | 73,5 | 58,5 | - | 75,0 | 59,5 | - | 76,0 | 60,0 | - | 75,5 | 60,5 | 20 |
| 21 | 66,7 | 54,5 | 37,5 | 69,2 | 56,0 | 37,7 | 71,2 | 57,0 | 38,0 | 73,0 | 58,0 | 38,1 | 74,0 | 58,7 | - | 73,7 | 59,2 | 21 |
| 22 | 64,5 | 53,0 | 36,7 | 67,0 | 54,5 | 37,0 | 69,0 | 55,5 | 37,2 | 71,0 | 56,5 | 37,4 | 72,0 | 57,5 | 37,5 | 72,0 | 58,0 | 22 |
| 24 | 61,0 | 50,0 | 35,2 | 63,0 | 51,5 | 35,6 | 65,0 | 53,0 | 35,9 | 67,0 | 54,0 | 36,1 | 69,0 | 55,0 | 36,3 | 69,0 | 55,5 | 24 |
| 26 | 57,5 | 47,8 | 33,7 | 59,5 | 49,3 | 34,3 | 62,0 | 50,5 | 34,7 | 64,0 | 51,5 | 35,0 | 65,5 | 52,5 | 35,2 | 66,0 | 53,5 | 26 |
| 28 | 54,5 | 45,5 | 32,4 | 56,5 | 47,0 | 33,1 | 58,5 | 48,4 | 33,5 | 60,5 | 49,6 | 33,9 | 62,5 | 50,5 | 34,1 | 63,0 | 51,5 | 28 |
| 30 | 51,5 | 43,5 | 31,2 | 54,0 | 45,0 | 31,9 | 56,0 | 46,4 | 32,4 | 58,0 | 47,6 | 32,8 | 59,5 | 48,8 | 33,1 | 60,5 | 49,8 | 30 |
| 34 | 47,0 | 39,9 | 29,1 | 49,2 | 41,4 | 29,8 | 51,0 | 42,8 | 30,5 | 53,0 | 44,1 | 30,9 | 55,0 | 45,3 | 31,3 | 56,0 | 46,4 | 34 |
| 38 | 43,1 | 36,9 | 27,3 | 45,2 | 38,4 | 28,1 | 47,2 | 39,8 | 28,7 | 49,1 | 41,1 | 29,3 | 50,5 | 42,3 | 29,7 | 51,5 | 43,4 | 38 |
| 42 | 39,8 | 34,4 | 25,8 | 41,8 | 35,8 | 26,5 | 43,7 | 37,2 | 27,2 | 45,6 | 38,5 | 27,8 | 47,3 | 39,6 | 28,3 | 46,2 | 40,7 | 42 |
| 46 | 37,0 | 32,2 | 24,5 | 38,9 | 33,6 | 25,2 | 40,8 | 34,9 | 25,9 | 41,7 | 36,2 | 26,5 | 40,9 | 37,4 | 27,1 | 39,7 | 38,4 | 46 |
| 50 | 34,6 | 30,3 | 23,4 | 36,4 | 31,7 | 24,1 | 37,7 | 33,0 | 24,7 | 36,4 | 34,2 | 25,3 | 35,6 | 35,3 | 25,9 | 34,3 | 34,9 | 50 |
| 54 | 32,6 | 28,8 | 22,5 | 34,3 | 30,1 | 23,1 | 33,2 | 31,3 | 23,7 | 32,0 | 32,4 | 24,3 | 31,1 | 31,6 | 24,9 | 29,7 | 30,4 | 54 |
| 58 | 30,8 | 27,5 | 21,8 | 30,7 | 28,6 | 22,3 | 29,5 | 29,8 | 22,9 | 28,2 | 28,6 | 23,5 | 27,2 | 27,7 | 24,0 | 25,6 | 26,2 | 58 |
| 59 | 30,4 | 27,2 | 21,6 | 29,9 | 28,3 | 22,1 | 28,6 | 28,9 | 22,7 | 27,3 | 27,7 | 23,3 | 26,3 | 26,8 | 23,8 | 24,7 | 25,3 | 59 |
| 62 | 28,6 | 26,4 | - | 27,5 | 27,4 | 21,7 | 26,2 | 26,5 | 22,2 | 24,8 | 25,2 | 22,7 | 23,7 | 24,1 | 23,2 | 22,1 | 22,6 | 62 |
| 63 | 27,9 | 26,1 | - | 26,8 | 26,7 | 21,5 | 25,4 | 25,7 | 22,0 | 24,0 | 24,4 | 22,5 | 22,9 | 23,3 | 23,0 | 21,3 | 21,8 | 63 |
| 64 | 27,2 | 25,9 | - | 26,1 | 26,1 | - | 24,7 | 25,0 | 21,9 | 23,2 | 23,6 | 22,3 | 22,1 | 22,5 | 22,8 | 20,6 | 21,0 | 64 |
| 66 | 25,9 | - | - | 24,7 | 24,9 | - | 23,3 | 23,6 | 21,6 | 21,7 | 22,1 | 22,0 | 20,6 | 21,0 | 21,7 | 19,1 | 19,5 | 66 |
| 67 | - | - | - | 24,0 | 24,2 | - | 22,6 | 22,9 | 21,5 | 21,0 | 21,4 | 21,4 | 19,9 | 20,3 | 21,0 | 18,4 | 18,8 | 67 |
| 69 | - | - | - | 22,7 | 22,9 | - | 21,3 | 21,5 | - | 19,7 | 20,0 | 20,4 | 18,6 | 18,9 | 19,6 | 17,0 | 17,4 | 69 |
| 70 | - | - | - | 22,1 | - | - | 20,7 | 20,9 | - | 19,1 | 19,4 | 19,9 | 18,0 | 18,3 | 18,9 | 16,4 | 16,8 | 70 |
| 72 | - | - | - | 21,0 | - | - | 19,5 | 19,7 | - | 17,9 | 18,2 | 18,6 | 16,8 | 17,1 | 17,6 | 15,2 | 15,6 | 72 |
| 74 | - | - | - | - | - | - | 18,4 | 18,5 | - | 16,8 | 17,0 | - | 15,7 | 15,9 | 16,4 | 14,1 | 14,4 | 74 |
| 76 | - | - | - | - | - | - | 17,3 | - | - | 15,7 | 15,9 | - | 14,6 | 14,8 | 15,3 | 13,0 | 13,3 | 76 |
| 77 | - | - | - | - | - | - | 16,8 | - | - | 15,2 | 15,4 | - | 14,1 | 14,3 | - | 12,5 | 12,8 | 77 |
| 78 | - | - | - | - | - | - | - | - | - | 14,7 | 14,9 | - | 13,6 | 13,8 | - | 12,0 | 12,3 | 78 |
| 79 | - | - | - | - | - | - | - | - | - | 14,2 | 14,4 | - | 13,1 | 13,3 | - | 11,5 | 11,8 | 79 |
| 80 | - | - | - | - | - | - | - | - | - | 13,8 | - | - | 12,6 | 12,8 | - | 11,0 | 11,3 | 80 |
| 82 | - | - | - | - | - | - | - | - | - | 12,9 | - | - | 11,7 | 11,9 | - | 10,1 | 10,4 | 82 |
| 84 | - | - | - | - | - | - | - | - | - | - | - | - | 10,9 | 11,1 | - | 9,2 | 9,5 | 84 |
| 86 | - | - | - | - | - | - | - | - | - | - | - | - | 10,1 | - | - | 8,4 | 8,7 | 86 |
| 87 | - | - | - | - | - | - | - | - | - | - | - | - | 9,7 | - | - | 8,0 | 8,3 | 87 |
| 89 | - | - | - | - | - | - | - | - | - | - | - | - | - | - | - | 7,2 | 7,5 | 89 |
| 90 | - | - | - | - | - | - | - | - | - | - | - | - | - | - | - | 6,9 | - | 90 |
| 92 | - | - | - | - | - | - | - | - | - | - | - | - | - | - | - | 6,2 | - | 92 |



| m | t | t | t | t | t | t | t | t | t | t | t | t | t | t | t | m |
|----|------|------|------|------|------|------|------|------|------|------|------|------|------|------|------|----|
| 17 | 80,5 | - | - | - | - | - | - | - | - | - | - | - | - | - | - | 17 |
| 18 | 79,0 | - | - | 74,0 | - | - | 67,0 | - | - | - | - | - | - | - | - | 18 |
| 19 | 78,0 | 62,0 | - | 73,0 | - | - | 66,2 | - | - | 62,0 | - | - | 58,5 | - | - | 19 |
| 20 | 77,0 | 60,5 | - | 72,0 | 60,5 | - | 65,5 | 56,5 | - | 61,0 | - | - | 57,5 | - | - | 20 |
| 21 | 75,5 | 59,5 | - | 71,2 | 59,5 | - | 64,5 | 55,7 | - | 60,2 | 52,5 | - | 56,5 | 49,5 | - | 21 |
| 22 | 74,0 | 58,5 | - | 70,5 | 58,5 | - | 63,5 | 55,0 | - | 59,5 | 51,5 | - | 55,5 | 48,8 | - | 22 |
| 23 | 72,2 | 57,2 | 37,0 | 69,5 | 57,5 | 37,0 | 62,5 | 54,5 | - | 58,5 | 51,0 | - | 54,7 | 48,1 | - | 23 |
| 24 | 70,5 | 56,0 | 36,5 | 68,5 | 56,5 | 36,5 | 61,5 | 54,0 | 36,4 | 57,5 | 50,5 | 36,3 | 54,0 | 47,4 | - | 24 |
| 25 | 69,0 | 55,0 | 36,0 | 67,5 | 55,5 | 36,0 | 60,7 | 53,2 | 35,9 | 56,7 | 49,8 | 35,8 | 53,2 | 46,7 | 35,6 | 25 |
| 26 | 67,5 | 54,0 | 35,5 | 66,5 | 54,5 | 35,5 | 60,0 | 52,5 | 35,5 | 56,0 | 49,2 | 35,4 | 52,5 | 46,1 | 35,2 | 26 |
| 28 | 65,0 | 52,5 | 34,5 | 64,5 | 52,5 | 34,6 | 58,0 | 51,0 | 34,6 | 54,0 | 47,8 | 34,6 | 50,5 | 44,8 | 34,4 | 28 |
| 30 | 62,5 | 50,5 | 33,7 | 62,5 | 51,0 | 33,8 | 56,0 | 49,9 | 33,8 | 52,0 | 46,4 | 33,8 | 49,2 | 43,5 | 33,6 | 30 |
| 34 | 58,0 | 47,4 | 32,0 | 58,5 | 48,2 | 32,2 | 53,0 | 47,2 | 32,3 | 49,1 | 43,8 | 32,4 | 46,1 | 41,1 | 32,2 | 34 |
| 38 | 53,5 | 44,4 | 30,5 | 51,0 | 45,3 | 30,8 | 49,4 | 44,8 | 30,9 | 46,0 | 41,4 | 31,1 | 43,2 | 38,7 | 31,0 | 38 |
| 42 | 45,8 | 41,8 | 29,2 | 44,5 | 42,7 | 29,5 | 42,7 | 42,4 | 29,7 | 40,4 | 39,1 | 29,9 | 38,3 | 36,6 | 29,8 | 42 |
| 46 | 39,2 | 39,5 | 28,0 | 38,1 | 38,9 | 28,3 | 37,1 | 38,0 | 28,5 | 34,9 | 35,9 | 28,7 | 32,8 | 33,8 | 28,7 | 46 |
| 50 | 33,9 | 34,5 | 26,9 | 32,6 | 33,4 | 27,3 | 31,6 | 32,5 | 27,5 | 30,2 | 31,1 | 27,7 | 28,1 | 29,1 | 27,7 | 50 |
| 54 | 29,2 | 29,9 | 25,9 | 27,7 | 28,5 | 26,3 | 26,8 | 27,6 | 26,6 | 25,3 | 26,2 | 26,8 | 23,9 | 24,8 | 26,5 | 54 |
| 58 | 25,1 | 25,7 | 24,9 | 23,6 | 24,3 | 25,4 | 22,6 | 23,3 | 24,6 | 21,2 | 21,9 | 23,3 | 19,8 | 20,6 | 22,1 | 58 |
| 62 | 21,6 | 22,1 | 23,1 | 20,1 | 20,7 | 21,8 | 19,1 | 19,7 | 20,9 | 17,6 | 18,3 | 19,6 | 16,2 | 16,9 | 18,3 | 62 |
| 66 | 18,5 | 19,0 | 19,9 | 17,0 | 17,5 | 18,5 | 16,0 | 16,6 | 17,6 | 14,5 | 15,1 | 16,3 | 13,0 | 13,7 | 15,0 | 66 |
| 70 | 15,9 | 16,3 | 17,0 | 14,3 | 14,8 | 15,6 | 13,3 | 13,8 | 14,8 | 11,8 | 12,3 | 13,4 | 10,3 | 10,9 | 12,1 | 70 |
| 74 | 13,5 | 13,9 | 14,5 | 11,9 | 12,4 | 13,1 | 10,9 | 11,4 | 12,2 | 9,4 | 9,9 | 10,8 | 7,9 | 8,5 | 9,5 | 74 |
| 78 | 11,4 | 11,7 | 12,3 | 9,8 | 10,2 | 10,9 | 8,8 | 9,2 | 10,0 | 7,2 | 7,7 | 8,5 | 5,7 | 6,3 | 7,2 | 78 |
| 82 | 9,5 | 9,8 | 10,3 | 7,9 | 8,3 | 8,9 | 6,9 | 7,3 | 7,9 | 5,3 | 5,8 | 6,5 | 3,8 | 4,3 | 5,1 | 82 |
| 83 | 9,1 | 9,3 | 9,8 | 7,5 | 7,8 | 8,4 | 6,4 | 6,8 | 7,4 | 4,8 | 5,3 | 6,0 | - | 3,8 | 4,6 | 83 |
| 84 | 8,7 | 8,9 | 9,4 | 7,1 | 7,4 | 7,9 | 6,0 | 6,3 | 7,0 | 4,4 | 4,9 | 5,6 | - | - | 4,1 | 84 |
| 85 | 8,3 | 8,5 | - | 6,7 | 6,9 | 7,4 | 5,6 | 5,9 | 6,6 | 4,0 | 4,4 | 5,1 | - | - | 3,7 | 85 |
| 86 | 7,9 | 8,1 | - | 6,2 | 6,5 | 7,0 | 5,2 | 5,5 | 6,1 | 3,6 | 4,0 | 4,7 | - | - | - | 86 |
| 87 | 7,5 | 7,7 | - | 5,8 | 6,1 | 6,6 | 4,8 | 5,1 | 5,7 | - | 3,6 | 4,2 | - | - | - | 87 |
| 88 | 7,1 | 7,3 | - | 5,4 | 5,7 | 6,2 | 4,4 | 4,7 | 5,3 | - | - | 3,8 | - | - | - | 88 |
| 89 | 6,7 | 6,9 | - | 5,0 | 5,3 | 5,8 | 4,0 | 4,3 | 4,9 | - | - | - | - | - | - | 89 |
| 90 | 6,3 | 6,6 | - | 4,7 | 5,0 | - | 3,7 | 4,0 | 4,5 | - | - | - | - | - | - | 90 |
| 91 | 5,9 | 6,2 | - | 4,3 | 4,6 | - | - | 3,6 | 4,1 | - | - | - | - | - | - | 91 |
| 92 | 5,6 | 5,9 | - | 4,0 | 4,3 | - | - | - | 3,7 | - | - | - | - | - | - | 92 |
| 93 | 5,3 | 5,5 | - | 3,7 | 3,9 | - | - | - | - | - | - | - | - | - | - | 93 |
| 94 | 5,0 | 5,2 | - | - | 3,6 | - | - | - | - | - | - | - | - | - | - | 94 |
| 98 | 3,8 | - | - | - | - | - | - | - | - | - | - | - | - | - | - | 98 |

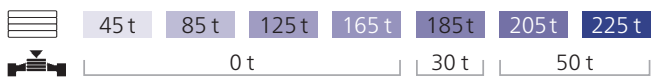

| + | | 36 m | | | 8,40 m | | | 9.8 m/s | | | 360° | | | ISO | | | | | |
|-----|------|---------|------|------|--------|------|------|---------|------|------|------|------|------|------|------|------|------|------|-----|
| | | 48 m | | 54 m | | 60 m | | 66 m | | 72 m | | 78 m | | | | | | | |
| | | LH+LF_1 | | | | | | | | | | | | | | | | | |
| | | 36 m | | | | | | | | | | | | | | | | | |
| | | 15° | | 20° | | 30° | | 15° | | 20° | | 30° | | 15° | | 20° | | 30° | |
| m | t | t | t | t | t | t | t | t | t | t | t | t | t | t | t | t | t | t | m |
| 18 | 53,5 | - | - | - | - | - | - | - | - | - | - | - | - | - | - | - | - | - | 18 |
| 19 | 51,7 | - | - | 52,0 | - | - | 52,5 | - | - | - | - | - | - | - | - | - | - | - | 19 |
| 20 | 50,0 | - | - | 50,5 | - | - | 51,0 | - | - | 51,0 | - | - | 51,5 | - | - | - | - | - | 20 |
| 21 | 48,4 | 39,1 | - | 49,0 | - | - | 49,5 | - | - | 49,8 | - | - | 50,2 | - | - | 50,0 | - | - | 21 |
| 22 | 46,8 | 38,0 | - | 47,6 | 38,3 | - | 48,1 | 38,6 | - | 48,6 | - | - | 48,9 | - | - | 49,1 | - | - | 22 |
| 23 | 45,4 | 37,0 | - | 46,2 | 37,3 | - | 46,8 | 37,6 | - | 47,3 | 37,8 | - | 47,7 | 37,9 | - | 47,9 | - | - | 23 |
| 24 | 44,1 | 36,0 | - | 44,9 | 36,4 | - | 45,5 | 36,7 | - | 46,1 | 36,9 | - | 46,5 | 37,0 | - | 46,8 | 37,1 | - | 24 |
| 26 | 41,7 | 34,2 | - | 42,6 | 34,6 | - | 43,3 | 35,0 | - | 43,8 | 35,3 | - | 44,3 | 35,5 | - | 44,6 | 35,7 | - | 26 |
| 27 | 40,6 | 33,4 | 22,3 | 41,5 | 33,8 | 22,3 | 42,2 | 34,2 | - | 42,8 | 34,5 | - | 43,3 | 34,8 | - | 43,6 | 35,0 | - | 27 |
| 28 | 39,5 | 32,6 | 21,8 | 40,4 | 33,1 | 21,9 | 41,2 | 33,5 | 22,0 | 41,9 | 33,8 | 22,0 | 42,3 | 34,1 | - | 42,7 | 34,3 | - | 28 |
| 29 | 38,4 | 31,8 | 21,3 | 39,4 | 32,3 | 21,5 | 40,2 | 32,8 | 21,6 | 40,9 | 33,1 | 21,6 | 41,4 | 33,4 | 21,6 | 41,8 | 33,6 | 21,6 | 29 |
| 30 | 37,4 | 31,0 | 20,9 | 38,4 | 31,6 | 21,1 | 39,3 | 32,1 | 21,2 | 40,0 | 32,5 | 21,2 | 40,6 | 32,8 | 21,2 | 41,0 | 33,0 | 21,3 | 30 |
| 34 | 33,7 | 28,3 | 19,4 | 34,8 | 29,0 | 19,6 | 35,8 | 29,5 | 19,8 | 36,6 | 30,0 | 19,9 | 37,3 | 30,4 | 20,0 | 37,9 | 30,8 | 20,0 | 34 |
| 38 | 30,7 | 26,0 | 18,0 | 31,7 | 26,7 | 18,3 | 32,7 | 27,3 | 18,5 | 33,6 | 27,9 | 18,7 | 34,4 | 28,3 | 18,8 | 35,1 | 28,7 | 18,9 | 38 |
| 42 | 28,3 | 24,0 | 16,9 | 29,2 | 24,7 | 17,2 | 30,2 | 25,4 | 17,4 | 31,1 | 25,9 | 17,6 | 31,8 | 26,5 | 17,8 | 32,6 | 26,9 | 17,9 | 42 |
| 46 | 26,4 | 22,5 | 15,9 | 27,3 | 23,1 | 16,2 | 28,1 | 23,7 | 16,4 | 28,9 | 24,3 | 16,7 | 29,6 | 24,8 | 16,9 | 30,4 | 25,3 | 17,0 | 46 |
| 50 | 24,6 | 21,1 | 15,0 | 25,6 | 21,8 | 15,3 | 26,4 | 22,4 | 15,6 | 27,1 | 22,9 | 15,8 | 27,8 | 23,4 | 16,0 | 28,5 | 23,9 | 16,2 | 50 |
| 54 | 22,9 | 19,8 | 14,3 | 24,0 | 20,6 | 14,6 | 24,9 | 21,2 | 14,9 | 25,7 | 21,8 | 15,1 | 26,3 | 22,2 | 15,3 | 26,9 | 22,6 | 15,5 | 54 |
| 58 | 21,5 | 18,7 | 13,6 | 22,5 | 19,4 | 13,9 | 23,5 | 20,1 | 14,2 | 24,3 | 20,6 | 14,5 | 25,0 | 21,1 | 14,7 | 25,6 | 21,6 | 14,9 | 58 |
| 62 | 20,2 | 17,7 | 13,1 | 21,3 | 18,4 | 13,4 | 22,2 | 19,1 | 13,6 | 23,0 | 19,6 | 13,9 | 23,7 | 20,2 | 14,1 | 24,2 | 20,6 | 14,3 | 62 |
| 66 | 19,1 | 16,8 | 12,6 | 20,1 | 17,6 | 12,9 | 21,0 | 18,2 | 13,1 | 21,8 | 18,7 | 13,4 | 22,4 | 19,2 | 13,6 | 21,1 | 19,7 | 13,8 | 66 |
| 70 | 18,2 | 16,1 | 12,3 | 19,1 | 16,8 | 12,5 | 20,0 | 17,4 | 12,7 | 20,7 | 17,9 | 12,9 | 21,7 | 18,4 | 13,1 | 20,3 | 18,9 | 13,3 | 70 |
| 74 | 17,4 | 15,5 | - | 18,2 | 16,1 | 12,2 | 19,1 | 16,7 | 12,4 | 18,3 | 17,2 | 12,5 | 17,3 | 17,7 | 12,7 | 15,9 | 16,4 | 12,9 | 74 |
| 75 | 17,2 | 15,3 | - | 18,0 | 15,9 | 12,1 | 18,7 | 16,5 | 12,3 | 17,7 | 17,0 | 12,4 | 16,7 | 17,1 | 12,6 | 15,3 | 15,8 | 12,8 | 75 |
| 76 | 17,0 | 15,2 | - | 17,8 | 15,8 | - | 18,3 | 16,4 | 12,2 | 17,2 | 16,8 | 12,3 | 16,2 | 16,6 | 12,5 | 14,8 | 15,3 | 12,7 | 76 |
| 78 | 16,7 | - | - | 17,5 | 15,5 | - | 17,6 | 16,1 | 12,1 | 16,2 | 16,5 | 12,2 | 15,1 | 15,6 | 12,4 | 13,7 | 14,2 | 12,5 | 78 |
| 79 | - | - | - | 17,3 | 15,4 | - | 17,1 | 15,9 | 12,0 | 15,7 | 16,0 | 12,1 | 14,6 | 15,1 | 12,3 | 13,2 | 13,7 | 12,4 | 79 |
| 81 | - | - | - | 16,9 | 15,2 | - | 16,1 | 15,6 | - | 14,7 | 15,0 | 12,0 | 13,6 | 14,1 | 12,2 | 12,2 | 12,7 | 12,2 | 81 |
| 82 | - | - | - | 16,8 | - | - | 15,7 | 15,5 | - | 14,2 | 14,6 | 12,0 | 13,2 | 13,6 | 12,1 | 11,8 | 12,2 | 12,2 | 82 |
| 83 | - | - | - | 16,6 | - | - | 15,2 | 15,1 | - | 13,7 | 14,1 | 11,9 | 12,7 | 13,1 | 12,0 | 11,3 | 11,7 | 11,9 | 83 |
| 86 | - | - | - | - | - | - | 13,9 | 14,1 | - | 12,5 | 12,8 | - | 11,5 | 11,8 | 11,9 | 10,0 | 10,4 | 11,1 | 86 |
| 87 | - | - | - | - | - | - | 13,5 | - | - | 12,1 | 12,4 | - | 11,1 | 11,4 | 11,8 | 9,6 | 10,0 | 10,6 | 87 |
| 88 | - | - | - | - | - | - | 13,1 | - | - | 11,7 | 12,0 | - | 10,7 | 11,0 | - | 9,2 | 9,6 | 10,2 | 88 |
| 90 | - | - | - | - | - | - | - | - | - | 10,9 | 11,2 | - | 9,9 | 10,2 | - | 8,4 | 8,8 | 9,4 | 90 |
| 92 | - | - | - | - | - | - | - | - | - | 10,2 | - | - | 9,1 | 9,4 | - | 7,7 | 8,0 | 8,6 | 92 |
| 94 | - | - | - | - | - | - | - | - | - | 9,5 | - | - | 8,5 | 8,7 | - | 7,0 | 7,3 | - | 94 |
| 95 | - | - | - | - | - | - | - | - | - | - | - | - | 8,1 | 8,3 | - | 6,6 | 6,9 | - | 95 |
| 98 | - | - | - | - | - | - | - | - | - | - | - | - | 7,1 | - | - | 5,7 | 5,9 | - | 98 |
| 99 | - | - | - | - | - | - | - | - | - | - | - | - | 6,8 | - | - | 5,3 | 5,6 | - | 99 |
| 100 | - | - | - | - | - | - | - | - | - | - | - | - | - | - | - | 5,0 | 5,3 | - | 100 |
| 102 | - | - | - | - | - | - | - | - | - | - | - | - | - | - | - | 4,4 | - | - | 102 |
| 104 | - | - | - | - | - | - | - | - | - | - | - | - | - | - | - | 3,9 | - | - | 104 |

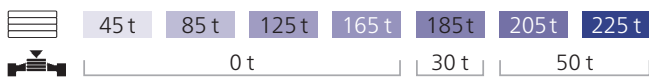

| m | t | t | t | t | t | t | t | t | t | t | t | t | m |
|-----|------|------|------|------|------|------|------|------|------|------|------|------|-----|
| 21 | 50,0 | - | - | - | - | - | - | - | - | - | - | - | 21 |
| 22 | 49,0 | - | - | 48,2 | - | - | - | - | - | - | - | - | 22 |
| 23 | 47,9 | - | - | 47,4 | - | - | 43,9 | - | - | 41,1 | - | - | 23 |
| 24 | 46,9 | 37,0 | - | 46,6 | - | - | 43,4 | - | - | 40,6 | - | - | 24 |
| 25 | 45,9 | 36,3 | - | 45,8 | 36,3 | - | 42,8 | 36,0 | - | 40,0 | - | - | 25 |
| 26 | 44,9 | 35,7 | - | 45,0 | 35,7 | - | 42,3 | 35,4 | - | 39,5 | 33,9 | - | 26 |
| 28 | 43,1 | 34,4 | - | 43,3 | 34,4 | - | 41,2 | 34,3 | - | 38,4 | 33,1 | - | 28 |
| 30 | 41,4 | 33,2 | 21,2 | 41,7 | 33,3 | 21,1 | 40,1 | 33,2 | - | 37,4 | 32,3 | - | 30 |
| 31 | 40,6 | 32,6 | 20,9 | 40,9 | 32,7 | 20,8 | 39,5 | 32,7 | 20,7 | 36,8 | 31,9 | 20,6 | 31 |
| 34 | 38,5 | 31,0 | 20,0 | 38,8 | 31,2 | 20,0 | 37,9 | 31,2 | 20,0 | 35,2 | 30,7 | 19,9 | 34 |
| 38 | 35,8 | 29,1 | 19,0 | 36,2 | 29,4 | 19,0 | 35,8 | 29,4 | 19,0 | 33,2 | 29,2 | 19,0 | 38 |
| 42 | 33,4 | 27,4 | 18,1 | 33,9 | 27,7 | 18,1 | 33,8 | 27,8 | 18,1 | 31,2 | 27,7 | 18,1 | 42 |
| 46 | 31,2 | 25,8 | 17,2 | 31,8 | 26,1 | 17,3 | 31,9 | 26,3 | 17,3 | 29,4 | 26,3 | 17,4 | 46 |
| 50 | 29,3 | 24,4 | 16,4 | 29,9 | 24,7 | 16,5 | 30,2 | 25,0 | 16,6 | 27,7 | 24,9 | 16,6 | 50 |
| 54 | 27,7 | 23,1 | 15,7 | 28,2 | 23,5 | 15,8 | 28,6 | 23,8 | 15,9 | 26,1 | 23,7 | 16,0 | 54 |
| 58 | 26,3 | 22,1 | 15,1 | 26,0 | 22,4 | 15,2 | 25,1 | 22,7 | 15,3 | 23,6 | 22,5 | 15,4 | 58 |
| 62 | 23,7 | 21,2 | 14,5 | 22,3 | 21,5 | 14,7 | 21,4 | 21,7 | 14,8 | 20,1 | 21,1 | 14,8 | 62 |
| 66 | 20,5 | 20,3 | 14,0 | 19,1 | 20,0 | 14,2 | 18,2 | 19,1 | 14,3 | 16,9 | 17,8 | 14,3 | 66 |
| 70 | 17,8 | 18,4 | 13,5 | 16,4 | 17,1 | 13,7 | 15,4 | 16,2 | 13,8 | 14,1 | 14,9 | 14,0 | 70 |
| 74 | 15,3 | 15,9 | 13,1 | 13,9 | 14,6 | 13,3 | 13,0 | 13,7 | 13,4 | 11,6 | 12,4 | 13,6 | 74 |
| 78 | 13,1 | 13,7 | 12,8 | 11,7 | 12,3 | 12,9 | 10,8 | 11,4 | 12,7 | 9,4 | 10,1 | 11,4 | 78 |
| 82 | 11,2 | 11,7 | 12,4 | 9,8 | 10,3 | 11,3 | 8,8 | 9,4 | 10,5 | 7,4 | 8,0 | 9,3 | 82 |
| 86 | 9,4 | 9,9 | 10,7 | 8,0 | 8,5 | 9,4 | 7,0 | 7,6 | 8,6 | 5,6 | 6,2 | 7,3 | 86 |
| 90 | 7,8 | 8,2 | 8,9 | 6,4 | 6,8 | 7,6 | 5,4 | 5,9 | 6,8 | 4,0 | 4,5 | 5,5 | 90 |
| 91 | 7,4 | 7,8 | 8,5 | 6,0 | 6,5 | 7,2 | 5,0 | 5,5 | 6,4 | 3,6 | 4,1 | 5,1 | 91 |
| 92 | 7,1 | 7,5 | 8,1 | 5,6 | 6,1 | 6,8 | 4,7 | 5,1 | 6,0 | - | 3,7 | 4,7 | 92 |
| 94 | 6,4 | 6,8 | 7,3 | 4,9 | 5,3 | 6,0 | 4,0 | 4,4 | 5,2 | - | - | 3,9 | 94 |
| 95 | 6,0 | 6,4 | 6,9 | 4,5 | 4,9 | 5,6 | 3,6 | 4,0 | 4,8 | - | - | 3,5 | 95 |
| 96 | 5,7 | 6,0 | 6,6 | 4,2 | 4,6 | 5,3 | - | 3,7 | 4,4 | - | - | - | 96 |
| 98 | 5,1 | 5,4 | - | 3,6 | 4,0 | 4,6 | - | - | 3,7 | - | - | - | 98 |
| 99 | 4,8 | 5,0 | - | - | 3,6 | 4,2 | - | - | - | - | - | - | 99 |
| 100 | 4,5 | 4,7 | - | - | - | 3,9 | - | - | - | - | - | - | 100 |
| 102 | 3,9 | 4,1 | - | - | - | - | - | - | - | - | - | - | 102 |
| 103 | 3,6 | 3,8 | - | - | - | - | - | - | - | - | - | - | 103 |
| 104 | - | 3,5 | - | - | - | - | - | - | - | - | - | - | 104 |

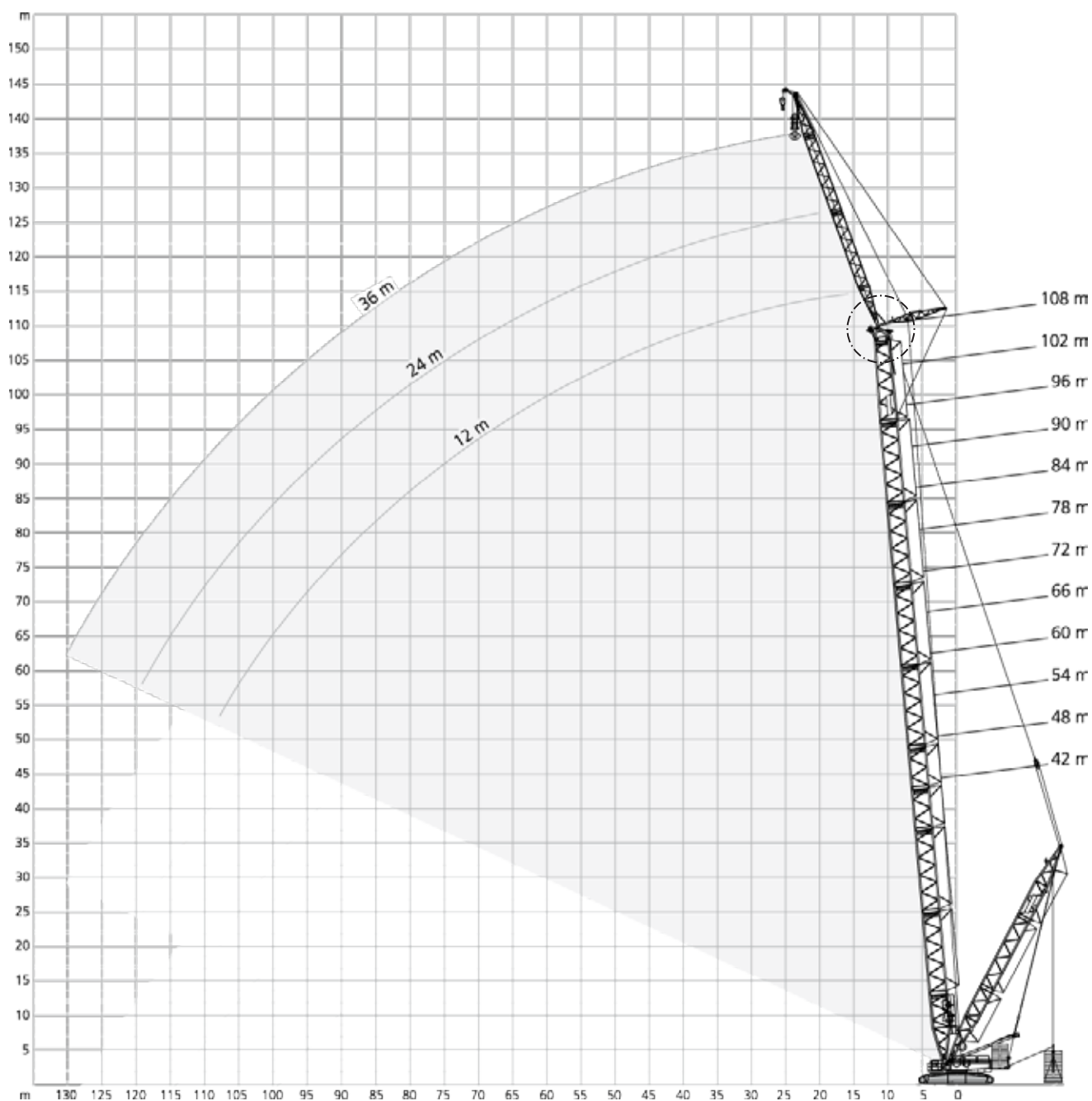
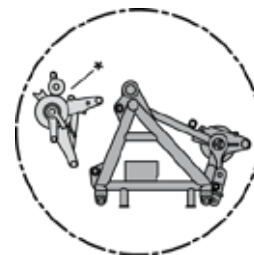

* Attachable · Anbaubar · Amovible · Montabile · Acoplable · Adaptável · Приставн

| 165 t + 50 t | | 8,40 m | | 9.8 m/s | | 360° | | ISO | | | | | | | | | | | | | | | |
|--------------|-------|--------|-------|---------|------|-------|------|------|------|-------|------|------|------|-------|------|------|------|-------|---|-----|---|-------|--|
| 42 m | | | | | | | | | | | | | | | | | | | | | | | |
| SSL+LF_1 | | | | | | | | | | | | | | | | | | | | | | | |
| 12 m | | | | | | 24 m | | | | | | 36 m | | | | | | | | | | | |
| 0 t | | 325 t | | 0 t | | 325 t | | 0 t | | 325 t | | 0 t | | 325 t | | 0 t | | 325 t | | 0 t | | 325 t | |
| 15° | | 20° | | 30° | | 15° | | 20° | | 30° | | 15° | | 20° | | 30° | | | | | | | |
| m | t | t | t | t | t | t | t | t | t | t | t | t | t | t | t | t | t | t | t | t | t | | |
| 11 | 162,0 | 162,0 | - | - | - | - | - | - | - | - | - | - | - | - | - | - | - | - | - | - | - | | |
| 12 | 154,0 | 154,0 | 120,0 | 120,0 | - | - | - | - | - | - | - | - | - | - | - | - | - | - | - | - | - | | |
| 13 | 147,0 | 147,0 | 115,5 | 115,5 | 76,5 | 76,5 | - | - | - | - | - | - | - | - | - | - | - | - | - | - | - | | |
| 14 | 140,0 | 140,0 | 111,0 | 111,0 | 74,5 | 74,5 | - | - | - | - | - | - | - | - | - | - | - | - | - | - | - | | |
| 15 | 134,0 | 134,0 | 107,0 | 107,0 | 72,5 | 72,5 | 79,0 | 79,0 | - | - | - | - | - | - | - | - | - | - | - | - | - | | |
| 16 | 128,0 | 128,0 | 103,0 | 103,0 | 70,5 | 70,5 | 75,5 | 75,5 | - | - | - | - | - | - | - | - | - | - | - | - | - | | |
| 17 | 123,5 | 123,5 | 99,7 | 99,7 | 68,7 | 68,7 | 72,5 | 72,5 | 58,0 | 58,0 | - | - | - | - | - | - | - | - | - | - | - | | |
| 18 | 119,0 | 119,0 | 96,5 | 96,5 | 67,0 | 67,0 | 69,5 | 69,5 | 56,0 | 56,0 | - | - | - | - | - | - | - | - | - | - | - | | |
| 19 | 114,5 | 114,5 | 93,7 | 93,7 | 65,5 | 65,5 | 67,0 | 67,0 | 54,2 | 54,2 | - | - | 50,0 | 50,5 | - | - | - | - | - | - | - | | |
| 20 | 110,0 | 110,0 | 91,0 | 91,0 | 64,0 | 64,0 | 64,5 | 64,5 | 52,5 | 52,5 | 35,9 | 35,9 | 48,4 | 48,6 | - | - | - | - | - | - | - | | |
| 22 | 103,0 | 103,0 | 86,0 | 86,0 | 61,5 | 61,5 | 60,0 | 60,0 | 49,3 | 49,3 | 34,1 | 34,1 | 45,1 | 45,2 | 37,0 | 37,0 | - | - | - | - | - | | |
| 24 | 97,0 | 97,0 | 81,5 | 81,5 | 59,0 | 59,0 | 56,0 | 56,0 | 46,5 | 46,5 | 32,5 | 32,5 | 42,2 | 42,4 | 34,7 | 34,7 | - | - | - | - | - | | |
| 26 | 91,5 | 91,5 | 77,5 | 77,5 | 56,5 | 56,5 | 53,0 | 53,0 | 44,0 | 44,0 | 31,1 | 31,1 | 39,6 | 39,8 | 32,7 | 32,7 | - | - | - | - | - | | |
| 27 | 89,0 | 89,0 | 75,5 | 75,5 | 55,5 | 55,5 | 51,4 | 51,4 | 42,9 | 42,9 | 30,4 | 30,4 | 38,4 | 38,6 | 31,8 | 31,8 | 21,8 | 21,8 | - | - | - | | |
| 28 | 86,5 | 86,5 | 73,5 | 73,5 | 54,5 | 54,5 | 49,9 | 49,9 | 41,8 | 41,8 | 29,8 | 29,8 | 37,3 | 37,4 | 30,9 | 30,9 | 21,3 | 21,3 | - | - | - | | |
| 30 | 78,5 | 82,5 | 70,5 | 70,5 | 53,0 | 53,0 | 47,2 | 47,2 | 39,8 | 39,8 | 28,6 | 28,6 | 35,1 | 35,2 | 29,3 | 29,3 | 20,3 | 20,3 | - | - | - | | |
| 34 | 66,5 | 75,1 | 63,8 | 65,1 | 50,0 | 50,0 | 42,8 | 42,8 | 36,4 | 36,4 | 26,6 | 26,6 | 31,5 | 31,6 | 26,5 | 26,5 | 18,7 | 18,7 | - | - | - | | |
| 38 | 56,4 | 69,0 | 56,5 | 60,6 | 47,6 | 47,6 | 38,9 | 38,9 | 33,5 | 33,5 | 24,9 | 24,9 | 28,5 | 28,5 | 24,1 | 24,1 | 17,2 | 17,2 | - | - | - | | |
| 42 | 48,3 | 64,0 | 48,5 | 57,0 | 45,6 | 45,6 | 35,7 | 35,7 | 31,0 | 31,0 | 23,4 | 23,4 | 26,0 | 26,0 | 22,1 | 22,1 | 16,0 | 16,0 | - | - | - | | |
| 44 | 45,3 | 62,1 | 45,5 | 55,6 | 42,9 | 44,8 | 34,4 | 34,4 | 30,0 | 30,0 | 22,8 | 22,8 | 24,9 | 24,9 | 21,3 | 21,3 | 15,4 | 15,4 | - | - | - | | |
| 46 | 42,4 | 60,3 | 42,5 | 54,3 | - | - | 33,1 | 33,1 | 29,0 | 29,0 | 22,2 | 22,2 | 23,9 | 23,9 | 20,5 | 20,5 | 14,9 | 14,9 | - | - | - | | |
| 48 | 39,5 | 58,5 | 39,6 | 53,0 | - | - | 31,9 | 31,9 | 28,1 | 28,1 | 21,7 | 21,7 | 22,9 | 22,9 | 19,7 | 19,7 | 14,4 | 14,4 | - | - | - | | |
| 50 | 37,1 | 57,0 | - | - | - | - | 30,9 | 30,9 | 27,3 | 27,3 | 21,2 | 21,2 | 22,1 | 22,1 | 19,0 | 19,0 | 14,0 | 14,0 | - | - | - | | |
| 54 | - | - | - | - | - | - | 29,0 | 29,0 | 25,8 | 25,8 | 20,4 | 20,4 | 20,5 | 20,5 | 17,8 | 17,8 | 13,2 | 13,2 | - | - | - | | |
| 55 | - | - | - | - | - | - | 28,6 | 28,6 | 25,5 | 25,5 | 20,3 | 20,3 | 20,1 | 20,1 | 17,5 | 17,5 | 13,0 | 13,0 | - | - | - | | |
| 58 | - | - | - | - | - | - | 27,5 | 27,5 | 24,7 | 24,7 | - | - | 19,1 | 19,1 | 16,7 | 16,7 | 12,6 | 12,6 | - | - | - | | |
| 60 | - | - | - | - | - | - | 26,8 | 26,8 | 24,2 | 24,2 | - | - | 18,5 | 18,5 | 16,2 | 16,2 | 12,3 | 12,3 | - | - | - | | |
| 62 | - | - | - | - | - | - | 26,3 | 26,3 | - | - | - | - | 18,0 | 18,0 | 15,8 | 15,8 | 12,0 | 12,0 | - | - | - | | |
| 66 | - | - | - | - | - | - | - | - | - | - | - | - | 17,0 | 17,0 | 15,0 | 15,0 | 11,6 | 11,6 | - | - | - | | |
| 67 | - | - | - | - | - | - | - | - | - | - | - | - | 16,8 | 16,8 | 14,8 | 14,8 | 11,5 | 11,5 | - | - | - | | |
| 70 | - | - | - | - | - | - | - | - | - | - | - | - | 16,2 | 16,2 | 14,4 | 14,4 | - | - | - | - | - | | |
| 72 | - | - | - | - | - | - | - | - | - | - | - | - | 15,8 | 15,8 | 14,1 | 14,1 | - | - | - | - | - | | |
| 73 | - | - | - | - | - | - | - | - | - | - | - | - | 15,6 | 15,6 | - | - | - | - | - | - | - | | |



| | | 165 t + 50 t | | | | 8,40 m | | | | 9.8 m/s | | | | 360° | | | | ISO | | | |
|----|-------|--------------|-------|---------|------|---------|------|---------|------|---------|------|---------|------|---------|------|---------|------|---------|---|--|--|
| | | 48 m | | | | | | | | | | | | | | | | | | | |
| | | SSL+LF_1 | | | | | | | | | | | | | | | | | | | |
| | | 12 m | | | | 24 m | | | | 36 m | | | | | | | | | | | |
| | | 0t-325t | | 0t-325t | | 0t-325t | | 0t-325t | | 0t-325t | | 0t-325t | | 0t-325t | | 0t-325t | | 0t-325t | | | |
| | | 15° | | 20° | | 30° | | 15° | | 20° | | 30° | | 15° | | 20° | | 30° | | | |
| m | t | t | t | t | t | t | t | t | t | t | t | t | t | t | t | t | t | t | t | | |
| 11 | 167,0 | 167,0 | - | - | - | - | - | - | - | - | - | - | - | - | - | - | - | - | - | | |
| 12 | 159,0 | 159,0 | 122,0 | 122,0 | - | - | - | - | - | - | - | - | - | - | - | - | - | - | - | | |
| 14 | 145,0 | 145,0 | 114,0 | 114,0 | 75,5 | 75,5 | - | - | - | - | - | - | - | - | - | - | - | - | - | | |
| 15 | 139,5 | 139,5 | 110,0 | 110,0 | 73,7 | 73,7 | 81,0 | 81,0 | - | - | - | - | - | - | - | - | - | - | - | | |
| 16 | 134,0 | 134,0 | 106,0 | 106,0 | 72,0 | 72,0 | 78,0 | 78,0 | - | - | - | - | - | - | - | - | - | - | - | | |
| 17 | 129,0 | 129,0 | 103,0 | 103,0 | 70,2 | 70,2 | 75,0 | 75,0 | 59,0 | 59,0 | - | - | - | - | - | - | - | - | - | | |
| 18 | 124,0 | 124,0 | 100,0 | 100,0 | 68,5 | 68,5 | 72,0 | 72,0 | 57,0 | 57,0 | - | - | - | - | - | - | - | - | - | | |
| 19 | 120,0 | 120,0 | 97,2 | 97,2 | 67,0 | 67,0 | 69,5 | 69,5 | 55,2 | 55,2 | - | - | 51,0 | 51,0 | - | - | - | - | - | | |
| 20 | 116,0 | 116,0 | 94,5 | 94,5 | 65,5 | 65,5 | 67,0 | 67,0 | 53,5 | 53,5 | - | - | 49,2 | 49,4 | - | - | - | - | - | | |
| 21 | 112,5 | 112,5 | 92,0 | 92,0 | 64,2 | 64,2 | 64,7 | 64,7 | 52,0 | 52,0 | 35,4 | 35,4 | 47,5 | 47,7 | - | - | - | - | - | | |
| 22 | 109,0 | 109,0 | 89,5 | 89,5 | 63,0 | 63,0 | 62,5 | 62,5 | 50,5 | 50,5 | 34,6 | 34,6 | 45,9 | 46,1 | 37,3 | 37,5 | - | - | - | | |
| 24 | 102,0 | 102,0 | 85,0 | 85,0 | 60,5 | 60,5 | 58,5 | 58,5 | 48,0 | 48,0 | 33,1 | 33,1 | 43,1 | 43,3 | 35,2 | 35,4 | - | - | - | | |
| 26 | 95,0 | 97,0 | 81,0 | 81,0 | 58,5 | 58,5 | 55,0 | 55,0 | 45,5 | 45,5 | 31,7 | 31,7 | 40,7 | 40,8 | 33,4 | 33,4 | - | - | - | | |
| 28 | 85,5 | 92,0 | 77,5 | 77,5 | 56,5 | 56,5 | 52,0 | 52,0 | 43,3 | 43,3 | 30,5 | 30,5 | 38,4 | 38,5 | 31,7 | 31,7 | 21,5 | 21,5 | - | | |
| 30 | 77,0 | 87,5 | 74,0 | 74,0 | 54,5 | 54,5 | 49,6 | 49,6 | 41,3 | 41,3 | 29,3 | 29,3 | 36,3 | 36,4 | 30,1 | 30,1 | 20,6 | 20,6 | - | | |
| 34 | 65,0 | 80,1 | 64,3 | 68,6 | 51,5 | 51,5 | 45,1 | 45,1 | 37,9 | 37,9 | 27,3 | 27,3 | 32,7 | 32,8 | 27,4 | 27,4 | 19,0 | 19,0 | - | | |
| 38 | 54,9 | 73,8 | 55,4 | 64,0 | 49,0 | 49,0 | 41,2 | 41,2 | 35,0 | 35,0 | 25,6 | 25,6 | 29,7 | 29,7 | 25,0 | 25,0 | 17,6 | 17,6 | - | | |
| 42 | 46,9 | 68,5 | 47,2 | 60,0 | 47,0 | 47,0 | 37,8 | 37,8 | 32,5 | 32,5 | 24,1 | 24,1 | 27,1 | 27,2 | 23,0 | 23,0 | 16,4 | 16,4 | - | | |
| 46 | 40,9 | 64,1 | 41,2 | 57,0 | 41,3 | 45,4 | 35,1 | 35,1 | 30,4 | 30,4 | 22,9 | 22,9 | 25,1 | 25,1 | 21,4 | 21,4 | 15,4 | 15,4 | - | | |
| 48 | 38,0 | 62,0 | 38,2 | 55,5 | 38,5 | 44,7 | 33,8 | 33,8 | 29,4 | 29,4 | 22,4 | 22,4 | 24,1 | 24,1 | 20,6 | 20,6 | 14,9 | 14,9 | - | | |
| 50 | 35,7 | 60,5 | 35,8 | 54,3 | - | - | 32,7 | 32,7 | 28,6 | 28,6 | 21,9 | 21,9 | 23,2 | 23,2 | 19,9 | 19,9 | 14,4 | 14,4 | - | | |
| 53 | 32,4 | 58,2 | 32,4 | 52,5 | - | - | 31,2 | 31,2 | 27,4 | 27,4 | 21,2 | 21,2 | 22,0 | 22,0 | 18,9 | 18,9 | 13,8 | 13,8 | - | | |
| 54 | 31,3 | 57,5 | - | - | - | - | 30,7 | 30,7 | 27,1 | 27,1 | 21,0 | 21,0 | 21,6 | 21,6 | 18,6 | 18,6 | 13,6 | 13,6 | - | | |
| 55 | 30,4 | 57,0 | - | - | - | - | 30,2 | 30,3 | 26,8 | 26,8 | 20,8 | 20,8 | 21,2 | 21,2 | 18,3 | 18,3 | 13,4 | 13,4 | - | | |
| 58 | - | - | - | - | - | - | 28,9 | 29,1 | 25,9 | 25,9 | 20,3 | 20,3 | 20,2 | 20,2 | 17,5 | 17,5 | 13,0 | 13,0 | - | | |
| 59 | - | - | - | - | - | - | 28,5 | 28,7 | 25,6 | 25,6 | 20,2 | 20,2 | 19,9 | 19,9 | 17,2 | 17,2 | 12,8 | 12,8 | - | | |
| 62 | - | - | - | - | - | - | 26,6 | 27,7 | 24,8 | 24,8 | - | - | 19,0 | 19,0 | 16,5 | 16,5 | 12,4 | 12,4 | - | | |
| 65 | - | - | - | - | - | - | 24,4 | 26,8 | 24,1 | 24,1 | - | - | 18,1 | 18,1 | 15,9 | 15,9 | 12,0 | 12,0 | - | | |
| 66 | - | - | - | - | - | - | 23,7 | 26,5 | - | - | - | - | 17,9 | 17,9 | 15,7 | 15,7 | 11,9 | 11,9 | - | | |
| 67 | - | - | - | - | - | - | 23,0 | 26,3 | - | - | - | - | 17,6 | 17,6 | 15,5 | 15,5 | 11,8 | 11,8 | - | | |
| 70 | - | - | - | - | - | - | - | - | - | - | - | - | 17,0 | 17,0 | 15,0 | 15,0 | 11,5 | 11,5 | - | | |
| 71 | - | - | - | - | - | - | - | - | - | - | - | - | 16,8 | 16,8 | 14,8 | 14,8 | 11,4 | 11,4 | - | | |
| 74 | - | - | - | - | - | - | - | - | - | - | - | - | 16,2 | 16,2 | 14,4 | 14,4 | - | - | - | | |
| 76 | - | - | - | - | - | - | - | - | - | - | - | - | 15,9 | 15,9 | 14,2 | 14,2 | - | - | - | | |
| 78 | - | - | - | - | - | - | - | - | - | - | - | - | 15,6 | 15,6 | - | - | - | - | - | | |

| | | | | | | | |
|--|----|-----|------|------|------|------|------|
| | 0t | 65t | 125t | 165t | 205t | 265t | 325t |
|--|----|-----|------|------|------|------|------|

| 165 t + 50 t | | 8,40 m | | 9.8 m/s | | 360° | | ISO | | | | | | | | | | | |
|--------------|-------|--------|-------|---------|------|-------|------|------|------|-------|------|------|------|-------|------|------|------|-------|---|
| 54 m | | | | | | | | | | | | | | | | | | | |
| SSL+LF_1 | | | | | | | | | | | | | | | | | | | |
| 12 m | | | | | | 24 m | | | | | | 36 m | | | | | | | |
| 0 t | | 325 t | | 0 t | | 325 t | | 0 t | | 325 t | | 0 t | | 325 t | | 0 t | | 325 t | |
| 15° | | 20° | | 30° | | 15° | | 20° | | 30° | | 15° | | 20° | | 30° | | | |
| m | t | t | t | t | t | t | t | t | t | t | t | t | t | t | t | t | t | t | t |
| 12 | 163,0 | 163,0 | - | - | - | - | - | - | - | - | - | - | - | - | - | - | - | - | - |
| 13 | 156,5 | 156,5 | 120,0 | 120,0 | - | - | - | - | - | - | - | - | - | - | - | - | - | - | - |
| 14 | 150,0 | 150,0 | 117,0 | 117,0 | 76,5 | 76,5 | - | - | - | - | - | - | - | - | - | - | - | - | - |
| 16 | 139,0 | 139,0 | 109,0 | 109,0 | 73,0 | 73,0 | 79,5 | 79,5 | - | - | - | - | - | - | - | - | - | - | - |
| 18 | 130,0 | 130,0 | 103,0 | 103,0 | 70,0 | 70,0 | 74,0 | 74,0 | 58,0 | 58,0 | - | - | - | - | - | - | - | - | - |
| 20 | 121,0 | 121,0 | 98,0 | 98,0 | 67,0 | 67,0 | 69,0 | 69,0 | 54,5 | 54,5 | - | - | 49,7 | 50,0 | - | - | - | - | - |
| 21 | 117,5 | 117,5 | 95,5 | 95,5 | 65,7 | 65,7 | 66,7 | 66,7 | 53,0 | 53,0 | 35,7 | 35,7 | 48,1 | 48,4 | - | - | - | - | - |
| 22 | 114,0 | 114,0 | 93,0 | 93,0 | 64,5 | 64,5 | 64,5 | 64,5 | 51,5 | 51,5 | 34,9 | 34,9 | 46,6 | 46,8 | - | - | - | - | - |
| 23 | 109,5 | 111,0 | 90,7 | 90,7 | 63,2 | 63,2 | 62,5 | 62,5 | 50,4 | 50,4 | 34,2 | 34,2 | 45,2 | 45,4 | 36,6 | 36,7 | - | - | - |
| 24 | 105,0 | 108,0 | 88,5 | 88,5 | 62,0 | 62,0 | 60,5 | 60,5 | 49,3 | 49,3 | 33,5 | 33,5 | 43,9 | 44,1 | 35,6 | 35,7 | - | - | - |
| 26 | 94,0 | 102,0 | 84,5 | 84,5 | 60,0 | 60,0 | 57,5 | 57,5 | 46,9 | 46,9 | 32,2 | 32,2 | 41,5 | 41,7 | 33,8 | 33,9 | - | - | - |
| 28 | 84,0 | 97,0 | 81,0 | 81,0 | 58,0 | 58,0 | 54,5 | 54,5 | 44,7 | 44,7 | 31,0 | 31,0 | 39,3 | 39,5 | 32,2 | 32,3 | 21,6 | 21,7 | - |
| 30 | 76,0 | 92,5 | 76,5 | 77,5 | 56,5 | 56,5 | 51,5 | 51,5 | 42,7 | 42,7 | 29,9 | 29,9 | 37,3 | 37,5 | 30,8 | 30,8 | 20,8 | 20,8 | - |
| 34 | 64,0 | 84,8 | 64,5 | 72,1 | 53,5 | 53,5 | 47,1 | 47,1 | 39,3 | 39,3 | 28,0 | 28,0 | 33,8 | 33,9 | 28,2 | 28,2 | 19,2 | 19,2 | - |
| 38 | 53,9 | 78,1 | 54,3 | 67,3 | 50,1 | 50,8 | 43,1 | 43,1 | 36,4 | 36,4 | 26,3 | 26,3 | 30,7 | 30,8 | 25,8 | 25,8 | 17,9 | 17,9 | - |
| 42 | 45,7 | 72,5 | 46,0 | 63,0 | 46,5 | 48,5 | 39,7 | 39,7 | 33,8 | 33,8 | 24,8 | 24,8 | 28,1 | 28,2 | 23,8 | 23,8 | 16,7 | 16,7 | - |
| 46 | 39,7 | 68,1 | 40,0 | 59,6 | 40,3 | 46,7 | 37,0 | 37,0 | 31,8 | 31,8 | 23,6 | 23,6 | 26,2 | 26,2 | 22,2 | 22,2 | 15,7 | 15,7 | - |
| 50 | 34,4 | 64,3 | 34,7 | 56,8 | 34,9 | 45,3 | 34,6 | 34,6 | 29,9 | 29,9 | 22,5 | 22,5 | 24,4 | 24,4 | 20,7 | 20,7 | 14,8 | 14,8 | - |
| 52 | 32,2 | 62,6 | 32,4 | 55,6 | 32,5 | 44,7 | 33,5 | 33,5 | 29,1 | 29,1 | 22,0 | 22,0 | 23,5 | 23,5 | 20,0 | 20,0 | 14,4 | 14,4 | - |
| 54 | 30,0 | 61,0 | 30,2 | 54,5 | - | - | 32,4 | 32,4 | 28,3 | 28,3 | 21,6 | 21,6 | 22,7 | 22,7 | 19,4 | 19,4 | 14,0 | 14,0 | - |
| 58 | 26,2 | 58,3 | 26,3 | 52,5 | - | - | 28,8 | 30,6 | 26,9 | 26,9 | 20,8 | 20,8 | 21,3 | 21,3 | 18,2 | 18,2 | 13,3 | 13,3 | - |
| 60 | 24,4 | 57,0 | - | - | - | - | 27,0 | 29,8 | 26,3 | 26,3 | 20,5 | 20,5 | 20,6 | 20,6 | 17,7 | 17,7 | 13,0 | 13,0 | - |
| 62 | - | - | - | - | - | - | 25,4 | 29,1 | 25,0 | 25,8 | 20,2 | 20,2 | 20,0 | 20,0 | 17,2 | 17,2 | 12,7 | 12,7 | - |
| 64 | - | - | - | - | - | - | 23,8 | 28,4 | 23,8 | 25,3 | 20,0 | 20,0 | 19,4 | 19,4 | 16,8 | 16,8 | 12,4 | 12,4 | - |
| 66 | - | - | - | - | - | - | 22,3 | 27,8 | 22,6 | 24,8 | - | - | 18,9 | 18,9 | 16,4 | 16,4 | 12,2 | 12,2 | - |
| 70 | - | - | - | - | - | - | 19,7 | 26,7 | 19,9 | 24,1 | - | - | 17,9 | 17,9 | 15,6 | 15,6 | 11,8 | 11,8 | - |
| 72 | - | - | - | - | - | - | 18,5 | 26,2 | - | - | - | - | 17,4 | 17,4 | 15,3 | 15,3 | 11,6 | 11,6 | - |
| 74 | - | - | - | - | - | - | - | - | - | - | - | - | 17,0 | 17,0 | 15,0 | 15,0 | 11,4 | 11,4 | - |
| 75 | - | - | - | - | - | - | - | - | - | - | - | - | 16,8 | 16,8 | 14,8 | 14,8 | 11,4 | 11,4 | - |
| 78 | - | - | - | - | - | - | - | - | - | - | - | - | 16,3 | 16,3 | 14,4 | 14,4 | - | - | - |
| 81 | - | - | - | - | - | - | - | - | - | - | - | - | 15,1 | 15,8 | 14,1 | 14,1 | - | - | - |
| 82 | - | - | - | - | - | - | - | - | - | - | - | - | 14,7 | 15,7 | - | - | - | - | - |
| 84 | - | - | - | - | - | - | - | - | - | - | - | - | 14,0 | 15,4 | - | - | - | - | - |



| 165 t + 50 t | | 8,40 m | | 9.8 m/s | | 360° | | ISO | | | | | | | | | |
|--------------|-------|-------------|-------|-------------|------|-------------|------|-------------|------|-------------|------|-------------|------|-------------|------|-------------|------|
| 60 m | | | | | | | | | | | | | | | | | |
| SSL+LF_1 | | | | | | | | | | | | | | | | | |
| 12 m | | | | | | 24 m | | | | | | 36 m | | | | | |
| 0 t - 325 t | | 0 t - 325 t | | 0 t - 325 t | | 0 t - 325 t | | 0 t - 325 t | | 0 t - 325 t | | 0 t - 325 t | | 0 t - 325 t | | 0 t - 325 t | |
| 15° | | 20° | | 30° | | 15° | | 20° | | 30° | | 15° | | 20° | | 30° | |
| m | t | t | t | t | t | t | t | t | t | t | t | t | t | t | t | t | t |
| 12 | 167,0 | 167,0 | - | - | - | - | - | - | - | - | - | - | - | - | - | - | - |
| 13 | 161,0 | 161,0 | 123,0 | 123,0 | - | - | - | - | - | - | - | - | - | - | - | - | - |
| 14 | 155,0 | 155,0 | 119,0 | 119,0 | - | - | - | - | - | - | - | - | - | - | - | - | - |
| 15 | 149,5 | 149,5 | 115,5 | 115,5 | 75,5 | 75,5 | - | - | - | - | - | - | - | - | - | - | - |
| 16 | 144,0 | 144,0 | 112,0 | 112,0 | 73,5 | 73,5 | 81,0 | 81,0 | - | - | - | - | - | - | - | - | - |
| 18 | 134,0 | 134,0 | 106,0 | 106,0 | 71,0 | 71,0 | 75,5 | 75,5 | 59,0 | 59,0 | - | - | - | - | - | - | - |
| 20 | 126,0 | 126,0 | 100,0 | 100,0 | 68,0 | 68,0 | 70,5 | 70,5 | 55,5 | 55,5 | - | - | 50,0 | 50,5 | - | - | - |
| 22 | 113,0 | 119,0 | 96,0 | 96,0 | 65,5 | 65,5 | 66,5 | 66,5 | 53,0 | 53,0 | 35,2 | 35,2 | 47,2 | 47,5 | - | - | - |
| 23 | 107,5 | 115,5 | 93,7 | 93,7 | 64,5 | 64,5 | 64,5 | 64,5 | 51,5 | 51,5 | 34,5 | 34,5 | 45,9 | 46,1 | 36,9 | 37,0 | - |
| 24 | 102,0 | 112,0 | 91,5 | 91,5 | 63,5 | 63,5 | 62,5 | 62,5 | 50,0 | 50,0 | 33,8 | 33,8 | 44,6 | 44,8 | 35,9 | 36,1 | - |
| 26 | 92,5 | 107,0 | 87,5 | 87,5 | 61,5 | 61,5 | 59,5 | 59,5 | 48,0 | 48,0 | 32,6 | 32,6 | 42,2 | 42,5 | 34,2 | 34,3 | - |
| 28 | 83,0 | 101,0 | 83,5 | 84,0 | 59,5 | 59,5 | 56,5 | 56,5 | 45,9 | 45,9 | 31,5 | 31,5 | 40,2 | 40,4 | 32,7 | 32,8 | - |
| 29 | 78,7 | 99,0 | 79,5 | 82,2 | 58,5 | 58,5 | 55,0 | 55,0 | 44,9 | 44,9 | 30,9 | 30,9 | 39,2 | 39,4 | 32,0 | 32,1 | 21,3 |
| 30 | 74,5 | 97,0 | 75,5 | 80,5 | 57,5 | 57,5 | 53,5 | 53,5 | 44,0 | 44,0 | 30,4 | 30,4 | 38,2 | 38,4 | 31,3 | 31,4 | 20,9 |
| 34 | 62,5 | 89,3 | 63,1 | 75,1 | 54,5 | 54,5 | 49,1 | 49,1 | 40,6 | 40,6 | 28,5 | 28,5 | 34,8 | 34,9 | 28,7 | 28,8 | 19,5 |
| 38 | 52,4 | 82,5 | 52,8 | 70,3 | 50,3 | 51,9 | 45,1 | 45,1 | 37,7 | 37,7 | 26,8 | 26,8 | 31,7 | 31,8 | 26,5 | 26,6 | 18,2 |
| 42 | 44,2 | 76,5 | 44,5 | 66,0 | 45,1 | 49,9 | 41,6 | 41,6 | 35,1 | 35,1 | 25,4 | 25,4 | 29,0 | 29,1 | 24,5 | 24,6 | 17,0 |
| 46 | 38,2 | 71,8 | 38,5 | 62,3 | 38,9 | 48,0 | 38,8 | 38,8 | 33,0 | 33,0 | 24,2 | 24,2 | 27,0 | 27,1 | 22,9 | 22,9 | 16,0 |
| 50 | 32,8 | 67,6 | 33,1 | 59,1 | 33,5 | 46,4 | 35,2 | 36,2 | 31,1 | 31,1 | 23,1 | 23,1 | 25,3 | 25,3 | 21,4 | 21,4 | 15,2 |
| 54 | 28,1 | 64,0 | 28,3 | 56,5 | 28,7 | 45,1 | 31,0 | 34,0 | 29,4 | 29,4 | 22,2 | 22,2 | 23,7 | 23,7 | 20,1 | 20,1 | 14,4 |
| 56 | 26,2 | 62,5 | 26,4 | 55,5 | 26,6 | 44,5 | 29,1 | 33,1 | 28,1 | 28,7 | 21,8 | 21,8 | 23,0 | 23,0 | 19,5 | 19,5 | 14,0 |
| 58 | 24,3 | 61,0 | 24,5 | 54,5 | - | - | 27,2 | 32,2 | 26,9 | 28,0 | 21,4 | 21,4 | 22,3 | 22,3 | 18,9 | 18,9 | 13,7 |
| 62 | 21,0 | 58,5 | 21,1 | 52,8 | - | - | 23,7 | 30,5 | 24,1 | 26,8 | 20,7 | 20,7 | 21,0 | 21,0 | 17,9 | 17,9 | 13,1 |
| 63 | 20,3 | 58,0 | 20,3 | 52,5 | - | - | 22,9 | 30,2 | 23,3 | 26,5 | 20,6 | 20,6 | 20,7 | 20,7 | 17,7 | 17,7 | 13,0 |
| 66 | 18,1 | 56,5 | - | - | - | - | 20,6 | 29,1 | 20,9 | 25,7 | 20,2 | 20,2 | 19,8 | 19,8 | 17,0 | 17,0 | 12,6 |
| 68 | - | - | - | - | - | - | 19,3 | 28,5 | 19,6 | 25,2 | 19,9 | 19,9 | 19,3 | 19,3 | 16,6 | 16,6 | 12,3 |
| 70 | - | - | - | - | - | - | 18,0 | 27,9 | 18,3 | 24,8 | - | - | 18,8 | 18,8 | 16,2 | 16,2 | 12,1 |
| 74 | - | - | - | - | - | - | 15,7 | 26,8 | 15,8 | 24,1 | - | - | 17,3 | 17,9 | 15,6 | 15,6 | 11,7 |
| 75 | - | - | - | - | - | - | 15,1 | 26,6 | 15,3 | 24,0 | - | - | 16,8 | 17,7 | 15,4 | 15,4 | 11,6 |
| 77 | - | - | - | - | - | - | 14,1 | 26,2 | - | - | - | - | 15,8 | 17,3 | 15,1 | 15,1 | 11,4 |
| 78 | - | - | - | - | - | - | - | - | - | - | - | - | 15,3 | 17,1 | 15,0 | 15,0 | 11,4 |
| 80 | - | - | - | - | - | - | - | - | - | - | - | - | 14,3 | 16,7 | 14,2 | 14,7 | 11,3 |
| 82 | - | - | - | - | - | - | - | - | - | - | - | - | 13,3 | 16,4 | 13,4 | 14,4 | - |
| 86 | - | - | - | - | - | - | - | - | - | - | - | - | 11,6 | 15,8 | 11,8 | 14,0 | - |
| 89 | - | - | - | - | - | - | - | - | - | - | - | - | 10,4 | 15,4 | - | - | - |

0 t
65 t
125 t
165 t
205 t
265 t
325 t

| | | 165 t + 50 t | | 8,40 m | | 9.8 m/s | | 360° | | ISO | | | |
|----|-------|--------------|-------|---------|------|---------|------|---------|------|---------|------|---------|------|
| | | 66 m | | | | | | | | | | | |
| | | SSL+LF_1 | | | | | | | | | | | |
| | | 12 m | | | | 24 m | | | | 36 m | | | |
| | | 0t-325t | | 0t-325t | | 0t-325t | | 0t-325t | | 0t-325t | | 0t-325t | |
| | | 15° | | 20° | | 30° | | 15° | | 20° | | 30° | |
| m | t | t | t | t | t | t | t | t | t | t | t | t | t |
| 13 | 164,0 | 164,0 | - | - | - | - | - | - | - | - | - | - | - |
| 14 | 158,0 | 158,0 | 121,0 | 121,0 | - | - | - | - | - | - | - | - | - |
| 16 | 148,0 | 148,0 | 114,0 | 114,0 | 74,5 | 74,5 | - | - | - | - | - | - | - |
| 17 | 142,0 | 143,5 | 111,0 | 111,0 | 73,0 | 73,0 | 79,5 | 79,5 | - | - | - | - | - |
| 18 | 136,0 | 139,0 | 108,0 | 108,0 | 71,5 | 71,5 | 77,0 | 77,0 | - | - | - | - | - |
| 19 | 128,5 | 134,5 | 105,5 | 105,5 | 70,2 | 70,2 | 74,7 | 74,7 | 58,0 | 58,0 | - | - | - |
| 20 | 121,0 | 130,0 | 103,0 | 103,0 | 69,0 | 69,0 | 72,5 | 72,5 | 56,5 | 56,5 | - | - | - |
| 21 | 115,0 | 126,5 | 100,7 | 100,7 | 68,0 | 68,0 | 70,2 | 70,2 | 55,0 | 55,0 | 49,1 | 49,3 | - |
| 22 | 109,0 | 123,0 | 98,5 | 98,5 | 67,0 | 67,0 | 68,0 | 68,0 | 53,5 | 53,5 | 47,7 | 47,9 | - |
| 23 | 104,0 | 120,0 | 96,2 | 96,2 | 65,7 | 65,7 | 66,2 | 66,2 | 52,2 | 52,2 | 34,8 | 34,8 | 46,4 |
| 24 | 99,0 | 117,0 | 94,0 | 94,0 | 64,5 | 64,5 | 64,5 | 64,5 | 51,0 | 51,0 | 34,1 | 34,1 | 45,1 |
| 26 | 90,0 | 111,0 | 90,5 | 90,5 | 62,5 | 62,5 | 61,0 | 61,0 | 49,1 | 49,1 | 33,0 | 33,0 | 42,8 |
| 28 | 82,0 | 106,0 | 83,0 | 86,5 | 60,5 | 60,5 | 58,0 | 58,0 | 47,0 | 47,0 | 31,9 | 31,9 | 40,8 |
| 30 | 74,0 | 101,0 | 74,5 | 83,5 | 59,0 | 59,0 | 55,5 | 55,5 | 45,1 | 45,1 | 30,8 | 30,8 | 38,9 |
| 34 | 61,6 | 93,3 | 62,1 | 77,8 | 56,0 | 56,0 | 50,9 | 50,9 | 41,8 | 41,8 | 29,0 | 29,0 | 35,6 |
| 38 | 51,4 | 86,5 | 51,9 | 72,8 | 51,1 | 53,3 | 46,9 | 46,9 | 38,9 | 38,9 | 27,4 | 27,4 | 32,6 |
| 42 | 43,3 | 80,5 | 43,7 | 68,5 | 44,4 | 51,0 | 43,3 | 43,3 | 36,3 | 36,3 | 26,0 | 26,0 | 29,9 |
| 46 | 37,3 | 75,5 | 37,6 | 64,8 | 38,2 | 49,2 | 39,2 | 40,4 | 34,1 | 34,1 | 24,8 | 24,8 | 27,8 |
| 50 | 31,8 | 71,0 | 32,1 | 61,6 | 32,6 | 47,5 | 34,8 | 37,8 | 32,2 | 32,2 | 23,7 | 23,7 | 26,0 |
| 54 | 27,0 | 67,0 | 27,3 | 59,0 | 27,7 | 46,1 | 30,2 | 35,6 | 30,5 | 30,5 | 22,7 | 22,7 | 24,6 |
| 58 | 23,2 | 64,0 | 23,5 | 56,6 | 23,8 | 44,9 | 26,2 | 33,6 | 26,7 | 29,1 | 21,9 | 21,9 | 23,2 |
| 61 | 20,6 | 61,9 | 20,8 | 55,0 | 21,1 | 44,2 | 23,5 | 32,3 | 24,0 | 28,1 | 21,3 | 21,3 | 22,2 |
| 62 | 19,9 | 61,3 | 20,1 | 54,6 | - | - | 22,7 | 31,9 | 23,2 | 27,8 | 21,2 | 21,2 | 21,9 |
| 66 | 16,9 | 59,0 | 17,1 | 53,0 | - | - | 19,6 | 30,4 | 20,0 | 26,6 | 20,6 | 20,6 | 20,7 |
| 68 | 15,7 | 58,0 | 15,8 | 52,0 | - | - | 18,3 | 29,7 | 18,6 | 26,1 | 19,2 | 20,3 | 19,6 |
| 70 | 14,5 | 57,0 | - | - | - | - | 17,0 | 29,1 | 17,3 | 25,6 | 17,8 | 20,1 | 18,6 |
| 71 | 13,9 | 56,5 | - | - | - | - | 16,3 | 28,8 | 16,6 | 25,4 | 17,1 | 20,0 | 18,1 |
| 72 | - | - | - | - | - | - | 15,7 | 28,5 | 16,0 | 25,2 | 16,5 | 19,9 | 17,6 |
| 74 | - | - | - | - | - | - | 14,6 | 28,0 | 14,9 | 24,8 | - | - | 16,5 |
| 78 | - | - | - | - | - | - | 12,5 | 27,0 | 12,7 | 24,2 | - | - | 14,3 |
| 80 | - | - | - | - | - | - | 11,6 | 26,6 | 11,8 | 23,9 | - | - | 13,3 |
| 82 | - | - | - | - | - | - | 10,7 | 26,2 | - | - | - | - | 12,3 |
| 84 | - | - | - | - | - | - | - | - | - | - | - | - | 11,4 |
| 86 | - | - | - | - | - | - | - | - | - | - | - | - | 10,6 |
| 90 | - | - | - | - | - | - | - | - | - | - | - | - | 9,0 |
| 91 | - | - | - | - | - | - | - | - | - | - | - | - | 8,6 |
| 94 | - | - | - | - | - | - | - | - | - | - | - | - | 7,6 |



| | | 165 t + 50 t | | 8,40 m | | 9.8 m/s | | 360° | | ISO | | | |
|----|-------|--------------|-------|---------|------|---------|------|---------|------|---------|------|---------|------|
| | | 72 m | | | | | | | | | | | |
| | | SSL+LF_1 | | | | | | | | | | | |
| | | 12 m | | | | 24 m | | | | 36 m | | | |
| | | 0t-325t | | 0t-325t | | 0t-325t | | 0t-325t | | 0t-325t | | 0t-325t | |
| | | 15° | | 20° | | 30° | | 15° | | 20° | | 30° | |
| m | t | t | t | t | t | t | t | t | t | t | t | t | t |
| 13 | 167,0 | 167,0 | - | - | - | - | - | - | - | - | - | - | - |
| 14 | 162,0 | 162,0 | 122,0 | 122,0 | - | - | - | - | - | - | - | - | - |
| 16 | 148,0 | 151,0 | 116,0 | 116,0 | 75,0 | 75,0 | - | - | - | - | - | - | - |
| 17 | 139,5 | 146,5 | 113,0 | 113,0 | 73,7 | 73,7 | 81,0 | 81,0 | - | - | - | - | - |
| 18 | 131,0 | 142,0 | 110,0 | 110,0 | 72,5 | 72,5 | 78,5 | 78,5 | - | - | - | - | - |
| 19 | 124,0 | 138,0 | 107,5 | 107,5 | 71,2 | 71,2 | 76,2 | 76,2 | 58,5 | 58,5 | - | - | - |
| 20 | 117,0 | 134,0 | 105,0 | 105,0 | 70,0 | 70,0 | 74,0 | 74,0 | 57,0 | 57,0 | - | - | - |
| 21 | 111,0 | 130,5 | 103,0 | 103,0 | 68,7 | 68,7 | 72,0 | 72,0 | 55,7 | 55,7 | - | - | - |
| 22 | 105,0 | 127,0 | 101,0 | 101,0 | 67,5 | 67,5 | 70,0 | 70,0 | 54,5 | 54,5 | - | - | - |
| 23 | 100,0 | 124,0 | 98,5 | 98,7 | 66,5 | 66,5 | 68,0 | 68,0 | 53,2 | 53,2 | 35,0 | 35,0 | 46,9 |
| 24 | 95,0 | 121,0 | 96,0 | 96,5 | 65,5 | 65,5 | 66,0 | 66,0 | 52,0 | 52,0 | 34,4 | 34,4 | 45,7 |
| 26 | 86,5 | 115,0 | 87,5 | 93,0 | 63,5 | 63,5 | 63,0 | 63,0 | 50,0 | 50,0 | 33,3 | 33,3 | 43,4 |
| 28 | 79,0 | 110,0 | 79,5 | 89,0 | 62,0 | 62,0 | 60,0 | 60,0 | 48,0 | 48,0 | 32,2 | 32,2 | 41,4 |
| 30 | 72,0 | 105,0 | 73,0 | 86,0 | 60,0 | 60,0 | 57,0 | 57,0 | 46,1 | 46,1 | 31,2 | 31,2 | 39,6 |
| 34 | 60,0 | 97,0 | 60,6 | 80,3 | 57,0 | 57,0 | 52,3 | 52,3 | 42,9 | 42,9 | 29,4 | 29,4 | 36,4 |
| 38 | 49,9 | 90,0 | 50,4 | 75,3 | 51,3 | 54,3 | 48,3 | 48,3 | 40,0 | 40,0 | 27,9 | 27,9 | 33,4 |
| 42 | 41,8 | 84,0 | 42,2 | 71,0 | 43,0 | 52,0 | 45,0 | 45,0 | 37,4 | 37,4 | 26,5 | 26,5 | 30,8 |
| 46 | 35,5 | 79,0 | 35,9 | 67,3 | 36,6 | 50,2 | 38,9 | 42,0 | 35,2 | 35,2 | 25,3 | 25,3 | 28,6 |
| 50 | 30,0 | 74,5 | 30,3 | 64,0 | 31,0 | 48,6 | 33,4 | 39,4 | 32,5 | 33,3 | 24,2 | 24,2 | 26,8 |
| 54 | 25,2 | 70,5 | 25,5 | 61,0 | 26,0 | 47,1 | 28,6 | 37,1 | 29,2 | 31,6 | 23,2 | 23,2 | 25,2 |
| 58 | 21,4 | 67,1 | 21,6 | 58,6 | 22,0 | 45,8 | 24,6 | 35,1 | 25,2 | 30,1 | 22,4 | 22,4 | 23,9 |
| 62 | 18,0 | 64,1 | 18,2 | 56,5 | 18,5 | 44,7 | 21,1 | 33,3 | 21,6 | 28,7 | 21,0 | 21,6 | 22,2 |
| 65 | 15,7 | 62,1 | 15,9 | 55,0 | 16,2 | 44,1 | 18,7 | 32,1 | 19,2 | 27,8 | 19,6 | 21,1 | 20,6 |
| 66 | 15,0 | 61,5 | 15,2 | 54,5 | - | - | 17,9 | 31,7 | 18,4 | 27,5 | 19,2 | 21,0 | 20,1 |
| 70 | 12,5 | 59,1 | 12,7 | 53,1 | - | - | 15,3 | 30,3 | 15,7 | 26,5 | 16,4 | 20,4 | 17,4 |
| 73 | 10,8 | 57,6 | 10,9 | 52,0 | - | - | 13,4 | 29,3 | 13,8 | 25,8 | 14,4 | 20,1 | 15,5 |
| 74 | 10,3 | 57,2 | - | - | - | - | 12,9 | 29,0 | 13,3 | 25,6 | 13,8 | 20,0 | 14,9 |
| 76 | 9,3 | 56,5 | - | - | - | - | 11,8 | 28,5 | 12,2 | 25,2 | 12,6 | 19,8 | 13,8 |
| 77 | - | - | - | - | - | - | 11,3 | 28,2 | 11,6 | 25,0 | 10,9 | 19,7 | 13,2 |
| 78 | - | - | - | - | - | - | 10,8 | 28,0 | 11,1 | 24,8 | - | - | 12,7 |
| 82 | - | - | - | - | - | - | 8,9 | 27,0 | 9,2 | 24,2 | - | - | 10,8 |
| 85 | - | - | - | - | - | - | 7,6 | 26,4 | 7,8 | 23,8 | - | - | 9,4 |
| 86 | - | - | - | - | - | - | 7,2 | 26,3 | - | - | - | - | 9,0 |
| 88 | - | - | - | - | - | - | 6,5 | 26,0 | - | - | - | - | 8,2 |
| 90 | - | - | - | - | - | - | - | - | - | - | - | - | 7,4 |
| 94 | - | - | - | - | - | - | - | - | - | - | - | - | 6,0 |
| 96 | - | - | - | - | - | - | - | - | - | - | - | - | 5,3 |
| 98 | - | - | - | - | - | - | - | - | - | - | - | - | 4,6 |
| 99 | - | - | - | - | - | - | - | - | - | - | - | - | 4,3 |



| 165 t + 50 t | | 8,40 m | | 9.8 m/s | | 360° | | ISO | | | | | | | | | | | |
|--------------|-------|--------|-------|---------|------|-------|------|------|------|-------|------|------|------|-------|------|------|------|-------|--|
| 78 m | | | | | | | | | | | | | | | | | | | |
| SSL+LF_1 | | | | | | | | | | | | | | | | | | | |
| 12 m | | | | | | 24 m | | | | | | 36 m | | | | | | | |
| 0 t | | 325 t | | 0 t | | 325 t | | 0 t | | 325 t | | 0 t | | 325 t | | 0 t | | 325 t | |
| 15° | | 20° | | 30° | | 15° | | 20° | | 30° | | 15° | | 20° | | 30° | | | |
| m | t | t | t | t | t | t | t | t | t | t | t | t | t | t | t | t | t | | |
| 14 | 163,0 | 165,0 | - | - | - | - | - | - | - | - | - | - | - | - | - | - | - | | |
| 15 | 153,0 | 160,0 | 121,0 | 121,0 | - | - | - | - | - | - | - | - | - | - | - | - | - | | |
| 16 | 143,0 | 155,0 | 118,0 | 118,0 | - | - | - | - | - | - | - | - | - | - | - | - | - | | |
| 17 | 135,0 | 150,5 | 115,0 | 115,0 | 74,5 | 74,5 | - | - | - | - | - | - | - | - | - | - | - | | |
| 18 | 127,0 | 146,0 | 112,0 | 112,0 | 73,0 | 73,0 | 80,0 | 80,0 | - | - | - | - | - | - | - | - | - | | |
| 20 | 113,0 | 138,0 | 107,0 | 107,0 | 70,5 | 70,5 | 75,5 | 75,5 | 58,0 | 58,0 | - | - | - | - | - | - | - | | |
| 22 | 102,0 | 131,0 | 103,0 | 103,0 | 68,5 | 68,5 | 71,5 | 71,5 | 55,5 | 55,5 | - | - | 48,3 | 48,6 | - | - | - | | |
| 24 | 92,0 | 124,0 | 93,0 | 99,0 | 66,5 | 66,5 | 67,5 | 67,5 | 53,0 | 53,0 | 34,6 | 34,6 | 45,9 | 46,2 | - | - | - | | |
| 25 | 88,0 | 121,5 | 88,7 | 97,0 | 65,5 | 65,5 | 66,0 | 66,0 | 52,0 | 52,0 | 34,0 | 34,0 | 44,8 | 45,1 | 35,6 | 35,8 | - | | |
| 26 | 84,0 | 119,0 | 84,5 | 95,0 | 64,5 | 64,5 | 64,5 | 64,5 | 51,0 | 51,0 | 33,5 | 33,5 | 43,8 | 44,0 | 34,9 | 35,1 | - | | |
| 28 | 76,5 | 113,0 | 77,5 | 91,5 | 63,0 | 63,0 | 61,5 | 61,5 | 48,9 | 48,9 | 32,5 | 32,5 | 41,8 | 42,1 | 33,5 | 33,7 | - | | |
| 30 | 70,0 | 109,0 | 71,0 | 88,5 | 61,0 | 61,0 | 58,5 | 58,5 | 47,1 | 47,1 | 31,5 | 31,5 | 40,1 | 40,3 | 32,2 | 32,4 | - | | |
| 31 | 67,2 | 107,0 | 68,1 | 87,0 | 60,0 | 60,3 | 57,4 | 57,4 | 46,3 | 46,3 | 31,0 | 31,0 | 39,3 | 39,5 | 31,6 | 31,8 | 20,6 | | |
| 34 | 59,0 | 101,0 | 59,6 | 82,8 | 57,0 | 58,3 | 54,1 | 54,1 | 43,9 | 43,9 | 29,8 | 29,8 | 36,9 | 37,1 | 30,0 | 30,1 | 19,7 | | |
| 38 | 49,4 | 93,6 | 49,8 | 77,6 | 50,8 | 55,6 | 49,5 | 50,1 | 41,0 | 41,0 | 28,3 | 28,3 | 34,1 | 34,3 | 27,9 | 28,0 | 18,6 | | |
| 42 | 41,2 | 87,0 | 41,6 | 73,0 | 42,4 | 53,0 | 44,6 | 46,5 | 38,4 | 38,4 | 26,9 | 26,9 | 31,5 | 31,7 | 26,1 | 26,2 | 17,6 | | |
| 46 | 34,8 | 82,0 | 35,2 | 69,3 | 36,0 | 51,3 | 38,4 | 43,5 | 36,2 | 36,2 | 25,7 | 25,7 | 29,3 | 29,5 | 24,5 | 24,6 | 16,7 | | |
| 50 | 29,2 | 77,3 | 29,6 | 66,0 | 30,3 | 49,7 | 32,8 | 40,9 | 32,9 | 34,3 | 24,6 | 24,6 | 27,5 | 27,6 | 23,0 | 23,1 | 15,9 | | |
| 54 | 24,4 | 73,0 | 24,7 | 63,0 | 25,3 | 48,1 | 27,8 | 38,5 | 28,5 | 32,5 | 23,6 | 23,6 | 25,9 | 26,0 | 21,8 | 21,9 | 15,1 | | |
| 58 | 20,6 | 69,6 | 20,8 | 60,6 | 21,3 | 46,7 | 23,8 | 36,5 | 24,5 | 31,0 | 22,8 | 22,8 | 24,6 | 24,7 | 20,8 | 20,8 | 14,5 | | |
| 62 | 17,1 | 66,6 | 17,4 | 58,3 | 17,8 | 45,6 | 20,3 | 34,6 | 20,8 | 29,6 | 21,1 | 22,0 | 22,4 | 23,5 | 19,8 | 19,8 | 13,9 | | |
| 66 | 14,1 | 64,0 | 14,4 | 56,0 | 14,7 | 44,6 | 17,1 | 32,9 | 17,6 | 28,4 | 18,5 | 21,4 | 19,4 | 22,3 | 18,8 | 18,8 | 13,4 | | |
| 69 | 12,3 | 62,0 | 12,5 | 55,0 | 12,7 | 44,0 | 15,1 | 31,8 | 15,6 | 27,6 | 16,4 | 20,9 | 17,3 | 21,5 | 17,4 | 18,2 | 13,0 | | |
| 70 | 11,7 | 61,3 | 11,8 | 54,6 | - | - | 14,5 | 31,5 | 14,9 | 27,3 | 15,7 | 20,8 | 16,6 | 21,2 | 16,9 | 18,0 | 12,9 | | |
| 74 | 9,4 | 59,1 | 9,6 | 53,3 | - | - | 12,1 | 30,2 | 12,5 | 26,3 | 13,1 | 20,3 | 14,2 | 20,2 | 14,8 | 17,2 | 12,5 | | |
| 78 | 7,4 | 57,5 | 7,6 | 52,0 | - | - | 10,0 | 29,0 | 10,3 | 25,5 | 10,9 | 19,9 | 12,0 | 19,3 | 12,5 | 16,5 | 12,1 | | |
| 81 | 6,1 | 56,5 | - | - | - | - | 8,6 | 28,2 | 8,9 | 25,0 | 9,3 | 19,6 | 10,5 | 18,7 | 11,0 | 16,0 | 11,2 | | |
| 82 | - | - | - | - | - | - | 8,1 | 28,0 | 8,4 | 24,8 | - | - | 10,0 | 18,5 | 10,5 | 15,9 | 10,9 | | |
| 86 | - | - | - | - | - | - | 6,4 | 27,1 | 6,7 | 24,2 | - | - | 8,2 | 17,7 | 8,7 | 15,3 | 9,5 | | |
| 90 | - | - | - | - | - | - | 4,9 | 26,4 | 4,8 | 23,7 | - | - | 6,6 | 17,0 | 7,0 | 14,9 | 7,7 | | |
| 93 | - | - | - | - | - | - | 3,9 | 25,9 | - | - | - | - | 5,5 | 16,6 | 5,9 | 14,5 | 5,2 | | |
| 94 | - | - | - | - | - | - | - | - | - | - | - | - | 5,2 | 16,4 | 5,5 | 14,4 | - | | |
| 98 | - | - | - | - | - | - | - | - | - | - | - | - | 3,8 | 15,9 | 4,1 | 14,1 | - | | |
| 99 | - | - | - | - | - | - | - | - | - | - | - | - | 3,5 | 15,8 | 3,8 | 14,0 | - | | |
| 101 | - | - | - | - | - | - | - | - | - | - | - | - | - | 15,6 | - | 13,9 | - | | |
| 102 | - | - | - | - | - | - | - | - | - | - | - | - | - | 15,5 | - | - | - | | |
| 104 | - | - | - | - | - | - | - | - | - | - | - | - | - | 15,3 | - | - | - | | |



| 165 t + 50 t | | 8,40 m | | 9.8 m/s | | 360° | | ISO | | | | | | | | | |
|--------------|-------|-------------|-------|-------------|------|-------------|------|-------------|------|-------------|------|-------------|------|-------------|------|-------------|------|
| 84 m | | | | | | | | | | | | | | | | | |
| SSL+LF_1 | | | | | | | | | | | | | | | | | |
| 12 m | | | | | | 24 m | | | | | | 36 m | | | | | |
| 0 t - 325 t | | 0 t - 325 t | | 0 t - 325 t | | 0 t - 325 t | | 0 t - 325 t | | 0 t - 325 t | | 0 t - 325 t | | 0 t - 325 t | | 0 t - 325 t | |
| 15° | | 20° | | 30° | | 15° | | 20° | | 30° | | 15° | | 20° | | 30° | |
| m | t | t | t | t | t | t | t | t | t | t | t | t | t | t | t | t | t |
| 14 | 157,0 | 167,0 | - | - | - | - | - | - | - | - | - | - | - | - | - | - | - |
| 15 | 147,0 | 162,5 | 122,0 | 122,0 | - | - | - | - | - | - | - | - | - | - | - | - | - |
| 16 | 137,0 | 158,0 | 119,0 | 119,0 | - | - | - | - | - | - | - | - | - | - | - | - | - |
| 17 | 129,5 | 153,5 | 116,5 | 116,5 | 74,5 | 74,5 | - | - | - | - | - | - | - | - | - | - | - |
| 18 | 122,0 | 149,0 | 114,0 | 114,0 | 73,5 | 73,5 | 80,5 | 81,0 | - | - | - | - | - | - | - | - | - |
| 20 | 109,0 | 141,0 | 109,0 | 109,0 | 71,5 | 71,5 | 76,5 | 76,5 | 58,5 | 58,5 | - | - | - | - | - | - | - |
| 22 | 98,0 | 134,0 | 99,0 | 105,0 | 69,0 | 69,0 | 72,5 | 72,5 | 56,0 | 56,0 | - | - | 48,6 | 48,9 | - | - | - |
| 24 | 88,5 | 128,0 | 89,5 | 101,0 | 67,0 | 67,0 | 69,0 | 69,0 | 53,5 | 53,5 | 34,8 | 34,8 | 46,3 | 46,6 | - | - | - |
| 26 | 80,5 | 122,0 | 81,5 | 97,0 | 65,5 | 65,5 | 66,0 | 66,0 | 51,5 | 51,5 | 33,7 | 33,7 | 44,2 | 44,5 | 35,1 | 35,2 | - |
| 28 | 73,0 | 117,0 | 74,0 | 93,5 | 63,5 | 63,5 | 63,0 | 63,0 | 49,8 | 49,8 | 32,8 | 32,8 | 42,3 | 42,6 | 33,7 | 33,9 | - |
| 30 | 67,0 | 112,0 | 68,0 | 90,5 | 62,0 | 62,0 | 60,0 | 60,0 | 48,0 | 48,0 | 31,8 | 31,8 | 40,6 | 40,9 | 32,5 | 32,6 | - |
| 31 | 64,5 | 110,0 | 65,4 | 89,0 | 60,6 | 61,3 | 58,9 | 58,9 | 47,2 | 47,2 | 31,4 | 31,4 | 39,8 | 40,1 | 31,9 | 32,0 | 20,6 |
| 34 | 57,0 | 104,0 | 57,6 | 84,8 | 56,6 | 59,3 | 55,6 | 55,6 | 44,8 | 44,8 | 30,2 | 30,2 | 37,6 | 37,8 | 30,3 | 30,4 | 19,7 |
| 38 | 47,8 | 96,8 | 48,4 | 79,8 | 49,7 | 56,6 | 49,9 | 51,6 | 41,9 | 41,9 | 28,7 | 28,7 | 34,8 | 35,0 | 28,3 | 28,5 | 18,7 |
| 42 | 39,6 | 90,5 | 40,2 | 75,5 | 41,1 | 54,0 | 42,9 | 48,0 | 39,3 | 39,3 | 27,3 | 27,3 | 32,3 | 32,4 | 26,5 | 26,7 | 17,7 |
| 46 | 33,1 | 85,1 | 33,6 | 71,8 | 34,5 | 52,3 | 36,8 | 45,0 | 36,3 | 37,1 | 26,1 | 26,1 | 30,1 | 30,2 | 24,9 | 25,1 | 16,8 |
| 50 | 27,4 | 80,3 | 27,8 | 68,3 | 28,6 | 50,6 | 31,2 | 42,2 | 32,2 | 35,2 | 25,0 | 25,0 | 28,2 | 28,3 | 23,5 | 23,6 | 16,0 |
| 54 | 22,5 | 76,0 | 22,9 | 65,0 | 23,6 | 49,0 | 26,2 | 39,8 | 27,0 | 33,5 | 24,1 | 24,1 | 26,5 | 26,7 | 22,3 | 22,4 | 15,3 |
| 58 | 18,7 | 72,3 | 19,0 | 62,3 | 19,6 | 47,6 | 22,2 | 37,7 | 22,9 | 31,9 | 22,7 | 23,2 | 24,0 | 25,4 | 21,2 | 21,3 | 14,7 |
| 62 | 15,2 | 69,0 | 15,5 | 60,0 | 16,1 | 46,3 | 18,7 | 35,8 | 19,2 | 30,5 | 20,4 | 22,4 | 21,1 | 24,2 | 20,0 | 20,3 | 14,1 |
| 66 | 12,2 | 66,0 | 12,5 | 58,0 | 12,9 | 45,3 | 15,5 | 34,1 | 16,0 | 29,3 | 17,0 | 21,7 | 17,9 | 23,0 | 18,7 | 19,4 | 13,6 |
| 70 | 9,7 | 63,6 | 9,9 | 56,3 | 10,3 | 44,5 | 12,8 | 32,6 | 13,3 | 28,1 | 14,2 | 21,1 | 15,1 | 21,9 | 15,9 | 18,5 | 13,1 |
| 74 | 7,5 | 61,5 | 7,6 | 54,6 | 7,1 | 43,7 | 10,4 | 31,3 | 10,9 | 27,1 | 11,6 | 20,6 | 12,6 | 20,9 | 13,4 | 17,7 | 12,6 |
| 78 | 5,5 | 59,5 | 5,6 | 53,0 | - | - | 8,3 | 30,1 | 8,7 | 26,3 | 9,3 | 20,2 | 10,4 | 20,0 | 11,1 | 17,0 | 12,2 |
| 82 | 3,7 | 57,7 | 3,9 | 52,2 | - | - | 6,4 | 29,0 | 6,7 | 25,5 | 7,3 | 19,8 | 8,4 | 19,1 | 9,1 | 16,4 | 10,1 |
| 83 | - | 57,3 | - | 52,0 | - | - | 5,9 | 28,7 | 6,2 | 25,3 | 6,8 | 19,7 | 7,9 | 18,9 | 8,6 | 16,2 | 9,6 |
| 85 | - | 56,7 | - | - | - | - | 5,1 | 28,3 | 5,4 | 24,9 | 5,9 | 19,6 | 7,1 | 18,5 | 7,6 | 15,9 | 8,6 |
| 86 | - | 56,5 | - | - | - | - | 4,7 | 28,0 | 5,0 | 24,8 | - | - | 6,7 | 18,3 | 7,2 | 15,8 | 8,1 |
| 89 | - | - | - | - | - | - | 3,5 | 27,4 | 3,8 | 24,3 | - | - | 5,5 | 17,8 | 5,9 | 15,4 | 6,7 |
| 90 | - | - | - | - | - | - | - | 27,2 | - | 24,2 | - | - | 5,1 | 17,7 | 5,5 | 15,3 | 6,3 |
| 94 | - | - | - | - | - | - | - | 26,4 | - | 23,7 | - | - | 3,6 | 17,0 | 3,9 | 14,8 | 4,7 |
| 95 | - | - | - | - | - | - | - | 26,2 | - | 23,6 | - | - | - | 16,8 | 3,6 | 14,7 | 4,3 |
| 97 | - | - | - | - | - | - | - | 26,0 | - | - | - | - | - | 16,5 | - | 14,5 | 3,6 |
| 98 | - | - | - | - | - | - | - | 25,9 | - | - | - | - | - | 16,4 | - | 14,4 | - |
| 102 | - | - | - | - | - | - | - | - | - | - | - | - | - | 16,0 | - | 14,1 | - |
| 106 | - | - | - | - | - | - | - | - | - | - | - | - | - | 15,6 | - | 13,8 | - |
| 109 | - | - | - | - | - | - | - | - | - | - | - | - | - | 15,3 | - | - | - |



| 165 t + 50 t | | 8,40 m | | 9.8 m/s | | 360° | | ISO | | | | | | | | | | | |
|--------------|-------|---------|-------|---------|------|---------|------|------|------|---------|------|------|------|---------|------|------|------|---------|--|
| 90 m | | | | | | | | | | | | | | | | | | | |
| SSL+LF_1 | | | | | | | | | | | | | | | | | | | |
| 12 m | | | | | | 24 m | | | | | | 36 m | | | | | | | |
| 0 t | | 0t-325t | | 0 t | | 0t-325t | | 0 t | | 0t-325t | | 0 t | | 0t-325t | | 0 t | | 0t-325t | |
| 15° | | 20° | | 30° | | 15° | | 20° | | 30° | | 15° | | 20° | | 30° | | | |
| m | t | t | t | t | t | t | t | t | t | t | t | t | t | t | t | t | t | | |
| 15 | 141,0 | 165,0 | - | - | - | - | - | - | - | - | - | - | - | - | - | - | - | | |
| 16 | 132,0 | 160,0 | 121,0 | 121,0 | - | - | - | - | - | - | - | - | - | - | - | - | - | | |
| 18 | 117,0 | 152,0 | 116,0 | 116,0 | 74,0 | 74,0 | - | - | - | - | - | - | - | - | - | - | - | | |
| 19 | 110,5 | 148,0 | 111,0 | 113,5 | 73,0 | 73,0 | 79,5 | 80,0 | - | - | - | - | - | - | - | - | - | | |
| 20 | 104,0 | 144,0 | 106,0 | 111,0 | 72,0 | 72,0 | 77,5 | 77,5 | - | - | - | - | - | - | - | - | - | | |
| 21 | 99,0 | 140,5 | 100,5 | 109,0 | 71,0 | 71,0 | 75,7 | 75,7 | 58,0 | 58,0 | - | - | - | - | - | - | - | | |
| 22 | 94,0 | 137,0 | 95,0 | 107,0 | 70,0 | 70,0 | 74,0 | 74,0 | 56,5 | 56,5 | - | - | - | - | - | - | - | | |
| 23 | 89,5 | 134,0 | 90,5 | 105,0 | 69,0 | 69,0 | 72,2 | 72,2 | 55,5 | 55,5 | - | - | 47,7 | 48,0 | - | - | - | | |
| 24 | 85,0 | 131,0 | 86,0 | 103,0 | 68,0 | 68,0 | 70,5 | 70,5 | 54,5 | 54,5 | - | - | 46,6 | 46,9 | - | - | - | | |
| 25 | 81,0 | 128,0 | 82,0 | 101,0 | 67,0 | 67,0 | 68,7 | 68,7 | 53,5 | 53,5 | 34,4 | 34,4 | 45,6 | 45,9 | - | - | - | | |
| 26 | 77,0 | 125,0 | 78,0 | 99,0 | 66,0 | 66,0 | 67,0 | 67,0 | 52,5 | 52,5 | 33,9 | 33,9 | 44,6 | 44,9 | 35,2 | 35,4 | - | | |
| 28 | 70,0 | 120,0 | 71,0 | 95,5 | 64,5 | 64,5 | 64,5 | 64,5 | 50,5 | 50,5 | 33,0 | 33,0 | 42,8 | 43,0 | 33,9 | 34,1 | - | | |
| 30 | 64,0 | 115,0 | 65,0 | 92,5 | 63,0 | 63,0 | 61,5 | 61,5 | 48,8 | 48,8 | 32,1 | 32,1 | 41,1 | 41,3 | 32,7 | 32,9 | - | | |
| 32 | 59,2 | 111,0 | 60,0 | 89,6 | 59,1 | 61,5 | 58,0 | 59,1 | 47,2 | 47,2 | 31,3 | 31,3 | 39,6 | 39,8 | 31,6 | 31,8 | 20,3 | | |
| 34 | 54,4 | 107,0 | 55,0 | 86,8 | 55,3 | 60,0 | 54,5 | 56,8 | 45,6 | 45,6 | 30,5 | 30,5 | 38,1 | 38,4 | 30,6 | 30,8 | 19,7 | | |
| 38 | 45,7 | 99,8 | 46,2 | 81,8 | 47,6 | 57,3 | 47,5 | 52,8 | 42,8 | 42,8 | 29,0 | 29,0 | 35,4 | 35,7 | 28,7 | 28,9 | 18,7 | | |
| 42 | 38,1 | 93,5 | 38,7 | 77,5 | 39,8 | 55,0 | 40,7 | 49,4 | 40,2 | 40,2 | 27,6 | 27,6 | 33,0 | 33,2 | 26,9 | 27,1 | 17,8 | | |
| 46 | 31,5 | 88,1 | 32,1 | 73,8 | 33,0 | 53,0 | 35,2 | 46,4 | 35,6 | 38,0 | 26,4 | 26,4 | 30,8 | 31,0 | 25,3 | 25,5 | 17,0 | | |
| 50 | 25,8 | 83,3 | 26,3 | 70,3 | 27,1 | 51,3 | 29,9 | 43,6 | 30,8 | 36,1 | 25,4 | 25,4 | 28,9 | 29,1 | 23,9 | 24,1 | 16,2 | | |
| 54 | 20,9 | 79,0 | 21,4 | 67,0 | 22,1 | 49,9 | 24,8 | 41,1 | 25,7 | 34,3 | 24,4 | 24,4 | 27,2 | 27,4 | 22,7 | 22,8 | 15,5 | | |
| 58 | 17,1 | 75,3 | 17,4 | 64,3 | 18,1 | 48,5 | 20,8 | 39,0 | 21,5 | 32,7 | 22,0 | 23,6 | 23,4 | 26,0 | 21,6 | 21,8 | 14,9 | | |
| 62 | 13,6 | 71,8 | 13,9 | 61,8 | 14,5 | 47,2 | 17,2 | 37,1 | 17,8 | 31,3 | 19,1 | 22,8 | 19,8 | 24,7 | 19,9 | 20,8 | 14,3 | | |
| 66 | 10,6 | 68,5 | 10,9 | 59,5 | 11,4 | 46,0 | 14,0 | 35,3 | 14,6 | 30,1 | 15,7 | 22,1 | 16,6 | 23,6 | 17,5 | 19,9 | 13,8 | | |
| 70 | 8,1 | 65,8 | 8,3 | 57,8 | 8,8 | 45,0 | 11,4 | 33,7 | 11,9 | 28,9 | 12,9 | 21,5 | 13,8 | 22,6 | 14,7 | 19,0 | 13,3 | | |
| 74 | 5,8 | 63,5 | 6,0 | 56,2 | 6,4 | 44,2 | 9,0 | 32,3 | 9,4 | 27,9 | 10,3 | 20,9 | 11,3 | 21,6 | 12,1 | 18,2 | 12,4 | | |
| 78 | 3,8 | 61,5 | 4,0 | 54,5 | 4,3 | 43,6 | 6,8 | 31,1 | 7,2 | 27,0 | 8,0 | 20,5 | 9,0 | 20,7 | 9,8 | 17,5 | 11,0 | | |
| 82 | - | 59,5 | - | 53,1 | - | - | 4,9 | 30,0 | 5,2 | 26,2 | 6,0 | 20,1 | 7,0 | 19,8 | 7,8 | 16,8 | 8,9 | | |
| 85 | - | 58,1 | - | 52,2 | - | - | 3,6 | 29,2 | 3,9 | 25,6 | 4,5 | 19,8 | 5,6 | 19,2 | 6,3 | 16,3 | 7,4 | | |
| 86 | - | 57,8 | - | 52,0 | - | - | - | 28,9 | - | 25,4 | 4,0 | 19,7 | 5,2 | 19,0 | 5,9 | 16,2 | 6,9 | | |
| 87 | - | 57,5 | - | 51,7 | - | - | - | 28,7 | - | 25,3 | 3,6 | 19,6 | 4,8 | 18,8 | 5,5 | 16,1 | 6,5 | | |
| 88 | - | 57,1 | - | 51,5 | - | - | - | 28,4 | - | 25,1 | - | 19,5 | 4,4 | 18,6 | 5,0 | 16,0 | 6,0 | | |
| 90 | - | 56,5 | - | - | - | - | - | 28,0 | - | 24,8 | - | 19,4 | 3,6 | 18,3 | 4,2 | 15,7 | 5,1 | | |
| 91 | - | 56,0 | - | - | - | - | - | 27,8 | - | 24,6 | - | - | - | 18,1 | 3,8 | 15,6 | 4,7 | | |
| 93 | - | - | - | - | - | - | - | 27,4 | - | 24,4 | - | - | - | 17,8 | - | 15,3 | 3,9 | | |
| 94 | - | - | - | - | - | - | - | 27,2 | - | 24,2 | - | - | - | 17,6 | - | 15,2 | - | | |
| 98 | - | - | - | - | - | - | - | 26,5 | - | 23,8 | - | - | - | 17,0 | - | 14,8 | - | | |
| 100 | - | - | - | - | - | - | - | 26,2 | - | 23,6 | - | - | - | 16,7 | - | 14,6 | - | | |
| 101 | - | - | - | - | - | - | - | 26,0 | - | - | - | - | - | 16,6 | - | 14,5 | - | | |
| 102 | - | - | - | - | - | - | - | 25,9 | - | - | - | - | - | 16,5 | - | 14,4 | - | | |
| 103 | - | - | - | - | - | - | - | 25,8 | - | - | - | - | - | 16,3 | - | 14,3 | - | | |
| 106 | - | - | - | - | - | - | - | - | - | - | - | - | - | 16,0 | - | 14,0 | - | | |
| 110 | - | - | - | - | - | - | - | - | - | - | - | - | - | 15,6 | - | 13,7 | - | | |
| 111 | - | - | - | - | - | - | - | - | - | - | - | - | - | 15,5 | - | 13,7 | - | | |
| 114 | - | - | - | - | - | - | - | - | - | - | - | - | - | 15,3 | - | - | - | | |
| 115 | - | - | - | - | - | - | - | - | - | - | - | - | - | 15,2 | - | - | - | | |



| 165 t + 50 t | | 8,40 m | | 9.8 m/s | | 360° | | ISO | | | | | | | | | | | |
|--------------|-------|---------|-------|---------|------|---------|------|---------|------|---------|------|---------|------|---------|------|---------|------|---------|---|
| 96 m | | | | | | | | | | | | | | | | | | | |
| SSL+LF_1 | | | | | | | | | | | | | | | | | | | |
| 12 m | | | | | | 24 m | | | | | | 36 m | | | | | | | |
| 0t-325t | | 0t-325t | | 0t-325t | | 0t-325t | | 0t-325t | | 0t-325t | | 0t-325t | | 0t-325t | | 0t-325t | | 0t-325t | |
| 15° | | 20° | | 30° | | 15° | | 20° | | 30° | | 15° | | 20° | | 30° | | | |
| m | t | t | t | t | t | t | t | t | t | t | t | t | t | t | t | t | t | t | t |
| 15 | 135,0 | 167,0 | - | - | - | - | - | - | - | - | - | - | - | - | - | - | - | - | - |
| 16 | 127,0 | 163,0 | 122,0 | 122,0 | - | - | - | - | - | - | - | - | - | - | - | - | - | - | - |
| 18 | 112,0 | 155,0 | 114,0 | 117,0 | 74,5 | 74,5 | - | - | - | - | - | - | - | - | - | - | - | - | - |
| 19 | 106,0 | 151,0 | 108,0 | 114,5 | 73,5 | 73,5 | 80,0 | 80,5 | - | - | - | - | - | - | - | - | - | - | - |
| 20 | 100,0 | 147,0 | 102,0 | 112,0 | 72,5 | 72,5 | 78,0 | 78,5 | - | - | - | - | - | - | - | - | - | - | - |
| 21 | 95,0 | 143,5 | 96,7 | 110,0 | 71,5 | 71,5 | 76,2 | 76,7 | 58,5 | 58,5 | - | - | - | - | - | - | - | - | - |
| 22 | 90,0 | 140,0 | 91,5 | 108,0 | 70,5 | 70,5 | 74,5 | 75,0 | 57,0 | 57,0 | - | - | - | - | - | - | - | - | - |
| 23 | 85,7 | 137,0 | 87,0 | 106,0 | 69,5 | 69,5 | 73,0 | 73,2 | 56,0 | 56,0 | - | - | 48,0 | 48,3 | - | - | - | - | - |
| 24 | 81,5 | 134,0 | 82,5 | 104,0 | 68,5 | 68,5 | 71,5 | 71,5 | 55,0 | 55,0 | - | - | 46,9 | 47,3 | - | - | - | - | - |
| 25 | 77,5 | 131,0 | 78,5 | 102,5 | 67,7 | 67,7 | 70,0 | 70,0 | 54,0 | 54,0 | 34,6 | 34,6 | 45,9 | 46,3 | - | - | - | - | - |
| 26 | 73,5 | 128,0 | 74,5 | 101,0 | 67,0 | 67,0 | 68,5 | 68,5 | 53,0 | 53,0 | 34,1 | 34,1 | 45,0 | 45,3 | - | - | - | - | - |
| 27 | 70,2 | 125,5 | 71,2 | 99,2 | 66,0 | 66,0 | 67,0 | 67,0 | 52,0 | 52,0 | 33,6 | 33,6 | 44,1 | 44,4 | 34,7 | 34,9 | - | - | - |
| 28 | 67,0 | 123,0 | 68,0 | 97,5 | 65,0 | 65,0 | 65,5 | 65,5 | 51,0 | 51,0 | 33,2 | 33,2 | 43,2 | 43,5 | 34,1 | 34,3 | - | - | - |
| 30 | 61,0 | 118,0 | 62,0 | 94,5 | 63,5 | 63,5 | 62,5 | 63,0 | 49,5 | 49,5 | 32,3 | 32,3 | 41,5 | 41,8 | 33,0 | 33,1 | - | - | - |
| 32 | 56,2 | 114,0 | 57,1 | 91,6 | 58,6 | 62,1 | 57,9 | 60,6 | 47,9 | 47,9 | 31,5 | 31,5 | 40,1 | 40,3 | 31,9 | 32,1 | 20,3 | 20,4 | - |
| 34 | 51,5 | 110,0 | 52,3 | 88,8 | 53,7 | 60,8 | 53,3 | 58,3 | 46,4 | 46,4 | 30,7 | 30,7 | 38,7 | 38,9 | 30,9 | 31,1 | 19,8 | 19,8 | - |
| 38 | 43,2 | 102,8 | 43,9 | 83,8 | 45,2 | 58,3 | 45,3 | 54,1 | 43,1 | 43,6 | 29,3 | 29,3 | 36,0 | 36,2 | 29,0 | 29,2 | 18,8 | 18,8 | - |
| 42 | 36,2 | 96,5 | 36,8 | 79,5 | 37,9 | 56,0 | 38,3 | 50,5 | 39,5 | 41,1 | 28,0 | 28,0 | 33,6 | 33,8 | 27,3 | 27,5 | 17,9 | 18,0 | - |
| 46 | 29,7 | 91,1 | 30,3 | 75,5 | 31,3 | 54,0 | 32,8 | 47,5 | 33,9 | 38,9 | 26,8 | 26,8 | 31,5 | 31,7 | 25,8 | 25,9 | 17,1 | 17,2 | - |
| 50 | 24,0 | 86,1 | 24,6 | 72,0 | 25,5 | 52,1 | 27,8 | 44,8 | 28,8 | 37,0 | 25,8 | 25,8 | 28,7 | 29,8 | 24,4 | 24,5 | 16,3 | 16,4 | - |
| 54 | 19,1 | 81,5 | 19,6 | 69,0 | 20,4 | 50,5 | 23,2 | 42,4 | 24,1 | 35,2 | 24,8 | 24,8 | 25,2 | 28,0 | 23,1 | 23,2 | 15,7 | 15,7 | - |
| 58 | 15,2 | 77,8 | 15,6 | 66,3 | 16,4 | 49,2 | 19,2 | 40,2 | 20,0 | 33,6 | 21,2 | 23,9 | 21,6 | 26,6 | 21,7 | 22,1 | 15,0 | 15,1 | - |
| 62 | 11,7 | 74,3 | 12,1 | 63,8 | 12,8 | 48,0 | 15,5 | 38,2 | 16,3 | 32,1 | 17,6 | 23,1 | 18,3 | 25,3 | 19,3 | 21,1 | 14,4 | 14,5 | - |
| 66 | 8,7 | 71,0 | 9,0 | 61,5 | 9,6 | 46,8 | 12,3 | 36,4 | 13,0 | 30,9 | 14,2 | 22,5 | 15,1 | 24,3 | 16,1 | 20,3 | 14,0 | 14,0 | - |
| 70 | 6,1 | 68,3 | 6,4 | 59,5 | 7,0 | 45,8 | 9,7 | 34,8 | 10,2 | 29,7 | 11,4 | 21,8 | 12,3 | 23,2 | 13,2 | 19,5 | 13,5 | 13,5 | - |
| 74 | 3,8 | 65,9 | 4,0 | 57,6 | 4,5 | 44,9 | 7,2 | 33,4 | 7,7 | 28,6 | 8,8 | 21,2 | 9,7 | 22,2 | 10,6 | 18,7 | 12,1 | 13,1 | - |
| 75 | - | 65,3 | 3,5 | 57,2 | 4,0 | 44,7 | 6,7 | 33,1 | 7,2 | 28,4 | 8,2 | 21,1 | 9,2 | 22,0 | 10,0 | 18,5 | 11,5 | 13,0 | - |
| 78 | - | 63,5 | - | 56,0 | - | 44,1 | 5,0 | 32,1 | 5,5 | 27,7 | 6,4 | 20,7 | 7,5 | 21,3 | 8,3 | 18,0 | 9,7 | 12,7 | - |
| 81 | - | 62,0 | - | 55,0 | - | 43,6 | 3,6 | 31,2 | 4,0 | 27,0 | 4,9 | 20,4 | 6,0 | 20,6 | 6,7 | 17,5 | 8,1 | 12,4 | - |
| 82 | - | 61,5 | - | 54,6 | - | 43,5 | - | 30,9 | 3,6 | 26,8 | 4,4 | 20,3 | 5,5 | 20,4 | 6,2 | 17,3 | 7,5 | 12,3 | - |
| 83 | - | 61,0 | - | 54,3 | - | 43,4 | - | 30,6 | - | 26,6 | 3,9 | 20,2 | 5,0 | 20,2 | 5,7 | 17,1 | 7,0 | 12,2 | - |
| 86 | - | 59,6 | - | 53,3 | - | - | - | 29,9 | - | 26,0 | - | 19,9 | 3,7 | 19,6 | 4,3 | 16,7 | 5,5 | 12,0 | - |
| 87 | - | 59,2 | - | 53,0 | - | - | - | 29,6 | - | 25,8 | - | 19,8 | - | 19,4 | 3,9 | 16,5 | 5,1 | 11,9 | - |
| 90 | - | 58,0 | - | 52,0 | - | - | - | 28,9 | - | 25,3 | - | 19,6 | - | 18,9 | - | 16,1 | 3,7 | 11,7 | - |
| 94 | - | 56,6 | - | 43,8 | - | - | - | 28,0 | - | 24,7 | - | 19,3 | - | 18,2 | - | 15,6 | - | 11,4 | - |
| 97 | - | 56,0 | - | - | - | - | - | 27,4 | - | 24,3 | - | - | - | 17,7 | - | 15,2 | - | 11,2 | - |
| 98 | - | - | - | - | - | - | - | 27,2 | - | 24,2 | - | - | - | 17,6 | - | 15,1 | - | 11,2 | - |
| 102 | - | - | - | - | - | - | - | 26,6 | - | 23,7 | - | - | - | 17,0 | - | 14,7 | - | 11,0 | - |
| 105 | - | - | - | - | - | - | - | 26,2 | - | 23,5 | - | - | - | 16,6 | - | 14,4 | - | 10,9 | - |
| 106 | - | - | - | - | - | - | - | 26,0 | - | - | - | - | - | 16,4 | - | 14,4 | - | 10,9 | - |
| 108 | - | - | - | - | - | - | - | 25,8 | - | - | - | - | - | 16,2 | - | 14,2 | - | - | - |
| 110 | - | - | - | - | - | - | - | - | - | - | - | - | - | 16,0 | - | 14,1 | - | - | - |
| 114 | - | - | - | - | - | - | - | - | - | - | - | - | - | 15,6 | - | 13,8 | - | - | - |
| 116 | - | - | - | - | - | - | - | - | - | - | - | - | - | 15,5 | - | 13,7 | - | - | - |
| 118 | - | - | - | - | - | - | - | - | - | - | - | - | - | 15,3 | - | - | - | - | - |
| 120 | - | - | - | - | - | - | - | - | - | - | - | - | - | 15,2 | - | - | - | - | - |

0t
65t
125t
165t
205t
265t
325t

| | | 165 t + 50 t | | 8,40 m | | 9.8 m/s | | 360° | | ISO | | | | | | | |
|-----|-------|--------------|-------|---------|------|---------|------|---------|------|---------|------|---------|------|---------|------|--|--|
| | | 102 m | | | | | | | | | | | | | | | |
| | | SSL+LF_1 | | | | | | | | | | | | | | | |
| | | 12 m | | | | 24 m | | | | 36 m | | | | | | | |
| | | 0t-325t | | 0t-325t | | 0t-325t | | 0t-325t | | 0t-325t | | 0t-325t | | 0t-325t | | | |
| | | 15° | | 20° | | 30° | | 15° | | 20° | | 30° | | 15° | | | |
| m | t | t | t | t | t | t | t | t | t | t | t | t | t | t | t | | |
| 16 | 122,0 | 161,0 | - | - | - | - | - | - | - | - | - | - | - | - | - | | |
| 17 | 115,0 | 159,0 | 116,0 | 121,0 | - | - | - | - | - | - | - | - | - | - | - | | |
| 18 | 108,0 | 157,0 | 109,0 | 118,0 | - | - | - | - | - | - | - | - | - | - | - | | |
| 19 | 102,2 | 153,5 | 103,5 | 116,0 | 73,5 | 73,5 | - | - | - | - | - | - | - | - | - | | |
| 20 | 96,5 | 150,0 | 98,0 | 114,0 | 72,5 | 72,5 | 78,5 | 79,0 | - | - | - | - | - | - | - | | |
| 22 | 86,5 | 143,0 | 87,5 | 110,0 | 71,0 | 71,0 | 75,0 | 76,0 | 57,5 | 57,5 | - | - | - | - | - | | |
| 24 | 78,0 | 137,0 | 79,0 | 106,0 | 69,0 | 69,0 | 72,0 | 72,5 | 55,5 | 55,5 | - | - | 47,2 | 47,5 | - | | |
| 26 | 70,5 | 131,0 | 71,5 | 102,0 | 67,5 | 67,5 | 69,5 | 69,5 | 53,5 | 53,5 | 34,2 | 34,2 | 45,3 | 45,6 | - | | |
| 27 | 67,2 | 128,5 | 68,2 | 100,5 | 66,7 | 66,7 | 67,5 | 68,0 | 52,5 | 52,5 | 33,7 | 33,7 | 44,4 | 44,7 | 34,8 | | |
| 28 | 64,0 | 126,0 | 65,0 | 99,0 | 66,0 | 66,0 | 65,5 | 66,5 | 51,5 | 51,5 | 33,3 | 33,3 | 43,5 | 43,8 | 34,3 | | |
| 30 | 58,0 | 121,0 | 59,0 | 96,0 | 61,0 | 64,5 | 60,0 | 64,0 | 50,0 | 50,0 | 32,5 | 32,5 | 41,9 | 42,2 | 33,1 | | |
| 33 | 51,1 | 115,0 | 52,0 | 92,0 | 53,7 | 62,2 | 53,2 | 60,7 | 47,8 | 47,8 | 31,3 | 31,3 | 39,8 | 40,1 | 31,6 | | |
| 34 | 48,8 | 113,0 | 49,6 | 90,6 | 51,3 | 61,5 | 50,9 | 59,6 | 47,0 | 47,0 | 30,9 | 30,9 | 39,1 | 39,4 | 31,1 | | |
| 38 | 40,7 | 105,6 | 41,5 | 85,6 | 42,9 | 59,0 | 42,9 | 55,5 | 42,8 | 44,3 | 29,5 | 29,5 | 36,6 | 36,9 | 29,3 | | |
| 42 | 33,8 | 99,0 | 34,5 | 81,0 | 35,7 | 57,0 | 36,1 | 51,5 | 37,3 | 41,8 | 28,3 | 28,3 | 34,2 | 34,5 | 27,7 | | |
| 46 | 27,8 | 93,6 | 28,5 | 77,3 | 29,6 | 55,0 | 30,7 | 48,7 | 31,8 | 39,6 | 27,1 | 27,1 | 31,2 | 32,3 | 26,2 | | |
| 50 | 22,4 | 88,6 | 23,0 | 73,8 | 24,0 | 53,1 | 25,8 | 46,1 | 26,9 | 37,7 | 25,8 | 26,1 | 27,5 | 30,4 | 24,8 | | |
| 54 | 17,5 | 84,0 | 18,0 | 70,5 | 18,9 | 51,5 | 21,6 | 43,5 | 22,5 | 35,9 | 24,3 | 25,1 | 23,3 | 28,7 | 23,5 | | |
| 58 | 13,6 | 80,3 | 14,0 | 67,8 | 14,8 | 50,0 | 17,6 | 41,3 | 18,5 | 34,3 | 20,1 | 24,3 | 19,7 | 27,2 | 20,6 | | |
| 62 | 10,1 | 76,8 | 10,5 | 65,3 | 11,2 | 48,7 | 14,0 | 39,3 | 14,9 | 32,9 | 16,3 | 23,5 | 16,5 | 25,9 | 17,7 | | |
| 66 | 7,0 | 73,5 | 7,4 | 63,0 | 8,0 | 47,5 | 10,8 | 37,5 | 11,6 | 31,6 | 12,9 | 22,8 | 13,7 | 24,8 | 14,7 | | |
| 70 | 4,4 | 70,7 | 4,8 | 61,0 | 5,3 | 46,4 | 8,1 | 35,9 | 8,8 | 30,4 | 10,0 | 22,1 | 10,9 | 23,8 | 11,9 | | |
| 71 | 3,8 | 70,0 | 4,1 | 60,5 | 4,6 | 46,2 | 7,4 | 35,5 | 8,1 | 30,1 | 9,3 | 21,9 | 10,2 | 23,5 | 11,2 | | |
| 72 | - | 69,0 | 3,5 | 60,0 | 4,0 | 45,9 | 6,8 | 35,1 | 7,5 | 29,8 | 8,6 | 21,8 | 9,6 | 23,3 | 10,5 | | |
| 74 | - | 67,8 | - | 59,0 | - | 45,4 | 5,6 | 34,4 | 6,3 | 29,3 | 7,4 | 21,5 | 8,4 | 22,8 | 9,3 | | |
| 77 | - | 66,0 | - | 57,5 | - | 44,8 | 4,0 | 33,4 | 4,5 | 28,6 | 5,6 | 21,1 | 6,6 | 22,1 | 7,5 | | |
| 78 | - | 65,5 | - | 57,0 | - | 44,6 | - | 33,1 | 4,0 | 28,3 | 5,0 | 21,0 | 6,1 | 21,9 | 6,9 | | |
| 79 | - | 65,0 | - | 56,6 | - | 44,4 | - | 32,8 | 3,5 | 28,1 | 4,4 | 20,9 | 5,6 | 21,6 | 6,4 | | |
| 80 | - | 64,5 | - | 56,3 | - | 44,2 | - | 32,5 | - | 27,8 | 3,9 | 20,8 | 5,1 | 21,4 | 5,9 | | |
| 82 | - | 63,5 | - | 55,6 | - | 43,9 | - | 31,9 | - | 27,4 | - | 20,6 | 4,1 | 21,0 | 4,9 | | |
| 83 | - | 63,0 | - | 55,3 | - | 43,7 | - | 31,6 | - | 27,2 | - | 20,5 | 3,6 | 20,8 | 4,4 | | |
| 84 | - | 62,5 | - | 55,0 | - | 43,6 | - | 31,3 | - | 27,0 | - | 20,4 | - | 20,6 | 3,9 | | |
| 86 | - | 61,5 | - | 54,3 | - | 43,3 | - | 30,7 | - | 26,6 | - | 20,2 | - | 20,2 | - | | |
| 87 | - | 61,0 | - | 54,0 | - | 43,2 | - | 30,5 | - | 26,4 | - | 20,1 | - | 20,0 | - | | |
| 90 | - | 59,5 | - | 53,0 | - | - | - | 29,7 | - | 25,9 | - | 19,8 | - | 19,4 | - | | |
| 94 | - | 57,8 | - | 52,0 | - | - | - | 28,8 | - | 25,3 | - | 19,5 | - | 18,7 | - | | |
| 98 | - | 55,0 | - | 51,5 | - | - | - | 28,0 | - | 24,7 | - | 19,3 | - | 18,1 | - | | |
| 99 | - | 54,0 | - | 43,7 | - | - | - | 27,8 | - | 24,6 | - | - | - | 17,9 | - | | |
| 102 | - | 51,0 | - | - | - | - | - | 27,3 | - | 24,2 | - | - | - | 17,5 | - | | |
| 106 | - | - | - | - | - | - | - | 26,6 | - | 23,8 | - | - | - | 16,9 | - | | |
| 110 | - | - | - | - | - | - | - | 26,0 | - | 23,4 | - | - | - | 16,4 | - | | |
| 113 | - | - | - | - | - | - | - | 25,7 | - | - | - | - | - | 16,1 | - | | |
| 114 | - | - | - | - | - | - | - | - | - | - | - | - | - | 16,0 | - | | |
| 118 | - | - | - | - | - | - | - | - | - | - | - | - | - | 15,6 | - | | |
| 121 | - | - | - | - | - | - | - | - | - | - | - | - | - | 15,4 | - | | |
| 122 | - | - | - | - | - | - | - | - | - | - | - | - | - | 15,3 | - | | |
| 125 | - | - | - | - | - | - | - | - | - | - | - | - | - | 15,1 | - | | |

0t
65t
125t
165t
205t
265t
325t

| | | 165 t + 50 t | | 8,40 m | | 9.8 m/s | | 360° | | ISO | | | | | | | | | |
|-----|-------|--------------|-------|---------|------|---------|------|---------|------|---------|------|---------|------|---------|------|---------|------|---------|---|
| | | 108 m | | | | | | | | | | | | | | | | | |
| | | SSL+LF_1 | | | | | | | | | | | | | | | | | |
| | | 12 m | | | | | | 24 m | | | | | | 36 m | | | | | |
| | | 0t-325t | | 0t-325t | | 0t-325t | | 0t-325t | | 0t-325t | | 0t-325t | | 0t-325t | | 0t-325t | | 0t-325t | |
| | | 15° | | 20° | | 30° | | 15° | | 20° | | 30° | | 15° | | 20° | | 30° | |
| m | t | t | t | t | t | t | t | t | t | t | t | t | t | t | t | t | t | t | t |
| 16 | 117,0 | 154,0 | - | - | - | - | - | - | - | - | - | - | - | - | - | - | - | - | - |
| 17 | 110,0 | 154,0 | 111,0 | 122,0 | - | - | - | - | - | - | - | - | - | - | - | - | - | - | - |
| 18 | 103,0 | 154,0 | 105,0 | 119,0 | - | - | - | - | - | - | - | - | - | - | - | - | - | - | - |
| 19 | 97,5 | 152,0 | 99,2 | 117,0 | 74,0 | 74,0 | - | - | - | - | - | - | - | - | - | - | - | - | - |
| 20 | 92,0 | 150,0 | 93,5 | 115,0 | 73,0 | 73,0 | 79,0 | 79,5 | - | - | - | - | - | - | - | - | - | - | - |
| 22 | 82,5 | 145,0 | 84,0 | 111,0 | 71,5 | 71,5 | 75,5 | 76,5 | 58,0 | 58,0 | - | - | - | - | - | - | - | - | - |
| 24 | 74,5 | 139,0 | 75,5 | 107,0 | 69,5 | 69,5 | 73,0 | 73,5 | 56,0 | 56,0 | - | - | 47,3 | 47,7 | - | - | - | - | - |
| 26 | 67,0 | 134,0 | 68,0 | 104,0 | 68,0 | 68,0 | 69,0 | 70,5 | 54,0 | 54,0 | 34,4 | 34,4 | 45,6 | 45,9 | - | - | - | - | - |
| 28 | 60,5 | 129,0 | 61,5 | 101,0 | 64,0 | 66,5 | 62,5 | 68,0 | 52,5 | 52,5 | 33,5 | 33,5 | 43,9 | 44,2 | 34,4 | 34,6 | - | - | - |
| 30 | 55,0 | 124,0 | 56,0 | 97,5 | 58,0 | 65,0 | 57,0 | 65,0 | 50,5 | 50,5 | 32,7 | 32,7 | 42,3 | 42,6 | 33,3 | 33,5 | - | - | - |
| 33 | 48,2 | 118,0 | 49,1 | 93,5 | 50,9 | 63,0 | 50,4 | 61,7 | 47,9 | 48,4 | 31,5 | 31,5 | 40,2 | 40,5 | 31,8 | 32,0 | 20,1 | 20,1 | - |
| 34 | 46,0 | 116,0 | 46,8 | 92,1 | 48,5 | 62,3 | 48,2 | 60,6 | 47,0 | 47,7 | 31,1 | 31,1 | 39,5 | 39,8 | 31,3 | 31,5 | 19,8 | 19,8 | - |
| 38 | 38,0 | 108,6 | 38,8 | 87,3 | 40,2 | 59,8 | 40,4 | 56,6 | 41,8 | 45,0 | 29,7 | 29,7 | 37,0 | 37,3 | 29,6 | 29,8 | 18,9 | 18,9 | - |
| 42 | 31,2 | 102,0 | 31,9 | 83,0 | 33,2 | 57,5 | 33,6 | 53,0 | 35,0 | 42,6 | 28,5 | 28,5 | 34,8 | 35,0 | 28,0 | 28,2 | 18,1 | 18,1 | - |
| 46 | 25,8 | 96,3 | 26,4 | 79,0 | 27,6 | 55,5 | 28,3 | 50,0 | 29,6 | 40,4 | 27,4 | 27,4 | 29,9 | 33,0 | 26,5 | 26,7 | 17,3 | 17,3 | - |
| 50 | 20,6 | 91,1 | 21,2 | 75,3 | 22,3 | 53,6 | 23,6 | 47,2 | 24,7 | 38,5 | 25,3 | 26,4 | 25,4 | 31,1 | 24,7 | 25,3 | 16,5 | 16,6 | - |
| 54 | 15,6 | 86,5 | 16,2 | 72,0 | 17,1 | 52,0 | 19,4 | 44,7 | 20,4 | 36,7 | 22,2 | 25,4 | 21,2 | 29,3 | 22,6 | 24,1 | 15,9 | 16,0 | - |
| 58 | 11,7 | 82,5 | 12,2 | 69,3 | 13,1 | 50,6 | 15,8 | 42,5 | 16,8 | 35,1 | 18,4 | 24,6 | 17,7 | 27,8 | 19,0 | 23,0 | 15,3 | 15,4 | - |
| 62 | 8,2 | 78,8 | 8,6 | 66,8 | 9,4 | 49,4 | 12,4 | 40,4 | 13,3 | 33,6 | 14,8 | 23,8 | 14,5 | 26,5 | 15,7 | 22,0 | 14,7 | 14,8 | - |
| 66 | 5,1 | 75,5 | 5,5 | 64,5 | 6,2 | 48,2 | 9,1 | 38,6 | 9,9 | 32,3 | 11,4 | 23,1 | 11,6 | 25,3 | 12,8 | 21,1 | 14,3 | 14,3 | - |
| 68 | 3,8 | 74,2 | 4,1 | 63,5 | 4,8 | 47,6 | 7,7 | 37,8 | 8,5 | 31,7 | 9,9 | 22,7 | 10,3 | 24,8 | 11,5 | 20,7 | 13,1 | 14,1 | - |
| 69 | - | 73,4 | - | 63,0 | 4,1 | 47,3 | 7,1 | 37,4 | 7,8 | 31,4 | 9,2 | 22,6 | 9,7 | 24,6 | 10,8 | 20,5 | 12,5 | 14,0 | - |
| 70 | - | 72,6 | - | 62,5 | - | 47,0 | 6,4 | 37,0 | 7,1 | 31,1 | 8,5 | 22,4 | 9,1 | 24,3 | 10,2 | 20,3 | 11,9 | 13,9 | - |
| 74 | - | 69,8 | - | 60,5 | - | 46,0 | 3,9 | 35,4 | 4,6 | 30,0 | 5,8 | 21,8 | 6,7 | 23,4 | 7,7 | 19,6 | 9,5 | 13,5 | - |
| 75 | - | 69,2 | - | 60,0 | - | 45,8 | - | 35,1 | 4,0 | 29,7 | 5,2 | 21,7 | 6,2 | 23,2 | 7,1 | 19,4 | 8,9 | 13,4 | - |
| 77 | - | 68,0 | - | 59,0 | - | 45,4 | - | 34,3 | - | 29,2 | 4,0 | 21,4 | 5,0 | 22,7 | 5,9 | 19,0 | 7,7 | 13,2 | - |
| 78 | - | 67,5 | - | 58,5 | - | 45,2 | - | 34,0 | - | 29,0 | - | 21,3 | 4,5 | 22,5 | 5,4 | 18,8 | 7,1 | 13,1 | - |
| 79 | - | 66,9 | - | 58,0 | - | 45,0 | - | 33,7 | - | 28,7 | - | 21,1 | 4,0 | 22,3 | 4,8 | 18,6 | 6,5 | 13,0 | - |
| 81 | - | 65,7 | - | 57,2 | - | 44,6 | - | 33,1 | - | 28,3 | - | 20,9 | - | 21,8 | 3,8 | 18,3 | 5,4 | 12,8 | - |
| 82 | - | 65,1 | - | 56,8 | - | 44,4 | - | 32,8 | - | 28,0 | - | 20,8 | - | 21,6 | - | 18,1 | 4,9 | 12,7 | - |
| 84 | - | 64,0 | - | 56,0 | - | 44,1 | - | 32,2 | - | 27,6 | - | 20,6 | - | 21,2 | - | 17,8 | 3,8 | 12,5 | - |
| 86 | - | 63,1 | - | 55,5 | - | 43,8 | - | 31,6 | - | 27,2 | - | 20,4 | - | 20,8 | - | 17,5 | - | 12,3 | - |
| 90 | - | 61,5 | - | 54,5 | - | 43,2 | - | 30,6 | - | 26,5 | - | 20,0 | - | 20,0 | - | 16,9 | - | 12,1 | - |
| 92 | - | 59,3 | - | 53,8 | - | 42,1 | - | 30,1 | - | 26,1 | - | 19,8 | - | 19,6 | - | 16,6 | - | 11,9 | - |
| 94 | - | 57,1 | - | 53,1 | - | - | - | 29,6 | - | 25,8 | - | 19,7 | - | 19,2 | - | 16,3 | - | 11,7 | - |
| 98 | - | 53,6 | - | 52,0 | - | - | - | 28,8 | - | 25,2 | - | 19,4 | - | 18,6 | - | 15,9 | - | 11,5 | - |
| 102 | - | 50,0 | - | 50,0 | - | - | - | 28,0 | - | 24,6 | - | 19,2 | - | 18,0 | - | 15,4 | - | 11,3 | - |
| 103 | - | 49,0 | - | 49,2 | - | - | - | 27,8 | - | 24,5 | - | 19,1 | - | 17,9 | - | 15,3 | - | 11,2 | - |
| 104 | - | 48,0 | - | 48,5 | - | - | - | 27,6 | - | 24,4 | - | - | - | 17,7 | - | 15,2 | - | 11,2 | - |
| 106 | - | 46,0 | - | - | - | - | - | 27,3 | - | 24,1 | - | - | - | 17,4 | - | 15,0 | - | 11,1 | - |
| 107 | - | 45,1 | - | - | - | - | - | 27,1 | - | 24,0 | - | - | - | 17,3 | - | 14,9 | - | 11,0 | - |
| 110 | - | - | - | - | - | - | - | 26,7 | - | 23,7 | - | - | - | 16,9 | - | 14,6 | - | 10,9 | - |
| 114 | - | - | - | - | - | - | - | 26,1 | - | 23,4 | - | - | - | 16,5 | - | 14,3 | - | 10,8 | - |
| 115 | - | - | - | - | - | - | - | 26,0 | - | 23,3 | - | - | - | 16,4 | - | 14,2 | - | - | - |
| 118 | - | - | - | - | - | - | - | 25,7 | - | - | - | - | - | 16,1 | - | 14,0 | - | - | - |
| 119 | - | - | - | - | - | - | - | 25,6 | - | - | - | - | - | 16,0 | - | 13,9 | - | - | - |
| 122 | - | - | - | - | - | - | - | - | - | - | - | - | - | 15,7 | - | 13,8 | - | - | - |
| 126 | - | - | - | - | - | - | - | - | - | - | - | - | - | 15,4 | - | 13,6 | - | - | - |
| 130 | - | - | - | - | - | - | - | - | - | - | - | - | - | 15,1 | - | - | - | - | - |



Notes

CC 3800-1

Notizen · Notes · Nota · Notas · Notas ·
пометы, комментарии, примечания

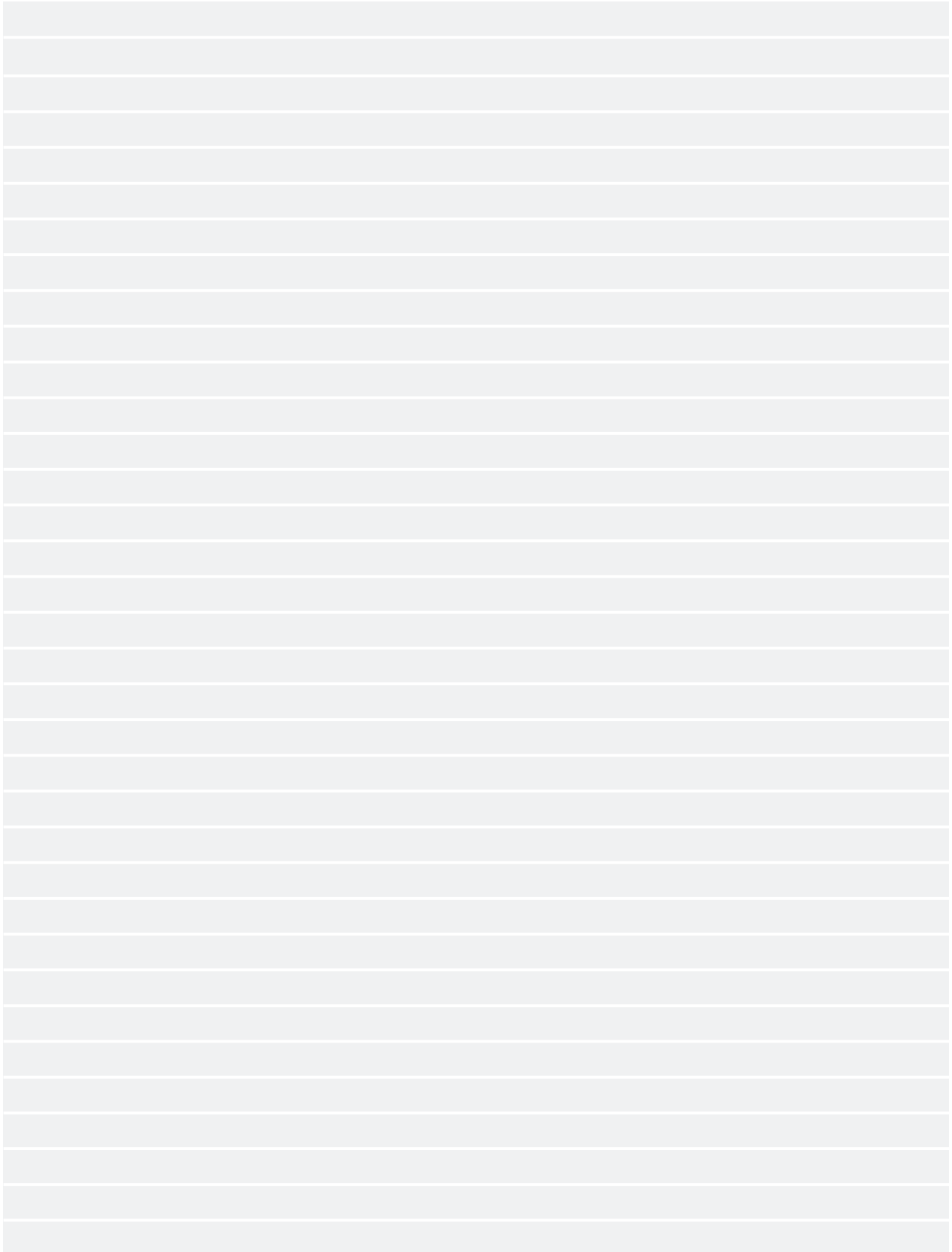

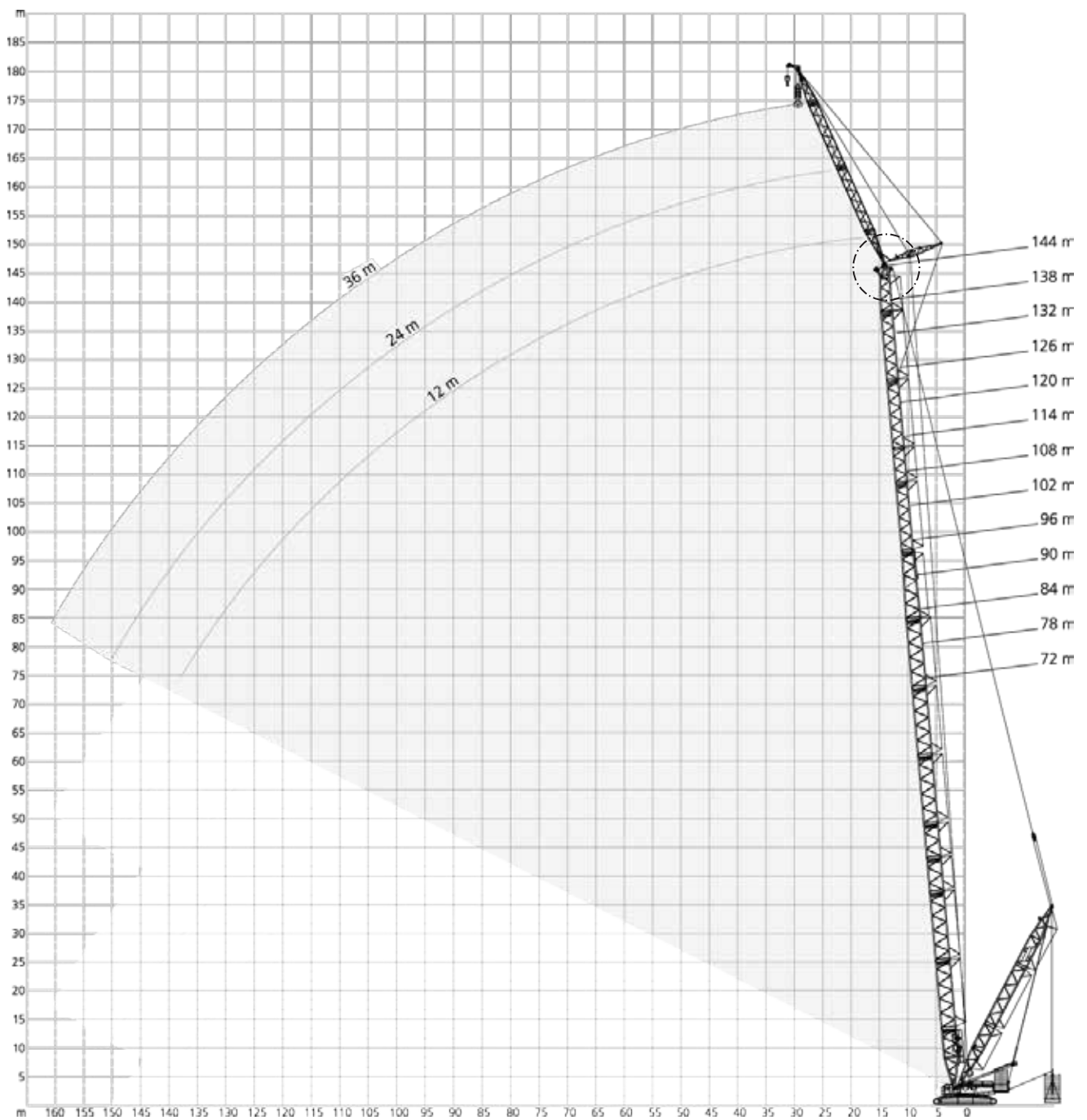
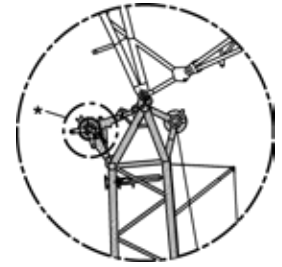

* Attachable · Anbaubar · Amovible · Montabile · Acoplable · Adaptável · Приставн

LSL+LF_3, LSL+LF_4, LSL+LF_6, LSL+LF_8, LSL+LF_10, LSL+LF_12

CC 3800-1

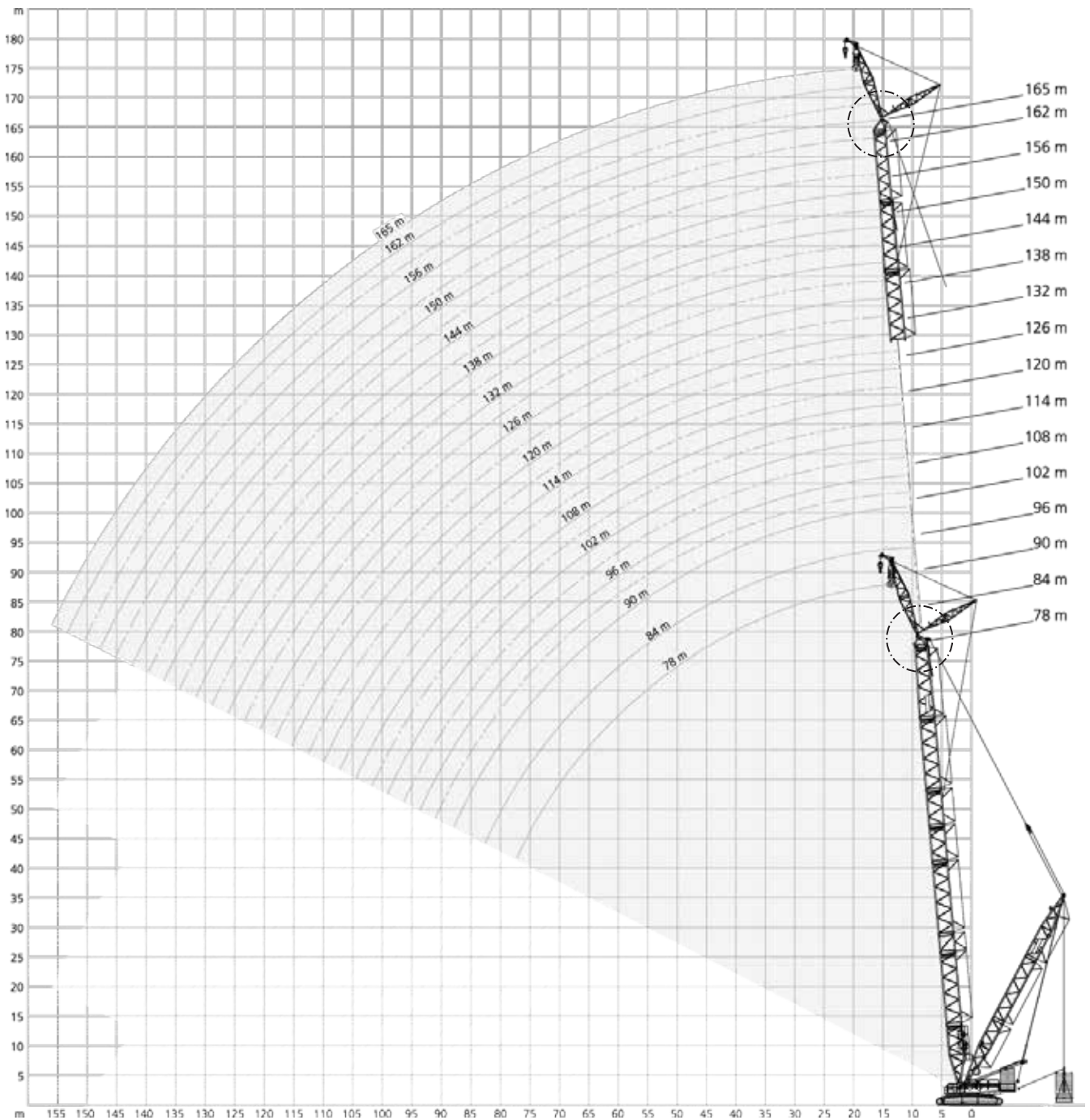
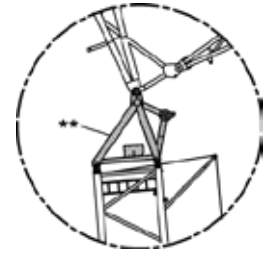

** Option · Option · En option · Opzione · Opcion · Opcional · Опция

| 165 t + 50 t | | 8,40 m | | 9.8 m/s | | 360° | | ISO | | | | | | | | | | | |
|--------------|-------|---------|-------|---------|-------|----------|-------|----------|-------|----------|-------|-------|-------|-------|------|-------|-------|-------|----|
| 72 m | | | | 78 m | | | | 84 m | | | | | | | | | | | |
| LSL+LF_2 | | | | | | LSL+LF_3 | | LSL+LF_2 | | LSL+LF_3 | | | | | | | | | |
| 12 m | | | | | | | | | | | | | | | | | | | |
| 0 t | | 0t-325t | | 0 t | | 0t-325t | | 0 t | | 0t-325t | | | | | | | | | |
| 15° | | 20° | | 30° | | 15° | | 20° | | 30° | | | | | | | | | |
| m | t | t | t | t | t | t | t | t | t | t | t | m | | | | | | | |
| 12 | 178,0 | 178,0 | - | - | - | - | - | - | - | - | - | 12 | | | | | | | |
| 13 | 171,0 | 172,5 | 132,0 | - | 169,0 | 176,0 | - | - | - | 162,0 | 178,0 | 13 | | | | | | | |
| 14 | 164,0 | 167,0 | 128,0 | - | 157,0 | 170,0 | 130,0 | - | 152,0 | 156,0 | 124,0 | 151,0 | 173,0 | 132,0 | - | 149,0 | 155,0 | 126,0 | 14 |
| 15 | 154,0 | 162,0 | 125,0 | 81,5 | 147,5 | 165,0 | 127,0 | - | 144,0 | 152,0 | 121,0 | 142,0 | 168,5 | 129,0 | - | 140,0 | 152,0 | 123,0 | 15 |
| 16 | 144,0 | 157,0 | 122,0 | 80,0 | 138,0 | 160,0 | 124,0 | 81,0 | 136,0 | 148,0 | 118,0 | 133,0 | 164,0 | 126,0 | 81,5 | 131,0 | 149,0 | 120,0 | 16 |
| 18 | 127,0 | 148,0 | 116,0 | 77,5 | 122,0 | 151,0 | 118,0 | 78,0 | 121,0 | 140,0 | 113,0 | 118,0 | 155,0 | 120,0 | 79,0 | 116,0 | 143,0 | 115,0 | 18 |
| 20 | 114,0 | 140,0 | 111,0 | 74,5 | 109,0 | 143,0 | 113,0 | 75,5 | 108,0 | 134,0 | 109,0 | 106,0 | 147,0 | 115,0 | 76,5 | 104,0 | 136,0 | 110,0 | 20 |
| 22 | 103,0 | 132,0 | 106,0 | 72,5 | 98,5 | 136,0 | 108,0 | 73,5 | 98,2 | 127,5 | 104,0 | 95,5 | 140,0 | 111,0 | 74,0 | 94,2 | 130,5 | 106,0 | 22 |
| 24 | 93,5 | 126,0 | 102,0 | 70,0 | 89,5 | 130,0 | 104,0 | 71,0 | 88,5 | 121,0 | 100,0 | 86,5 | 133,0 | 106,0 | 72,0 | 84,5 | 125,0 | 102,0 | 24 |
| 26 | 85,0 | 120,0 | 98,0 | 68,0 | 81,5 | 124,0 | 100,0 | 69,0 | 81,0 | 116,0 | 96,5 | 79,0 | 128,0 | 102,0 | 70,0 | 77,5 | 119,5 | 98,5 | 26 |
| 28 | 78,0 | 115,0 | 94,0 | 66,0 | 74,5 | 119,0 | 96,5 | 67,0 | 73,5 | 111,0 | 93,0 | 72,0 | 122,0 | 99,0 | 68,0 | 70,5 | 114,0 | 95,0 | 28 |
| 30 | 71,5 | 110,0 | 90,5 | 64,0 | 68,5 | 114,0 | 93,5 | 65,5 | 67,7 | 106,5 | 90,0 | 66,0 | 117,0 | 95,5 | 66,5 | 64,7 | 109,5 | 92,0 | 30 |
| 34 | 60,1 | 102,0 | 84,8 | 61,0 | 58,1 | 105,3 | 87,5 | 62,1 | 57,2 | 98,2 | 84,3 | 56,6 | 109,0 | 89,8 | 63,5 | 54,7 | 101,5 | 86,3 | 34 |
| 38 | 50,5 | 94,6 | 79,6 | 58,1 | 49,0 | 97,8 | 82,1 | 59,3 | 48,5 | 91,8 | 79,3 | 48,0 | 101,6 | 84,6 | 60,6 | 46,7 | 95,1 | 81,3 | 38 |
| 42 | 42,6 | 88,0 | 75,0 | 55,5 | 41,1 | 91,5 | 77,5 | 57,0 | 40,5 | 86,5 | 75,0 | 40,2 | 95,0 | 80,0 | 58,0 | 39,1 | 89,5 | 77,0 | 42 |
| 46 | 36,8 | 83,0 | 71,3 | 53,5 | 35,2 | 86,5 | 73,5 | 54,6 | 34,6 | 81,8 | 71,3 | 34,1 | 89,6 | 76,0 | 56,0 | 32,9 | 84,8 | 73,6 | 46 |
| 50 | 31,6 | 78,3 | 67,8 | 51,6 | 29,9 | 81,8 | 70,0 | 52,6 | 29,3 | 77,5 | 67,8 | 28,7 | 84,8 | 72,3 | 54,0 | 27,5 | 80,5 | 70,3 | 50 |
| 54 | 27,0 | 74,0 | 64,5 | 50,0 | 25,2 | 77,5 | 67,0 | 51,0 | 24,7 | 73,5 | 64,5 | 24,1 | 80,5 | 69,0 | 52,0 | 22,9 | 76,5 | 67,0 | 54 |
| 58 | 23,4 | 70,6 | 62,1 | 48,8 | 21,6 | 73,8 | 64,3 | 49,8 | 21,1 | 70,1 | 61,8 | 20,4 | 76,5 | 66,3 | 50,6 | 19,2 | 72,8 | 64,3 | 58 |
| 62 | 20,1 | 67,6 | 60,0 | 47,7 | 18,3 | 70,5 | 61,8 | 48,6 | 17,8 | 67,0 | 59,5 | 17,1 | 73,0 | 63,8 | 49,4 | 15,9 | 69,5 | 61,8 | 62 |
| 65 | 18,0 | 65,6 | 58,5 | 47,0 | 16,1 | 68,2 | 60,0 | 47,7 | 15,7 | 64,7 | 58,0 | 14,9 | 70,7 | 62,0 | 48,5 | 13,8 | 67,2 | 60,0 | 65 |
| 66 | 17,3 | 65,0 | 58,0 | - | 15,4 | 67,5 | 59,5 | 47,5 | 15,0 | 64,0 | 57,5 | 14,2 | 70,0 | 61,5 | 48,3 | 13,1 | 66,5 | 59,5 | 66 |
| 69 | 15,5 | 63,2 | 56,7 | - | 13,6 | 65,7 | 58,2 | 46,9 | 13,2 | 62,2 | 56,2 | 12,4 | 68,0 | 60,0 | 47,6 | 11,3 | 64,5 | 58,0 | 69 |
| 70 | 14,9 | 62,6 | 56,3 | - | 13,0 | 65,1 | 57,8 | - | 12,6 | 61,6 | 55,8 | 11,8 | 67,3 | 59,5 | 47,4 | 10,7 | 63,8 | 57,5 | 70 |
| 73 | 13,3 | 61,1 | 55,5 | - | 11,4 | 63,5 | 56,6 | - | 11,0 | 60,0 | 54,7 | 10,2 | 65,5 | 58,1 | 46,8 | 9,1 | 62,0 | 56,1 | 73 |
| 74 | 12,8 | 60,7 | - | - | 10,9 | 63,0 | 56,3 | - | 10,5 | 59,6 | 54,5 | 9,7 | 65,0 | 57,8 | - | 8,6 | 61,5 | 55,8 | 74 |
| 76 | 11,8 | 60,0 | - | - | 9,9 | 62,0 | 55,6 | - | 9,5 | 58,8 | 54,0 | 8,7 | 64,0 | 57,1 | - | 7,6 | 60,5 | 55,1 | 76 |
| 78 | - | - | - | - | 9,0 | 61,0 | 55,0 | - | 8,6 | 58,0 | 53,5 | 7,7 | 63,0 | 56,5 | - | 6,6 | 59,5 | 54,5 | 78 |
| 81 | - | - | - | - | 7,8 | 60,0 | - | - | 7,4 | 57,0 | - | 6,5 | 61,7 | 55,6 | - | 5,4 | 58,5 | 53,9 | 81 |
| 82 | - | - | - | - | - | - | - | - | - | - | - | 6,1 | 61,3 | 55,3 | - | 5,0 | 58,1 | 53,7 | 82 |
| 83 | - | - | - | - | - | - | - | - | - | - | - | 5,7 | 60,9 | 55,0 | - | 4,6 | 57,8 | 53,5 | 83 |
| 86 | - | - | - | - | - | - | - | - | - | - | - | 4,6 | 59,5 | - | - | 3,6 | 57,0 | - | 86 |



| 165 t + 50 t | | 8,40 m | | 9.8 m/s | | 360° | | ISO | | | | | |
|--------------|-------|-----------|-------|---------|-------|-----------|-------|----------|-------|-----------|-------|-------|----|
| 90 m | | 93 m | | 12 m | | LSL+LF_2 | | LSL+LF_3 | | LSL+LF_6 | | | |
| 0 t | | 0 t-325 t | | 0 t | | 0 t-325 t | | 0 t | | 0 t-325 t | | | |
| 15° | | 20° | | 30° | | 15° | | 20° | | 15° | | 20° | |
| m | t | t | t | t | t | t | t | t | t | t | t | t | m |
| 14 | 145,0 | 172,0 | - | - | - | - | - | 155,0 | - | 137,0 | 157,0 | - | 14 |
| 15 | 136,5 | 169,5 | 130,0 | - | 134,0 | 147,0 | 123,0 | 151,0 | 117,0 | 128,5 | 152,5 | 117,0 | 15 |
| 16 | 128,0 | 167,0 | 127,0 | - | 126,0 | 145,0 | 121,0 | 147,0 | 114,0 | 120,0 | 148,0 | 115,0 | 16 |
| 17 | 120,5 | 162,5 | 124,5 | 80,5 | 119,0 | 143,0 | 118,5 | 143,5 | 111,5 | 113,0 | 144,5 | 112,5 | 17 |
| 18 | 113,0 | 158,0 | 122,0 | 79,5 | 112,0 | 141,0 | 116,0 | 140,0 | 109,0 | 106,0 | 141,0 | 110,0 | 18 |
| 20 | 101,0 | 150,0 | 117,0 | 77,0 | 100,0 | 137,0 | 112,0 | 133,0 | 105,0 | 94,5 | 134,0 | 106,0 | 20 |
| 22 | 91,5 | 143,0 | 113,0 | 75,0 | 91,0 | 132,0 | 108,0 | 127,0 | 101,0 | 85,2 | 128,5 | 102,0 | 22 |
| 24 | 83,0 | 137,0 | 108,0 | 73,0 | 82,0 | 127,0 | 104,0 | 121,0 | 97,5 | 76,0 | 123,0 | 98,0 | 24 |
| 26 | 75,5 | 131,0 | 104,0 | 71,0 | 75,0 | 122,0 | 100,0 | 116,0 | 94,0 | 69,2 | 118,0 | 95,0 | 26 |
| 28 | 69,0 | 126,0 | 101,0 | 69,0 | 68,0 | 117,0 | 97,0 | 111,0 | 90,5 | 62,5 | 113,0 | 91,5 | 28 |
| 30 | 63,0 | 121,0 | 98,0 | 67,5 | 62,5 | 113,0 | 94,0 | 107,0 | 87,5 | 57,2 | 109,0 | 88,5 | 30 |
| 34 | 53,9 | 112,3 | 92,0 | 64,5 | 52,9 | 105,0 | 88,3 | 99,7 | 82,5 | 47,7 | 101,2 | 83,5 | 34 |
| 38 | 45,8 | 104,8 | 86,6 | 61,6 | 45,3 | 98,0 | 83,3 | 93,5 | 77,8 | 40,1 | 94,5 | 78,8 | 38 |
| 42 | 38,8 | 98,5 | 82,0 | 59,0 | 38,3 | 92,0 | 79,0 | 87,5 | 73,5 | 33,5 | 88,5 | 74,5 | 42 |
| 46 | 32,5 | 92,8 | 78,0 | 57,0 | 32,1 | 87,6 | 75,6 | 82,5 | 69,8 | 27,7 | 83,8 | 70,8 | 46 |
| 50 | 27,0 | 87,6 | 74,3 | 55,0 | 26,6 | 83,3 | 72,3 | 78,0 | 66,5 | 22,4 | 79,5 | 67,5 | 50 |
| 54 | 22,3 | 83,0 | 71,0 | 53,0 | 22,0 | 79,0 | 69,0 | 74,0 | 63,5 | 17,7 | 75,5 | 64,5 | 54 |
| 58 | 18,6 | 79,3 | 68,3 | 51,6 | 18,3 | 75,3 | 66,3 | 70,6 | 61,1 | 14,0 | 71,8 | 62,1 | 58 |
| 62 | 15,3 | 75,8 | 65,8 | 50,4 | 15,0 | 72,0 | 63,8 | 67,5 | 59,0 | 10,7 | 68,6 | 59,8 | 62 |
| 66 | 12,4 | 72,5 | 63,5 | 49,2 | 12,2 | 69,0 | 61,5 | 64,5 | 57,0 | 7,8 | 66,0 | 57,5 | 66 |
| 70 | 10,0 | 69,8 | 61,5 | 48,1 | 9,8 | 66,3 | 59,5 | 62,1 | 55,0 | 5,4 | 63,3 | 55,9 | 70 |
| 73 | 8,3 | 67,9 | 60,0 | 47,4 | 8,1 | 64,4 | 58,0 | 60,5 | 53,7 | 3,7 | 61,5 | 54,5 | 73 |
| 74 | 7,8 | 67,3 | 59,6 | 47,2 | 7,6 | 63,8 | 57,6 | 60,0 | 53,5 | - | 61,0 | 54,1 | 74 |
| 78 | 5,8 | 65,0 | 58,0 | 46,5 | 5,7 | 61,5 | 56,0 | 58,0 | 52,0 | - | 59,0 | 52,5 | 78 |
| 82 | 4,2 | 63,0 | 56,6 | - | 4,0 | 60,0 | 54,8 | 56,3 | 50,6 | - | 57,3 | 51,1 | 82 |
| 83 | 3,8 | 62,5 | 56,3 | - | 3,6 | 59,5 | 54,5 | 55,9 | 50,3 | - | 56,9 | 50,8 | 83 |
| 86 | - | 61,3 | 55,5 | - | - | 58,3 | 53,5 | 54,8 | 49,7 | - | 55,8 | 50,1 | 86 |
| 88 | - | 60,6 | 55,0 | - | - | 57,6 | 53,0 | 54,1 | 49,5 | - | 55,1 | 49,8 | 88 |
| 90 | - | 60,0 | - | - | - | 57,0 | - | 53,5 | - | - | 54,5 | 49,5 | 90 |
| 91 | - | 59,5 | - | - | - | 57,0 | - | 53,5 | - | - | 54,1 | 45,8 | 91 |
| 94 | - | - | - | - | - | - | - | - | - | - | 53,0 | - | 94 |



| 165 t + 50 t | | 8,40 m | | 9.8 m/s | | 360° | | ISO | | | | | | | | | |
|--------------|-------|--------|----------|---------|-------|----------|-------|-----|----------|-------|-------|----------|-------|-------|-----------|-------|----|
| 96 m | | | | | | | | | | | | | | | | | |
| LSL+LF_2 | | | LSL+LF_3 | | | LSL+LF_4 | | | LSL+LF_6 | | | LSL+LF_8 | | | LSL+LF_10 | | |
| 12 m | | | | | | | | | | | | | | | | | |
| 0 t | | | 0t-325t | | | 0 t | | | 0t-325t | | | 0 t | | | 0t-325t | | |
| 15° | | 20° | | 30° | | 15° | | 20° | | 15° | | 20° | | 15° | | 20° | |
| m | t | t | t | t | t | t | t | t | t | t | t | t | t | t | t | t | m |
| 14 | 140,0 | 157,0 | - | - | - | - | - | - | - | 158,0 | - | 147,0 | 178,0 | - | 178,0 | - | 14 |
| 15 | 131,5 | 156,5 | 132,0 | - | 129,0 | 144,0 | 123,0 | - | - | 153,5 | 118,0 | 138,0 | 177,0 | - | 177,0 | - | 15 |
| 16 | 123,0 | 156,0 | 129,0 | - | 121,0 | 143,0 | 122,0 | - | - | 149,0 | 115,0 | 129,0 | 176,0 | 129,0 | 176,0 | 129,0 | 16 |
| 17 | 116,0 | 155,5 | 126,5 | 81,0 | 114,0 | 141,5 | 120,0 | - | - | 145,5 | 113,0 | 122,0 | 171,5 | 126,5 | 171,5 | 126,5 | 17 |
| 18 | 109,0 | 155,0 | 124,0 | 80,0 | 107,0 | 140,0 | 118,0 | - | - | 142,0 | 111,0 | 115,0 | 167,0 | 124,0 | 167,0 | 124,0 | 18 |
| 20 | 98,5 | 153,0 | 119,0 | 77,5 | 96,5 | 137,0 | 113,0 | - | - | 135,0 | 106,0 | 103,0 | 160,0 | 120,0 | 160,0 | 120,0 | 20 |
| 22 | 88,5 | 146,0 | 114,0 | 75,5 | 87,5 | 132,5 | 109,0 | - | - | 129,5 | 102,0 | 93,5 | 153,0 | 116,0 | 153,0 | 116,0 | 22 |
| 24 | 80,0 | 140,0 | 110,0 | 73,5 | 78,5 | 128,0 | 106,0 | - | - | 124,0 | 99,0 | 84,0 | 146,0 | 112,0 | 146,0 | 112,0 | 24 |
| 26 | 73,0 | 134,0 | 106,0 | 71,5 | 71,7 | 123,5 | 102,0 | - | - | 119,0 | 95,5 | 76,7 | 140,5 | 108,0 | 140,5 | 108,0 | 26 |
| 28 | 66,5 | 129,0 | 103,0 | 70,0 | 65,0 | 119,0 | 99,0 | - | - | 114,0 | 92,5 | 69,5 | 135,0 | 105,0 | 135,0 | 105,0 | 28 |
| 30 | 61,0 | 124,0 | 100,0 | 68,0 | 59,7 | 115,5 | 96,0 | - | - | 110,0 | 89,5 | 63,7 | 130,0 | 101,0 | 130,0 | 101,0 | 30 |
| 34 | 52,0 | 115,3 | 94,0 | 65,3 | 50,3 | 108,5 | 90,3 | - | - | 102,5 | 84,5 | 53,6 | 121,0 | 95,6 | 121,0 | 95,6 | 34 |
| 38 | 44,2 | 107,6 | 88,6 | 62,6 | 42,7 | 101,8 | 85,3 | - | - | 96,0 | 79,8 | 45,7 | 113,3 | 90,8 | 113,3 | 90,8 | 38 |
| 42 | 37,6 | 101,0 | 84,0 | 60,0 | 36,1 | 95,5 | 81,0 | - | - | 90,0 | 75,5 | 38,7 | 106,0 | 86,5 | 106,0 | 86,5 | 42 |
| 46 | 31,5 | 95,6 | 80,0 | 58,0 | 30,2 | 90,5 | 77,6 | - | - | 85,0 | 71,8 | 32,3 | 100,6 | 82,5 | 100,6 | 82,5 | 46 |
| 50 | 26,1 | 90,6 | 76,3 | 56,0 | 24,9 | 86,0 | 74,3 | - | - | 80,5 | 68,5 | 26,6 | 95,5 | 78,8 | 95,5 | 78,8 | 50 |
| 54 | 21,4 | 86,0 | 73,0 | 54,0 | 20,2 | 82,0 | 71,0 | - | - | 76,5 | 65,5 | 21,7 | 90,5 | 75,5 | 90,5 | 75,5 | 54 |
| 58 | 17,6 | 82,0 | 70,3 | 52,3 | 16,5 | 78,3 | 68,3 | - | - | 73,1 | 62,8 | 17,7 | 86,5 | 72,5 | 86,5 | 72,5 | 58 |
| 62 | 14,3 | 78,3 | 67,6 | 51,0 | 13,2 | 74,8 | 65,6 | - | - | 70,0 | 60,5 | 14,2 | 82,8 | 69,8 | 82,8 | 69,8 | 62 |
| 66 | 11,4 | 75,0 | 65,0 | 50,0 | 10,3 | 71,5 | 63,0 | - | - | 67,0 | 58,5 | 11,1 | 79,5 | 67,5 | 79,5 | 67,5 | 66 |
| 70 | 9,0 | 72,3 | 63,0 | 48,9 | 7,9 | 68,8 | 61,0 | - | - | 64,5 | 56,5 | 8,5 | 76,5 | 65,5 | 76,5 | 65,5 | 70 |
| 74 | 6,8 | 69,6 | 61,1 | 47,9 | 5,7 | 66,1 | 59,1 | - | - | 62,0 | 54,6 | 6,2 | 73,8 | 63,7 | 73,8 | 63,7 | 74 |
| 78 | 4,8 | 67,0 | 59,5 | 47,1 | 3,8 | 63,5 | 57,5 | - | - | 60,0 | 53,0 | 4,2 | 71,0 | 62,0 | 71,0 | 62,0 | 78 |
| 79 | 4,3 | 66,5 | 59,0 | 46,9 | - | 63,0 | 57,0 | - | - | 59,5 | 52,7 | 3,7 | 70,5 | 61,6 | 70,5 | 61,6 | 79 |
| 81 | 3,5 | 65,5 | 58,2 | 46,5 | - | 62,2 | 56,2 | - | - | 58,5 | 52,2 | - | 69,5 | 61,0 | 69,5 | 61,0 | 81 |
| 82 | - | 65,0 | 57,8 | 46,4 | - | 61,8 | 55,8 | - | - | 58,0 | 52,0 | - | 69,0 | 60,6 | 69,0 | 60,6 | 82 |
| 86 | - | 63,1 | 56,5 | - | - | 60,1 | 54,5 | - | - | 56,3 | 50,9 | - | 67,1 | 59,3 | 67,1 | 59,3 | 86 |
| 90 | - | 61,5 | 55,5 | - | - | 58,5 | 53,5 | - | - | 55,0 | 49,9 | - | 65,5 | 58,0 | 65,5 | 58,0 | 90 |
| 93 | - | 60,5 | 55,0 | - | - | 57,7 | 53,0 | - | - | 54,2 | 49,3 | - | 64,5 | 57,5 | 64,5 | 57,5 | 93 |
| 94 | - | 60,1 | - | - | - | 57,5 | - | - | - | 54,0 | - | - | 64,1 | - | 64,1 | - | 94 |
| 96 | - | 59,5 | - | - | - | 57,0 | - | - | - | 53,5 | - | - | 63,5 | - | 63,5 | - | 96 |



| 165 t + 50 t | | 8,40 m | | 9.8 m/s | | 360° | | ISO | | | | | | | | | | | | | | | |
|--------------|---|--------|---|-----------|---|------|---|----------|---|-------|-------|-----------|-------|-------|-------|----------|-------|-----|---|-----------|--|--|--|
| 99 m | | | | | | | | | | | | | | | | | | | | | | | |
| LSL+LF_2 | | | | LSL+LF_3 | | | | LSL+LF_4 | | | | LSL+LF_6 | | | | LSL+LF_8 | | | | LSL+LF_10 | | | |
| 12 m | | | | | | | | | | | | | | | | | | | | | | | |
| 0 t | | | | 0 t-325 t | | | | 0 t | | | | 0 t-325 t | | | | 0 t | | | | 0 t-325 t | | | |
| 15° | | 20° | | 30° | | 15° | | 20° | | 15° | | 20° | | 15° | | 20° | | 15° | | 20° | | | |
| m | t | t | t | t | t | t | t | t | t | t | t | t | t | t | t | t | t | t | t | m | | | |
| 15 | - | - | - | - | - | - | - | - | - | 122,0 | 154,0 | - | 135,0 | 178,0 | - | 178,0 | - | - | - | 15 | | | |
| 16 | - | - | - | - | - | - | - | - | - | 114,0 | 151,0 | 116,0 | 126,0 | 177,0 | 130,0 | 177,0 | 130,0 | - | - | 16 | | | |
| 18 | - | - | - | - | - | - | - | - | - | 101,0 | 143,0 | 111,0 | 112,0 | 169,0 | 125,0 | 169,0 | 125,0 | - | - | 18 | | | |
| 20 | - | - | - | - | - | - | - | - | - | 90,0 | 137,0 | 107,0 | 100,0 | 161,0 | 121,0 | 161,0 | 121,0 | - | - | 20 | | | |
| 22 | - | - | - | - | - | - | - | - | - | 81,2 | 131,0 | 103,0 | 90,7 | 154,5 | 116,0 | 154,5 | 116,0 | - | - | 22 | | | |
| 24 | - | - | - | - | - | - | - | - | - | 72,5 | 125,0 | 100,0 | 81,5 | 148,0 | 112,0 | 148,0 | 112,0 | - | - | 24 | | | |
| 26 | - | - | - | - | - | - | - | - | - | 66,0 | 120,5 | 96,5 | 74,5 | 142,0 | 109,0 | 142,0 | 109,0 | - | - | 26 | | | |
| 28 | - | - | - | - | - | - | - | - | - | 59,5 | 116,0 | 93,5 | 67,5 | 136,0 | 105,0 | 136,0 | 105,0 | - | - | 28 | | | |
| 30 | - | - | - | - | - | - | - | - | - | 54,3 | 111,5 | 90,5 | 62,0 | 131,5 | 102,0 | 131,5 | 102,0 | - | - | 30 | | | |
| 34 | - | - | - | - | - | - | - | - | - | 44,9 | 103,5 | 85,1 | 52,1 | 122,5 | 96,6 | 122,5 | 96,6 | - | - | 34 | | | |
| 38 | - | - | - | - | - | - | - | - | - | 37,4 | 97,1 | 80,3 | 44,2 | 114,6 | 91,6 | 114,6 | 91,6 | - | - | 38 | | | |
| 42 | - | - | - | - | - | - | - | - | - | 30,9 | 91,5 | 76,0 | 37,2 | 108,0 | 87,0 | 108,0 | 87,0 | - | - | 42 | | | |
| 46 | - | - | - | - | - | - | - | - | - | 25,6 | 86,5 | 72,6 | 31,1 | 102,3 | 83,3 | 102,3 | 83,3 | - | - | 46 | | | |
| 50 | - | - | - | - | - | - | - | - | - | 20,6 | 81,8 | 69,5 | 25,6 | 97,0 | 79,8 | 97,0 | 79,8 | - | - | 50 | | | |
| 54 | - | - | - | - | - | - | - | - | - | 15,9 | 77,5 | 66,5 | 20,6 | 92,0 | 76,5 | 92,0 | 76,5 | - | - | 54 | | | |
| 58 | - | - | - | - | - | - | - | - | - | 12,2 | 74,1 | 63,8 | 16,6 | 88,0 | 73,5 | 88,0 | 73,5 | - | - | 58 | | | |
| 62 | - | - | - | - | - | - | - | - | - | 8,9 | 71,0 | 61,3 | 13,1 | 84,1 | 70,8 | 84,1 | 70,8 | - | - | 62 | | | |
| 66 | - | - | - | - | - | - | - | - | - | 5,9 | 68,0 | 59,0 | 10,0 | 80,5 | 68,5 | 80,5 | 68,5 | - | - | 66 | | | |
| 69 | - | - | - | - | - | - | - | - | - | 4,0 | 66,1 | 57,7 | 8,1 | 78,2 | 67,0 | 78,2 | 67,0 | - | - | 69 | | | |
| 70 | - | - | - | - | - | - | - | - | - | - | 65,4 | 57,3 | 7,4 | 77,5 | 66,5 | 77,5 | 66,5 | - | - | 70 | | | |
| 74 | - | - | - | - | - | - | - | - | - | - | 63,0 | 55,6 | 5,1 | 74,8 | 64,5 | 75,0 | 64,5 | - | - | 74 | | | |
| 77 | - | - | - | - | - | - | - | - | - | - | 61,5 | 54,4 | 3,5 | 73,0 | 63,0 | 73,1 | 63,0 | - | - | 77 | | | |
| 78 | - | - | - | - | - | - | - | - | - | - | 61,0 | 54,0 | - | 72,5 | 62,5 | 72,5 | 62,5 | - | - | 78 | | | |
| 82 | - | - | - | - | - | - | - | - | - | - | 59,0 | 52,6 | - | 70,1 | 61,1 | 70,1 | 61,1 | - | - | 82 | | | |
| 86 | - | - | - | - | - | - | - | - | - | - | 57,1 | 51,3 | - | 68,1 | 59,8 | 68,1 | 59,8 | - | - | 86 | | | |
| 90 | - | - | - | - | - | - | - | - | - | - | 55,5 | 50,0 | - | 66,5 | 58,5 | 66,5 | 58,5 | - | - | 90 | | | |
| 94 | - | - | - | - | - | - | - | - | - | - | 54,5 | 49,5 | - | 64,8 | 57,8 | 64,8 | 57,8 | - | - | 94 | | | |
| 96 | - | - | - | - | - | - | - | - | - | - | 54,0 | 49,2 | - | 64,0 | 57,5 | 64,0 | 57,5 | - | - | 96 | | | |
| 98 | - | - | - | - | - | - | - | - | - | - | 53,3 | - | - | 62,6 | - | 62,0 | - | - | - | 98 | | | |
| 99 | - | - | - | - | - | - | - | - | - | - | 53,0 | - | - | 62,0 | - | 61,0 | - | - | - | 99 | | | |



| 165 t + 50 t | | 8,40 m | | 9.8 m/s | | 360° | | ISO | | | | | | | | | |
|--------------|-------|---------|----------|---------|-------|----------|---------|-------|----------|-------|-------|----------|-------|-------|-----------|-------|-----|
| 102 m | | | | | | | | | | | | | | | | | |
| LSL+LF_2 | | | LSL+LF_3 | | | LSL+LF_4 | | | LSL+LF_6 | | | LSL+LF_8 | | | LSL+LF_10 | | |
| 12 m | | | | | | | | | | | | | | | | | |
| 0 t | | 0t-325t | | | 0 t | | 0t-325t | | | 0 t | | 0t-325t | | | | | |
| 15° | | 20° | | 30° | | 15° | | 20° | | 15° | | 20° | | 15° | | 20° | |
| m | t | t | t | t | t | t | t | t | t | t | t | t | t | t | t | t | m |
| 15 | 126,0 | 147,0 | - | - | - | - | - | 143,0 | - | 155,0 | - | 132,0 | 178,0 | - | 178,0 | - | 15 |
| 16 | 118,0 | 147,0 | 130,0 | - | 116,0 | 139,0 | 120,0 | 141,0 | 124,0 | 152,0 | 117,0 | 124,0 | 178,0 | 131,0 | 178,0 | 131,0 | 16 |
| 18 | 105,0 | 146,0 | 125,0 | 80,5 | 103,0 | 137,0 | 118,0 | 139,0 | 122,0 | 144,0 | 112,0 | 110,0 | 170,0 | 126,0 | 170,0 | 126,0 | 18 |
| 20 | 94,0 | 145,0 | 120,0 | 78,0 | 92,5 | 134,0 | 114,0 | 137,0 | 119,0 | 138,0 | 108,0 | 98,5 | 162,0 | 121,0 | 162,0 | 121,0 | 20 |
| 22 | 85,0 | 144,0 | 116,0 | 76,0 | 83,7 | 131,0 | 110,0 | 133,5 | 115,0 | 132,0 | 104,0 | 89,2 | 155,5 | 117,0 | 155,5 | 117,0 | 22 |
| 24 | 76,5 | 141,0 | 112,0 | 74,0 | 75,0 | 128,0 | 107,0 | 130,0 | 111,0 | 126,0 | 100,0 | 80,0 | 149,0 | 113,0 | 149,0 | 113,0 | 24 |
| 26 | 69,5 | 137,0 | 108,0 | 72,5 | 68,5 | 124,5 | 104,0 | 126,0 | 107,0 | 121,5 | 97,0 | 72,7 | 143,5 | 110,0 | 143,5 | 110,0 | 26 |
| 28 | 63,5 | 132,0 | 105,0 | 70,5 | 62,0 | 121,0 | 101,0 | 122,0 | 104,0 | 117,0 | 94,0 | 65,5 | 138,0 | 106,0 | 138,0 | 106,0 | 28 |
| 30 | 58,0 | 127,0 | 102,0 | 69,0 | 56,7 | 117,5 | 98,0 | 118,5 | 101,0 | 113,0 | 91,0 | 60,2 | 133,0 | 103,0 | 133,0 | 103,0 | 30 |
| 34 | 49,2 | 118,3 | 96,0 | 66,0 | 47,5 | 111,0 | 92,3 | 111,5 | 95,6 | 105,0 | 86,0 | 50,5 | 124,0 | 97,6 | 124,0 | 97,6 | 34 |
| 38 | 41,6 | 110,6 | 90,6 | 63,3 | 40,3 | 105,1 | 87,3 | 105,0 | 90,6 | 98,1 | 81,3 | 42,6 | 116,3 | 92,6 | 116,3 | 92,6 | 38 |
| 42 | 35,1 | 104,0 | 86,0 | 61,0 | 33,8 | 99,5 | 83,0 | 99,0 | 86,0 | 92,5 | 77,0 | 35,7 | 109,0 | 88,0 | 109,0 | 88,0 | 42 |
| 46 | 29,5 | 98,6 | 82,0 | 58,6 | 28,4 | 93,8 | 79,3 | 93,6 | 82,0 | 87,5 | 73,3 | 29,9 | 103,6 | 84,3 | 103,6 | 84,3 | 46 |
| 50 | 24,4 | 93,5 | 78,3 | 56,6 | 23,3 | 88,6 | 76,0 | 88,8 | 78,1 | 83,0 | 70,0 | 24,5 | 98,5 | 80,8 | 98,5 | 80,8 | 50 |
| 54 | 19,6 | 88,5 | 75,0 | 55,0 | 18,6 | 84,0 | 73,0 | 84,5 | 74,5 | 79,0 | 67,0 | 19,5 | 93,5 | 77,5 | 93,5 | 77,5 | 54 |
| 58 | 15,9 | 84,5 | 72,0 | 53,3 | 14,9 | 80,6 | 70,3 | 80,8 | 71,5 | 75,3 | 64,3 | 15,5 | 89,5 | 74,5 | 89,5 | 74,5 | 58 |
| 62 | 12,6 | 80,8 | 69,3 | 51,8 | 11,6 | 77,3 | 67,6 | 77,3 | 68,8 | 72,0 | 62,0 | 12,0 | 85,6 | 71,8 | 85,6 | 71,8 | 62 |
| 66 | 9,6 | 77,5 | 67,0 | 50,5 | 8,7 | 74,0 | 65,0 | 74,0 | 66,5 | 69,0 | 60,0 | 8,9 | 82,0 | 69,5 | 82,0 | 69,5 | 66 |
| 70 | 7,2 | 74,5 | 64,6 | 49,5 | 6,3 | 71,0 | 63,0 | 71,3 | 64,5 | 66,4 | 58,0 | 6,3 | 79,0 | 67,1 | 79,0 | 67,1 | 70 |
| 74 | 4,9 | 71,7 | 62,7 | 48,6 | 4,0 | 68,5 | 61,0 | 68,6 | 62,5 | 64,0 | 56,1 | 4,0 | 76,0 | 65,1 | 75,9 | 65,1 | 74 |
| 75 | 4,4 | 71,1 | 62,3 | 48,4 | 3,5 | 68,0 | 60,5 | 68,0 | 62,0 | 63,5 | 55,7 | - | 75,3 | 64,7 | 75,3 | 64,7 | 75 |
| 76 | 3,9 | 70,5 | 61,9 | 48,1 | - | 67,3 | 60,0 | 67,3 | 61,5 | 63,0 | 55,3 | - | 74,7 | 64,3 | 74,7 | 64,3 | 76 |
| 78 | - | 69,5 | 61,0 | 47,7 | - | 66,0 | 59,0 | 66,0 | 60,5 | 62,0 | 54,5 | - | 73,5 | 63,5 | 73,5 | 63,5 | 78 |
| 82 | - | 67,1 | 59,3 | 46,9 | - | 64,0 | 57,6 | 64,0 | 58,8 | 60,0 | 53,1 | - | 71,1 | 61,8 | 71,1 | 61,8 | 82 |
| 86 | - | 65,1 | 57,8 | 46,3 | - | 62,1 | 56,3 | 62,1 | 57,3 | 58,1 | 51,8 | - | 69,0 | 60,3 | 69,0 | 60,3 | 86 |
| 87 | - | 64,7 | 57,5 | 46,1 | - | 61,7 | 56,0 | 61,7 | 57,0 | 57,7 | 51,5 | - | 68,5 | 60,0 | 68,5 | 60,0 | 87 |
| 90 | - | 63,5 | 56,5 | - | - | 60,5 | 55,0 | 60,5 | 56,0 | 56,5 | 50,5 | - | 67,0 | 59,0 | 67,0 | 59,0 | 90 |
| 94 | - | 60,8 | 55,5 | - | - | 58,8 | 54,0 | 58,8 | 55,0 | 55,1 | 49,9 | - | 64,6 | 58,0 | 64,3 | 58,0 | 94 |
| 98 | - | 57,8 | 54,5 | - | - | 56,6 | 53,0 | 56,3 | 54,0 | 53,5 | 49,2 | - | 61,6 | 57,5 | 61,1 | 57,5 | 98 |
| 99 | - | 57,0 | 35,6 | - | - | 56,0 | - | 55,5 | 22,3 | 53,0 | - | - | 60,7 | - | 60,2 | - | 99 |
| 102 | - | 54,5 | - | - | - | 54,0 | - | 53,0 | - | 50,5 | - | - | 58,0 | - | 57,5 | - | 102 |



| 165 t + 50 t | | 8,40 m | | 9.8 m/s | | 360° | | ISO | | | | | | | | | | | | | | | | | | | |
|--------------|---|--------|---|-----------|---|------|---|----------|-------|-------|-------|-----------|-------|-------|-------|----------|-------|-------|-----|-----------|--|--|--|-----|--|--|--|
| 105 m | | | | | | | | | | | | | | | | | | | | | | | | | | | |
| LSL+LF_2 | | | | LSL+LF_3 | | | | LSL+LF_4 | | | | LSL+LF_6 | | | | LSL+LF_8 | | | | LSL+LF_10 | | | | | | | |
| 12 m | | | | | | | | | | | | | | | | | | | | | | | | | | | |
| 0 t | | | | 0 t-325 t | | | | 0 t | | | | 0 t-325 t | | | | 0 t | | | | 0 t-325 t | | | | | | | |
| 15° | | | | 20° | | | | 30° | | | | 15° | | | | 20° | | | | 15° | | | | 20° | | | |
| m | t | t | t | t | t | t | t | t | t | t | t | t | t | t | t | t | t | t | t | m | | | | | | | |
| 15 | - | - | - | - | - | - | - | 119,0 | 136,0 | - | 152,0 | - | 129,0 | 176,0 | - | 178,0 | - | - | 15 | | | | | | | | |
| 16 | - | - | - | - | - | - | - | 112,0 | 135,0 | 123,0 | 152,0 | 117,0 | 121,0 | 176,0 | 131,0 | 178,0 | 131,0 | - | 16 | | | | | | | | |
| 18 | - | - | - | - | - | - | - | 99,5 | 132,0 | 121,0 | 146,0 | 113,0 | 107,0 | 171,0 | 126,0 | 171,0 | 126,0 | 171,0 | 18 | | | | | | | | |
| 20 | - | - | - | - | - | - | - | 89,0 | 130,0 | 119,0 | 139,0 | 108,0 | 96,0 | 164,0 | 122,0 | 164,0 | 122,0 | 164,0 | 20 | | | | | | | | |
| 22 | - | - | - | - | - | - | - | 80,2 | 127,5 | 115,0 | 133,5 | 105,0 | 86,7 | 157,5 | 118,0 | 157,5 | 118,0 | 118,0 | 22 | | | | | | | | |
| 24 | - | - | - | - | - | - | - | 71,5 | 125,0 | 111,0 | 128,0 | 101,0 | 77,5 | 151,0 | 114,0 | 151,0 | 114,0 | 114,0 | 24 | | | | | | | | |
| 26 | - | - | - | - | - | - | - | 65,2 | 122,0 | 108,0 | 123,0 | 98,0 | 70,7 | 145,0 | 110,0 | 145,0 | 110,0 | 110,0 | 26 | | | | | | | | |
| 28 | - | - | - | - | - | - | - | 59,0 | 119,0 | 105,0 | 118,0 | 95,0 | 64,0 | 139,0 | 107,0 | 139,0 | 107,0 | 107,0 | 28 | | | | | | | | |
| 30 | - | - | - | - | - | - | - | 53,9 | 116,5 | 101,0 | 114,0 | 92,0 | 58,5 | 134,5 | 104,0 | 134,5 | 104,0 | 104,0 | 30 | | | | | | | | |
| 34 | - | - | - | - | - | - | - | 44,8 | 111,5 | 96,0 | 106,5 | 87,0 | 48,7 | 125,5 | 98,6 | 125,5 | 98,6 | 98,6 | 34 | | | | | | | | |
| 38 | - | - | - | - | - | - | - | 37,5 | 106,0 | 91,3 | 100,0 | 82,3 | 41,0 | 117,6 | 93,6 | 117,6 | 93,6 | 93,6 | 38 | | | | | | | | |
| 42 | - | - | - | - | - | - | - | 31,1 | 100,0 | 87,0 | 94,0 | 78,0 | 34,2 | 111,0 | 89,0 | 111,0 | 89,0 | 89,0 | 42 | | | | | | | | |
| 46 | - | - | - | - | - | - | - | 26,1 | 94,6 | 83,0 | 89,0 | 74,3 | 28,6 | 105,0 | 85,0 | 105,0 | 85,0 | 85,0 | 46 | | | | | | | | |
| 50 | - | - | - | - | - | - | - | 21,2 | 89,1 | 79,1 | 84,3 | 71,0 | 23,4 | 99,6 | 81,3 | 99,6 | 81,3 | 81,3 | 50 | | | | | | | | |
| 54 | - | - | - | - | - | - | - | 16,6 | 83,5 | 75,5 | 80,0 | 68,0 | 18,4 | 95,0 | 78,0 | 95,0 | 78,0 | 78,0 | 54 | | | | | | | | |
| 58 | - | - | - | - | - | - | - | 12,8 | 80,1 | 72,5 | 76,3 | 65,3 | 14,4 | 90,6 | 75,3 | 90,6 | 75,3 | 75,3 | 58 | | | | | | | | |
| 62 | - | - | - | - | - | - | - | 9,5 | 76,8 | 69,6 | 73,0 | 62,8 | 10,9 | 86,6 | 72,6 | 86,6 | 72,6 | 72,6 | 62 | | | | | | | | |
| 66 | - | - | - | - | - | - | - | 6,6 | 73,5 | 67,0 | 70,0 | 60,5 | 7,8 | 83,0 | 70,0 | 83,0 | 70,0 | 70,0 | 66 | | | | | | | | |
| 70 | - | - | - | - | - | - | - | 4,2 | 70,7 | 65,0 | 67,3 | 58,5 | 5,2 | 80,2 | 68,0 | 80,2 | 68,0 | 68,0 | 70 | | | | | | | | |
| 71 | - | - | - | - | - | - | - | 3,6 | 70,0 | 64,5 | 66,6 | 58,0 | 4,5 | 79,5 | 67,5 | 79,5 | 67,5 | 67,5 | 71 | | | | | | | | |
| 72 | - | - | - | - | - | - | - | - | 69,5 | 64,0 | 66,0 | 57,5 | 3,9 | 78,5 | 67,0 | 78,5 | 67,0 | 67,0 | 72 | | | | | | | | |
| 74 | - | - | - | - | - | - | - | - | 68,1 | 63,1 | 64,8 | 56,6 | - | 77,1 | 66,0 | 77,1 | 66,0 | 66,0 | 74 | | | | | | | | |
| 78 | - | - | - | - | - | - | - | - | 65,5 | 61,5 | 62,5 | 55,0 | - | 74,5 | 64,0 | 74,5 | 64,0 | 64,0 | 78 | | | | | | | | |
| 82 | - | - | - | - | - | - | - | - | 63,1 | 59,3 | 60,5 | 53,6 | - | 72,1 | 62,3 | 72,1 | 62,3 | 62,3 | 82 | | | | | | | | |
| 86 | - | - | - | - | - | - | - | - | 61,1 | 57,8 | 58,8 | 52,3 | - | 70,0 | 61,0 | 70,0 | 61,0 | 61,0 | 86 | | | | | | | | |
| 90 | - | - | - | - | - | - | - | - | 59,5 | 56,5 | 57,5 | 51,0 | - | 68,0 | 60,0 | 68,0 | 60,0 | 60,0 | 90 | | | | | | | | |
| 94 | - | - | - | - | - | - | - | - | 57,8 | 55,5 | 55,8 | 50,3 | - | 64,3 | 58,6 | 64,0 | 58,6 | 58,6 | 94 | | | | | | | | |
| 98 | - | - | - | - | - | - | - | - | 55,3 | 54,2 | 53,2 | 49,6 | - | 60,6 | 57,6 | 60,1 | 57,6 | 57,6 | 98 | | | | | | | | |
| 101 | - | - | - | - | - | - | - | - | 52,8 | 47,9 | 50,6 | 49,1 | - | 57,9 | 57,0 | 57,4 | 57,0 | 57,0 | 101 | | | | | | | | |
| 102 | - | - | - | - | - | - | - | - | 52,0 | - | 49,8 | - | - | 57,0 | - | 56,5 | - | - | 102 | | | | | | | | |
| 104 | - | - | - | - | - | - | - | - | 50,5 | - | 48,2 | - | - | 55,5 | - | 55,0 | - | - | 104 | | | | | | | | |



| 165 t + 50 t | | 8,40 m | | 9.8 m/s | | 360° | | ISO | | | | | | | | | |
|--------------|-------|--------|-----------|---------|-------|----------|-------|-------|-----------|-------|-------|----------|-------|-------|-----------|-------|-----|
| 108 m | | | | | | | | | | | | | | | | | |
| LSL+LF_2 | | | LSL+LF_3 | | | LSL+LF_4 | | | LSL+LF_6 | | | LSL+LF_8 | | | LSL+LF_10 | | |
| 12 m | | | | | | | | | | | | | | | | | |
| 0 t | | | 0 t-325 t | | | 0 t | | | 0 t-325 t | | | 0 t | | | 0 t-325 t | | |
| 15° | | 20° | | 30° | | 15° | | 20° | | 15° | | 20° | | 15° | | 20° | |
| m | t | t | t | t | t | t | t | t | t | t | t | t | t | t | t | t | m |
| 15 | 120,0 | 138,0 | - | - | - | - | - | 141,0 | - | 149,0 | - | 126,0 | 171,0 | - | 177,0 | - | 15 |
| 16 | 113,0 | 138,0 | 128,0 | - | 111,0 | 138,0 | 117,0 | 140,0 | 121,0 | 148,0 | 118,0 | 119,0 | 171,0 | - | 177,0 | - | 16 |
| 17 | 106,5 | 138,0 | 127,0 | - | 105,0 | 137,5 | 116,5 | 139,5 | 120,5 | 147,5 | 115,5 | 112,0 | 170,5 | 129,0 | 175,0 | 129,0 | 17 |
| 18 | 100,0 | 138,0 | 126,0 | 81,0 | 99,0 | 137,0 | 116,0 | 139,0 | 120,0 | 147,0 | 113,0 | 105,0 | 170,0 | 127,0 | 173,0 | 127,0 | 18 |
| 20 | 90,0 | 137,0 | 122,0 | 78,5 | 88,5 | 136,0 | 114,0 | 138,0 | 118,0 | 140,0 | 109,0 | 94,0 | 165,0 | 123,0 | 165,0 | 123,0 | 20 |
| 22 | 81,0 | 137,0 | 118,0 | 76,5 | 80,0 | 134,0 | 111,0 | 136,0 | 115,0 | 134,5 | 105,0 | 85,0 | 158,5 | 119,0 | 158,5 | 119,0 | 22 |
| 24 | 73,0 | 136,0 | 114,0 | 75,0 | 71,5 | 132,0 | 108,0 | 134,0 | 112,0 | 129,0 | 102,0 | 76,0 | 152,0 | 115,0 | 152,0 | 115,0 | 24 |
| 26 | 66,0 | 135,0 | 110,0 | 73,0 | 65,2 | 129,0 | 105,0 | 130,5 | 109,0 | 124,0 | 98,5 | 69,2 | 146,5 | 111,0 | 146,5 | 111,0 | 26 |
| 28 | 60,0 | 133,0 | 107,0 | 71,5 | 59,0 | 126,0 | 102,0 | 127,0 | 106,0 | 119,0 | 95,5 | 62,5 | 141,0 | 108,0 | 141,0 | 108,0 | 28 |
| 30 | 54,5 | 130,0 | 103,0 | 69,5 | 54,0 | 123,5 | 99,5 | 124,0 | 103,0 | 115,0 | 93,0 | 57,2 | 136,0 | 105,0 | 136,0 | 105,0 | 30 |
| 34 | 46,1 | 121,3 | 97,6 | 66,8 | 44,9 | 118,0 | 94,1 | 118,0 | 97,6 | 107,5 | 87,6 | 47,6 | 127,0 | 99,6 | 127,0 | 99,6 | 34 |
| 38 | 38,6 | 113,6 | 92,6 | 64,1 | 37,7 | 112,0 | 89,3 | 112,3 | 92,6 | 101,0 | 82,8 | 39,9 | 119,3 | 94,6 | 119,3 | 94,6 | 38 |
| 42 | 32,2 | 107,0 | 88,0 | 61,5 | 31,3 | 106,0 | 85,0 | 107,0 | 88,0 | 95,0 | 78,5 | 33,1 | 112,0 | 90,0 | 112,0 | 90,0 | 42 |
| 46 | 27,2 | 101,3 | 84,0 | 59,5 | 26,3 | 100,6 | 81,3 | 101,3 | 84,0 | 90,0 | 75,1 | 27,7 | 106,0 | 86,0 | 106,0 | 86,0 | 46 |
| 50 | 22,3 | 96,1 | 80,1 | 57,6 | 21,4 | 95,1 | 78,0 | 95,5 | 80,1 | 85,3 | 71,8 | 22,6 | 100,6 | 82,3 | 100,6 | 82,3 | 50 |
| 54 | 17,6 | 91,5 | 76,5 | 56,0 | 16,8 | 89,5 | 75,0 | 89,5 | 76,5 | 81,0 | 68,5 | 17,7 | 96,0 | 79,0 | 96,0 | 79,0 | 54 |
| 58 | 13,8 | 87,1 | 73,8 | 54,3 | 13,1 | 85,5 | 72,0 | 85,8 | 73,5 | 77,3 | 65,8 | 13,7 | 92,0 | 76,0 | 92,0 | 76,0 | 58 |
| 62 | 10,5 | 83,3 | 71,1 | 52,8 | 9,8 | 81,8 | 69,3 | 82,1 | 70,6 | 74,1 | 63,5 | 10,2 | 88,1 | 73,3 | 88,1 | 73,3 | 62 |
| 66 | 7,5 | 80,0 | 68,5 | 51,5 | 6,8 | 78,5 | 67,0 | 78,5 | 68,0 | 71,0 | 61,5 | 7,1 | 84,5 | 71,0 | 84,5 | 71,0 | 66 |
| 70 | 5,0 | 77,0 | 66,1 | 50,3 | 4,4 | 75,7 | 64,6 | 75,6 | 66,0 | 68,3 | 59,5 | 4,4 | 81,3 | 68,6 | 81,1 | 68,6 | 70 |
| 71 | 4,4 | 76,2 | 65,5 | 50,0 | 3,8 | 75,0 | 64,0 | 74,8 | 65,5 | 67,6 | 59,0 | 3,8 | 80,5 | 68,0 | 80,3 | 68,0 | 71 |
| 72 | 3,8 | 75,5 | 65,0 | 49,8 | - | 74,0 | 63,5 | 74,0 | 65,0 | 67,0 | 58,5 | - | 79,5 | 67,5 | 79,5 | 67,5 | 72 |
| 74 | - | 74,1 | 64,1 | 49,3 | - | 72,6 | 62,6 | 72,6 | 64,1 | 65,8 | 57,6 | - | 78,1 | 66,6 | 78,1 | 66,6 | 74 |
| 78 | - | 71,5 | 62,5 | 48,3 | - | 70,0 | 61,0 | 70,0 | 62,5 | 63,5 | 56,0 | - | 75,5 | 65,0 | 75,5 | 65,0 | 78 |
| 82 | - | 69,1 | 60,8 | 47,5 | - | 67,6 | 58,8 | 67,6 | 60,8 | 61,5 | 54,3 | - | 73,1 | 63,3 | 73,1 | 63,3 | 82 |
| 86 | - | 66,5 | 59,3 | 46,7 | - | 65,3 | 57,3 | 65,0 | 59,1 | 59,6 | 52,8 | - | 70,8 | 61,8 | 70,6 | 61,8 | 86 |
| 90 | - | 63,5 | 58,0 | 46,1 | - | 63,0 | 56,0 | 62,0 | 57,5 | 58,0 | 51,5 | - | 68,5 | 60,5 | 68,0 | 60,5 | 90 |
| 91 | - | 62,5 | 57,6 | 46,0 | - | 62,0 | 55,7 | 61,0 | 57,2 | 57,5 | 51,5 | - | 67,4 | 60,1 | 66,9 | 60,1 | 91 |
| 94 | - | 59,5 | 56,6 | - | - | 59,0 | 55,0 | 58,3 | 56,5 | 56,0 | 50,7 | - | 64,1 | 59,1 | 63,6 | 59,1 | 94 |
| 98 | - | 55,8 | 54,8 | - | - | 55,3 | 53,6 | 54,7 | 54,4 | 52,3 | 49,6 | - | 60,1 | 57,8 | 59,6 | 57,6 | 98 |
| 102 | - | 52,5 | 52,5 | - | - | 52,0 | 52,0 | 51,0 | 51,0 | 48,9 | 49,0 | - | 56,5 | 56,5 | 56,0 | 56,0 | 102 |
| 103 | - | 51,8 | 52,0 | - | - | 51,2 | 51,5 | 50,3 | 50,5 | 48,1 | 48,2 | - | 55,5 | 55,5 | 55,0 | 55,0 | 103 |
| 104 | - | 51,1 | 35,5 | - | - | 50,5 | - | 49,6 | 28,1 | 47,3 | - | - | 54,5 | - | 54,2 | - | 104 |
| 106 | - | 49,7 | - | - | - | 49,1 | - | 48,2 | - | 45,7 | - | - | 53,1 | - | 52,7 | - | 106 |
| 107 | - | 48,9 | - | - | - | 48,5 | - | 47,5 | - | 44,9 | - | - | 52,5 | - | 52,0 | - | 107 |



| 165 t + 50 t | | 8,40 m | | 9.8 m/s | | 360° | | ISO | | | | | | | | | | | | | | | |
|--------------|---|--------|---------|----------|-------|-------|-------|----------|---------|-------|-------|----------|-------|-------|---------|----------|-----|--|--|-----------|--|--|--|
| 111 m | | | | | | | | | | | | | | | | | | | | | | | |
| LSL+LF_2 | | | | LSL+LF_3 | | | | LSL+LF_4 | | | | LSL+LF_6 | | | | LSL+LF_8 | | | | LSL+LF_10 | | | |
| 12 m | | | | | | | | | | | | | | | | | | | | | | | |
| 0 t | | | 0t-325t | | | 0 t | | | 0t-325t | | | 0 t | | | 0t-325t | | | | | | | | |
| 15° | | 20° | | 30° | | 15° | | 20° | | 15° | | 20° | | 15° | | 20° | | | | | | | |
| m | t | t | t | t | t | t | t | t | t | t | t | t | t | t | t | t | m | | | | | | |
| 16 | - | - | - | - | - | - | - | 131,0 | - | 146,0 | - | 116,0 | 166,0 | - | 172,0 | - | 16 | | | | | | |
| 17 | - | - | - | - | 102,0 | 135,0 | 115,0 | 130,5 | 119,0 | 146,0 | 116,0 | 109,5 | 166,0 | 130,0 | 172,0 | 130,0 | 17 | | | | | | |
| 18 | - | - | - | - | 96,5 | 135,0 | 115,0 | 130,0 | 118,0 | 146,0 | 114,0 | 103,0 | 166,0 | 127,0 | 172,0 | 127,0 | 18 | | | | | | |
| 20 | - | - | - | - | 86,0 | 134,0 | 113,0 | 129,0 | 118,0 | 141,0 | 110,0 | 92,0 | 165,0 | 123,0 | 166,0 | 123,0 | 20 | | | | | | |
| 22 | - | - | - | - | 77,7 | 133,0 | 112,0 | 127,5 | 115,0 | 135,5 | 106,0 | 83,0 | 159,0 | 119,0 | 159,5 | 119,0 | 22 | | | | | | |
| 24 | - | - | - | - | 69,5 | 132,0 | 109,0 | 126,0 | 112,0 | 130,0 | 102,0 | 74,0 | 153,0 | 115,0 | 153,0 | 115,0 | 24 | | | | | | |
| 26 | - | - | - | - | 63,2 | 129,5 | 106,0 | 123,5 | 110,0 | 125,0 | 99,5 | 67,2 | 147,5 | 112,0 | 147,5 | 112,0 | 26 | | | | | | |
| 28 | - | - | - | - | 57,0 | 127,0 | 103,0 | 121,0 | 107,0 | 120,0 | 96,5 | 60,5 | 142,0 | 109,0 | 142,0 | 109,0 | 28 | | | | | | |
| 30 | - | - | - | - | 52,1 | 124,0 | 100,0 | 118,0 | 104,0 | 116,0 | 93,5 | 55,2 | 137,5 | 106,0 | 137,5 | 106,0 | 30 | | | | | | |
| 34 | - | - | - | - | 43,3 | 118,5 | 95,3 | 113,5 | 98,3 | 108,5 | 88,5 | 45,8 | 128,5 | 100,3 | 128,5 | 100,3 | 34 | | | | | | |
| 38 | - | - | - | - | 36,1 | 113,3 | 90,6 | 108,3 | 93,3 | 102,0 | 83,8 | 38,3 | 120,6 | 95,3 | 120,6 | 95,3 | 38 | | | | | | |
| 42 | - | - | - | - | 29,8 | 108,0 | 86,0 | 103,0 | 89,0 | 96,0 | 79,5 | 31,5 | 114,0 | 91,0 | 114,0 | 91,0 | 42 | | | | | | |
| 46 | - | - | - | - | 24,8 | 102,6 | 82,3 | 97,6 | 85,0 | 91,0 | 75,8 | 26,2 | 108,0 | 87,0 | 108,0 | 87,0 | 46 | | | | | | |
| 50 | - | - | - | - | 20,1 | 97,3 | 79,0 | 92,5 | 81,3 | 86,3 | 72,5 | 21,2 | 102,5 | 83,3 | 102,5 | 83,3 | 50 | | | | | | |
| 54 | - | - | - | - | 15,7 | 92,0 | 76,0 | 87,5 | 78,0 | 82,0 | 69,5 | 16,6 | 97,5 | 80,0 | 97,5 | 80,0 | 54 | | | | | | |
| 58 | - | - | - | - | 12,0 | 87,3 | 73,0 | 83,0 | 74,6 | 78,3 | 66,8 | 12,6 | 93,1 | 77,0 | 93,1 | 77,0 | 58 | | | | | | |
| 62 | - | - | - | - | 8,7 | 83,3 | 70,3 | 79,3 | 71,6 | 75,1 | 64,5 | 9,0 | 89,1 | 74,1 | 89,1 | 74,1 | 62 | | | | | | |
| 66 | - | - | - | - | 5,7 | 80,0 | 68,0 | 76,0 | 69,0 | 72,0 | 62,0 | 5,9 | 85,5 | 71,5 | 85,5 | 71,5 | 66 | | | | | | |
| 69 | - | - | - | - | 3,8 | 78,0 | 66,3 | 74,1 | 67,3 | 70,0 | 60,5 | 3,9 | 83,2 | 70,0 | 83,4 | 70,0 | 69 | | | | | | |
| 70 | - | - | - | - | - | 77,1 | 65,7 | 73,4 | 66,7 | 69,3 | 60,0 | - | 82,5 | 69,5 | 82,6 | 69,5 | 70 | | | | | | |
| 74 | - | - | - | - | - | 74,1 | 63,5 | 70,6 | 64,6 | 66,8 | 58,1 | - | 79,5 | 67,5 | 79,5 | 67,5 | 74 | | | | | | |
| 78 | - | - | - | - | - | 71,5 | 61,5 | 68,0 | 63,0 | 64,5 | 56,5 | - | 76,5 | 65,5 | 76,5 | 65,5 | 78 | | | | | | |
| 82 | - | - | - | - | - | 69,1 | 59,8 | 65,6 | 61,3 | 62,5 | 54,8 | - | 74,1 | 63,8 | 74,1 | 63,8 | 82 | | | | | | |
| 86 | - | - | - | - | - | 66,0 | 58,3 | 63,5 | 59,6 | 60,6 | 53,5 | - | 71,1 | 62,3 | 71,0 | 62,3 | 86 | | | | | | |
| 90 | - | - | - | - | - | 62,0 | 57,0 | 61,5 | 58,0 | 59,0 | 52,5 | - | 67,5 | 61,0 | 67,0 | 61,0 | 90 | | | | | | |
| 94 | - | - | - | - | - | 58,0 | 55,6 | 57,5 | 56,3 | 55,0 | 51,0 | - | 63,1 | 59,6 | 62,6 | 59,6 | 94 | | | | | | |
| 98 | - | - | - | - | - | 54,2 | 53,8 | 53,5 | 53,5 | 51,2 | 49,6 | - | 59,0 | 58,0 | 58,5 | 57,7 | 98 | | | | | | |
| 102 | - | - | - | - | - | 51,0 | 51,0 | 50,0 | 50,5 | 47,8 | 47,9 | - | 55,5 | 55,5 | 55,0 | 55,0 | 102 | | | | | | |
| 106 | - | - | - | - | - | 48,0 | 48,2 | 47,0 | 47,3 | 44,5 | 44,5 | - | 52,1 | 52,0 | 51,6 | 51,5 | 106 | | | | | | |
| 109 | - | - | - | - | - | 45,8 | - | 44,9 | - | 42,2 | - | - | 49,8 | - | 49,1 | - | 109 | | | | | | |



| 165 t + 50 t | | 8,40 m | | 9.8 m/s | | 360° | | ISO | | | | | | | | | | | | | | | | | | | |
|--------------|-------|--------|-------|-------------|-------|-------|-------|----------|-------|-------|-------|-------------|-------|-------|-------|----------|-------|-------|-----|-------------|--|--|--|-----------|--|--|--|
| 114 m | | | | | | | | | | | | | | | | | | | | | | | | | | | |
| LSL+LF_2 | | | | LSL+LF_3 | | | | LSL+LF_4 | | | | LSL+LF_6 | | | | LSL+LF_8 | | | | LSL+LF_10 | | | | LSL+LF_12 | | | |
| 12 m | | | | | | | | | | | | | | | | | | | | | | | | | | | |
| 0 t | | | | 0 t - 325 t | | | | 0 t | | | | 0 t - 325 t | | | | 0 t | | | | 0 t - 325 t | | | | | | | |
| 15° | | 20° | | 30° | | 15° | | 20° | | 15° | | 20° | | 15° | | 20° | | 15° | | 20° | | | | | | | |
| m | t | t | t | t | t | t | t | t | t | t | t | t | t | t | t | t | t | t | t | m | | | | | | | |
| 16 | 108,0 | 128,0 | - | - | - | - | - | 133,0 | - | 145,0 | - | 114,0 | 160,0 | - | 165,0 | - | 170,0 | - | 16 | | | | | | | | |
| 17 | 102,2 | 128,0 | 120,0 | - | 100,0 | 131,0 | 113,0 | 132,5 | 115,0 | 145,0 | 116,0 | 107,5 | 160,0 | 130,0 | 165,0 | 130,0 | 170,0 | 130,0 | 17 | | | | | | | | |
| 18 | 96,5 | 128,0 | 120,0 | - | 95,0 | 131,0 | 113,0 | 132,0 | 115,0 | 145,0 | 114,0 | 101,0 | 160,0 | 128,0 | 165,0 | 128,0 | 170,0 | 128,0 | 18 | | | | | | | | |
| 19 | 91,2 | 128,0 | 120,0 | 80,0 | 89,7 | 131,0 | 112,5 | 132,0 | 114,5 | 143,5 | 112,0 | 95,7 | 160,0 | 126,0 | 164,5 | 126,0 | 169,0 | 126,0 | 19 | | | | | | | | |
| 20 | 86,0 | 128,0 | 120,0 | 79,0 | 84,5 | 131,0 | 112,0 | 132,0 | 114,0 | 142,0 | 110,0 | 90,5 | 160,0 | 124,0 | 164,0 | 124,0 | 168,0 | 124,0 | 20 | | | | | | | | |
| 22 | 77,0 | 128,0 | 119,0 | 77,0 | 76,5 | 130,5 | 111,0 | 131,5 | 113,0 | 136,5 | 107,0 | 81,7 | 157,5 | 120,0 | 159,5 | 120,0 | 161,5 | 120,0 | 22 | | | | | | | | |
| 24 | 69,5 | 127,0 | 115,0 | 75,5 | 68,5 | 130,0 | 110,0 | 131,0 | 112,0 | 131,0 | 103,0 | 73,0 | 155,0 | 116,0 | 155,0 | 116,0 | 155,0 | 116,0 | 24 | | | | | | | | |
| 26 | 63,0 | 126,0 | 111,0 | 73,5 | 62,2 | 127,5 | 107,0 | 129,0 | 110,0 | 126,5 | 100,0 | 66,2 | 149,5 | 113,0 | 149,5 | 113,0 | 149,5 | 113,0 | 26 | | | | | | | | |
| 28 | 57,0 | 125,0 | 108,0 | 72,0 | 56,0 | 125,0 | 104,0 | 127,0 | 108,0 | 122,0 | 97,0 | 59,5 | 144,0 | 109,0 | 144,0 | 109,0 | 144,0 | 109,0 | 28 | | | | | | | | |
| 30 | 51,5 | 124,0 | 105,0 | 70,5 | 51,1 | 122,5 | 101,0 | 124,5 | 105,0 | 117,5 | 94,0 | 54,4 | 139,0 | 106,0 | 139,0 | 106,0 | 139,0 | 106,0 | 30 | | | | | | | | |
| 34 | 43,3 | 121,3 | 99,3 | 67,5 | 42,3 | 117,5 | 95,6 | 120,0 | 99,3 | 109,5 | 89,0 | 45,1 | 130,0 | 101,0 | 130,0 | 101,0 | 130,0 | 101,0 | 34 | | | | | | | | |
| 38 | 36,0 | 116,6 | 94,1 | 64,8 | 35,2 | 112,3 | 90,6 | 115,3 | 94,3 | 103,1 | 84,5 | 37,5 | 122,3 | 96,1 | 122,3 | 96,1 | 122,3 | 96,1 | 38 | | | | | | | | |
| 42 | 29,7 | 110,0 | 89,5 | 62,5 | 29,0 | 107,0 | 86,0 | 110,0 | 90,0 | 97,5 | 80,5 | 30,9 | 115,0 | 91,5 | 115,0 | 91,5 | 115,0 | 91,5 | 42 | | | | | | | | |
| 46 | 24,7 | 104,0 | 85,5 | 60,5 | 24,0 | 101,3 | 82,0 | 104,3 | 86,0 | 92,1 | 76,8 | 25,7 | 109,0 | 87,5 | 109,0 | 87,5 | 109,0 | 87,5 | 46 | | | | | | | | |
| 50 | 20,1 | 98,6 | 81,8 | 58,5 | 19,4 | 95,1 | 78,3 | 98,6 | 82,3 | 87,5 | 73,3 | 20,8 | 103,6 | 83,8 | 103,6 | 83,8 | 103,6 | 83,8 | 50 | | | | | | | | |
| 54 | 15,8 | 94,0 | 78,5 | 56,5 | 15,2 | 88,5 | 75,0 | 94,0 | 79,0 | 83,5 | 70,0 | 16,2 | 99,0 | 80,5 | 99,0 | 80,5 | 99,0 | 80,5 | 54 | | | | | | | | |
| 58 | 12,0 | 89,6 | 75,5 | 54,8 | 11,4 | 81,0 | 72,3 | 89,1 | 75,6 | 79,8 | 67,3 | 12,2 | 94,6 | 77,8 | 94,6 | 77,8 | 94,6 | 77,8 | 58 | | | | | | | | |
| 62 | 8,7 | 85,6 | 72,6 | 53,3 | 8,1 | 76,6 | 69,3 | 85,5 | 72,6 | 76,2 | 65,0 | 8,7 | 89,8 | 75,1 | 90,6 | 75,1 | 90,6 | 75,1 | 62 | | | | | | | | |
| 66 | 5,7 | 82,0 | 70,0 | 52,0 | 5,2 | 73,0 | 67,0 | 82,5 | 70,0 | 73,0 | 62,5 | 5,5 | 86,5 | 72,5 | 87,0 | 72,5 | 87,0 | 72,5 | 66 | | | | | | | | |
| 68 | 4,3 | 80,6 | 69,0 | 51,5 | 3,9 | 70,8 | 66,0 | 80,8 | 69,0 | 71,6 | 61,5 | 4,1 | 84,5 | 71,5 | 85,2 | 71,5 | 85,3 | 71,4 | 68 | | | | | | | | |
| 69 | 3,7 | 80,0 | 68,5 | 51,2 | - | 70,1 | 65,5 | 80,1 | 68,5 | 71,0 | 61,0 | 3,5 | 83,6 | 70,8 | 84,4 | 70,8 | 84,5 | 70,8 | 69 | | | | | | | | |
| 70 | - | 79,1 | 67,8 | 51,0 | - | 69,4 | 65,0 | 79,4 | 68,0 | 70,3 | 60,5 | - | 82,7 | 70,2 | 83,6 | 70,2 | 83,6 | 70,2 | 70 | | | | | | | | |
| 74 | - | 76,1 | 65,5 | 50,0 | - | 66,3 | 63,0 | 76,3 | 66,0 | 67,8 | 58,6 | - | 79,6 | 68,0 | 80,6 | 68,0 | 80,6 | 68,0 | 74 | | | | | | | | |
| 78 | - | 73,5 | 63,5 | 49,0 | - | 64,0 | 61,0 | 73,0 | 64,0 | 65,5 | 57,0 | - | 77,0 | 66,0 | 78,0 | 66,0 | 78,0 | 66,0 | 78 | | | | | | | | |
| 82 | - | 70,5 | 61,8 | 48,1 | - | 62,3 | 59,1 | 69,6 | 62,3 | 63,5 | 55,6 | - | 73,6 | 64,3 | 75,3 | 64,3 | 74,6 | 64,3 | 82 | | | | | | | | |
| 86 | - | 66,6 | 60,3 | 47,3 | - | 61,0 | 57,8 | 65,6 | 60,8 | 61,1 | 54,3 | - | 70,3 | 62,8 | 71,5 | 62,8 | 70,5 | 62,8 | 86 | | | | | | | | |
| 90 | - | 62,0 | 59,0 | 46,6 | - | 60,0 | 56,5 | 61,0 | 59,5 | 58,5 | 53,0 | - | 67,0 | 61,5 | 66,5 | 61,5 | 65,5 | 61,5 | 90 | | | | | | | | |
| 94 | - | 58,0 | 57,0 | 46,0 | - | 57,0 | 55,5 | 57,0 | 56,8 | 54,1 | 51,6 | - | 62,6 | 60,1 | 62,1 | 60,1 | 61,5 | 60,1 | 94 | | | | | | | | |
| 96 | - | 56,0 | 56,0 | 39,7 | - | 55,5 | 55,0 | 55,0 | 55,5 | 52,0 | 51,0 | - | 60,5 | 59,5 | 60,0 | 59,5 | 59,5 | 59,5 | 96 | | | | | | | | |
| 98 | - | 54,2 | 54,2 | - | - | 53,8 | 53,6 | 53,2 | 53,5 | 50,3 | 49,6 | - | 58,7 | 58,2 | 58,0 | 58,1 | 57,5 | 57,5 | 98 | | | | | | | | |
| 102 | - | 51,0 | 51,0 | - | - | 50,5 | 50,5 | 50,0 | 50,0 | 46,9 | 46,8 | - | 55,0 | 55,0 | 54,5 | 54,5 | 53,5 | 53,5 | 102 | | | | | | | | |
| 106 | - | 47,8 | 47,9 | - | - | 47,5 | 47,5 | 46,8 | 46,9 | 43,6 | 43,3 | - | 51,6 | 51,6 | 51,2 | 51,3 | 50,2 | 50,3 | 106 | | | | | | | | |
| 108 | - | 46,3 | 46,4 | - | - | 46,0 | 46,1 | 45,3 | 45,4 | 42,1 | 41,7 | - | 50,0 | 50,0 | 49,6 | 49,7 | 48,6 | 48,7 | 108 | | | | | | | | |
| 109 | - | 45,5 | 40,6 | - | - | 45,2 | 30,1 | 44,6 | 30,1 | 41,3 | - | - | 49,2 | - | 48,8 | - | 47,8 | - | 109 | | | | | | | | |
| 110 | - | 44,8 | - | - | - | 44,5 | - | 43,9 | - | 40,6 | - | - | 48,5 | - | 48,0 | - | 47,0 | - | 110 | | | | | | | | |
| 112 | - | 43,4 | - | - | - | 43,1 | - | 42,5 | - | 39,2 | - | - | 47,0 | - | 46,5 | - | 45,5 | - | 112 | | | | | | | | |

| | | | | | | | | |
|---|-----|------|------|-------|-------|-------|-------|-------|
|  | 0 t | 65 t | 95 t | 125 t | 165 t | 205 t | 265 t | 325 t |
|---|-----|------|------|-------|-------|-------|-------|-------|

| 165 t + 50 t | | 8,40 m | | 9.8 m/s | | 360° | | ISO | | | | | | | | | | | | | | | | | | | |
|--------------|---|--------|---|-------------|------|-------|-------|----------|-------|-------|-------|-------------|-------|-------|-------|----------|-------|-------|-----|-------------|--|--|--|-----------|--|--|--|
| 117 m | | | | | | | | | | | | | | | | | | | | | | | | | | | |
| LSL+LF_2 | | | | LSL+LF_3 | | | | LSL+LF_4 | | | | LSL+LF_6 | | | | LSL+LF_8 | | | | LSL+LF_10 | | | | LSL+LF_12 | | | |
| 12 m | | | | | | | | | | | | | | | | | | | | | | | | | | | |
| 0 t | | | | 0 t - 325 t | | | | 0 t | | | | 0 t - 325 t | | | | 0 t | | | | 0 t - 325 t | | | | | | | |
| 15° | | | | 20° | | | | 30° | | | | 15° | | | | 20° | | | | 15° | | | | 20° | | | |
| m | t | t | t | t | t | t | t | t | t | t | t | t | t | t | t | t | t | t | t | m | | | | | | | |
| 16 | - | - | - | - | - | - | - | 129,0 | - | 140,0 | - | 111,0 | 155,0 | - | 160,0 | - | 165,0 | - | 16 | | | | | | | | |
| 17 | - | - | - | - | 98,0 | 127,0 | 111,0 | 129,0 | 114,0 | 140,0 | 117,0 | 105,0 | 155,0 | 131,0 | 160,0 | 131,0 | 165,0 | 131,0 | 17 | | | | | | | | |
| 18 | - | - | - | - | 92,5 | 127,0 | 111,0 | 129,0 | 114,0 | 140,0 | 115,0 | 99,0 | 155,0 | 129,0 | 160,0 | 129,0 | 165,0 | 129,0 | 18 | | | | | | | | |
| 20 | - | - | - | - | 82,5 | 127,0 | 111,0 | 129,0 | 113,0 | 140,0 | 111,0 | 88,0 | 155,0 | 124,0 | 159,0 | 124,0 | 165,0 | 124,0 | 20 | | | | | | | | |
| 22 | - | - | - | - | 74,5 | 127,0 | 110,0 | 129,0 | 113,0 | 136,0 | 107,0 | 79,5 | 154,5 | 120,0 | 157,5 | 120,0 | 160,5 | 120,0 | 22 | | | | | | | | |
| 24 | - | - | - | - | 66,5 | 127,0 | 110,0 | 129,0 | 112,0 | 132,0 | 104,0 | 71,0 | 154,0 | 117,0 | 156,0 | 117,0 | 156,0 | 117,0 | 24 | | | | | | | | |
| 26 | - | - | - | - | 60,2 | 125,5 | 108,0 | 127,5 | 111,0 | 127,5 | 100,0 | 64,5 | 149,5 | 113,0 | 150,5 | 113,0 | 150,5 | 113,0 | 26 | | | | | | | | |
| 28 | - | - | - | - | 54,0 | 124,0 | 105,0 | 126,0 | 108,0 | 123,0 | 97,5 | 58,0 | 145,0 | 110,0 | 145,0 | 110,0 | 145,0 | 110,0 | 28 | | | | | | | | |
| 30 | - | - | - | - | 49,3 | 122,5 | 102,0 | 124,0 | 106,0 | 118,5 | 95,0 | 52,8 | 140,0 | 107,0 | 140,0 | 107,0 | 140,0 | 107,0 | 30 | | | | | | | | |
| 34 | - | - | - | - | 40,7 | 119,0 | 97,0 | 120,5 | 100,6 | 110,5 | 90,0 | 43,5 | 131,0 | 102,0 | 131,0 | 102,0 | 131,0 | 102,0 | 34 | | | | | | | | |
| 38 | - | - | - | - | 33,7 | 114,3 | 92,1 | 116,3 | 95,6 | 104,1 | 85,3 | 35,9 | 123,3 | 97,1 | 123,3 | 97,1 | 123,3 | 97,1 | 38 | | | | | | | | |
| 42 | - | - | - | - | 27,5 | 109,0 | 87,5 | 111,0 | 91,0 | 98,5 | 81,0 | 29,3 | 116,0 | 92,5 | 116,0 | 92,5 | 116,0 | 92,5 | 42 | | | | | | | | |
| 46 | - | - | - | - | 22,6 | 103,6 | 83,5 | 105,6 | 87,3 | 93,5 | 77,3 | 24,1 | 110,0 | 88,5 | 110,0 | 88,5 | 110,0 | 88,5 | 46 | | | | | | | | |
| 50 | - | - | - | - | 18,1 | 96,5 | 79,6 | 100,6 | 83,6 | 88,8 | 74,0 | 19,4 | 104,6 | 84,8 | 104,6 | 84,8 | 104,6 | 84,8 | 50 | | | | | | | | |
| 54 | - | - | - | - | 14,1 | 91,5 | 76,0 | 96,0 | 80,0 | 84,5 | 71,0 | 15,1 | 100,0 | 81,5 | 100,0 | 81,5 | 100,0 | 81,5 | 54 | | | | | | | | |
| 58 | - | - | - | - | 10,3 | 86,1 | 73,3 | 90,8 | 77,0 | 80,8 | 68,3 | 11,1 | 95,6 | 78,5 | 95,6 | 78,5 | 95,6 | 78,5 | 58 | | | | | | | | |
| 62 | - | - | - | - | 7,0 | 79,6 | 70,3 | 87,0 | 74,1 | 77,3 | 65,9 | 7,6 | 91,6 | 75,8 | 91,7 | 75,8 | 91,7 | 75,8 | 62 | | | | | | | | |
| 66 | - | - | - | - | 4,1 | 76,5 | 68,0 | 84,0 | 71,5 | 74,0 | 63,5 | 4,4 | 88,0 | 73,0 | 88,0 | 73,0 | 88,0 | 73,0 | 66 | | | | | | | | |
| 67 | - | - | - | - | - | 75,5 | 67,5 | 83,2 | 70,9 | 73,3 | 63,0 | 3,7 | 87,1 | 72,5 | 87,1 | 72,5 | 87,1 | 72,5 | 67 | | | | | | | | |
| 70 | - | - | - | - | - | 72,6 | 65,7 | 81,0 | 69,1 | 71,3 | 61,5 | - | 84,6 | 71,0 | 84,6 | 71,0 | 84,6 | 71,0 | 70 | | | | | | | | |
| 74 | - | - | - | - | - | 70,3 | 63,6 | 78,0 | 67,0 | 68,6 | 59,5 | - | 81,6 | 69,0 | 81,6 | 69,0 | 81,6 | 69,0 | 74 | | | | | | | | |
| 78 | - | - | - | - | - | 68,0 | 62,0 | 75,0 | 65,0 | 66,0 | 57,5 | - | 79,0 | 67,0 | 79,0 | 67,0 | 79,0 | 67,0 | 78 | | | | | | | | |
| 82 | - | - | - | - | - | 66,0 | 60,3 | 69,6 | 63,3 | 64,0 | 56,1 | - | 75,3 | 65,3 | 75,0 | 65,3 | 74,3 | 65,3 | 82 | | | | | | | | |
| 86 | - | - | - | - | - | 63,5 | 58,6 | 64,6 | 61,8 | 61,2 | 54,7 | - | 71,0 | 63,6 | 70,5 | 63,6 | 69,5 | 63,6 | 86 | | | | | | | | |
| 90 | - | - | - | - | - | 60,5 | 57,0 | 60,0 | 60,5 | 57,5 | 53,5 | - | 66,0 | 62,0 | 65,5 | 62,0 | 64,5 | 62,0 | 90 | | | | | | | | |
| 94 | - | - | - | - | - | 56,5 | 55,6 | 56,0 | 56,5 | 53,1 | 51,8 | - | 61,6 | 60,3 | 61,1 | 60,0 | 60,0 | 60,5 | 94 | | | | | | | | |
| 98 | - | - | - | - | - | 52,8 | 53,2 | 52,7 | 52,7 | 49,2 | 49,1 | - | 57,5 | 57,5 | 57,0 | 57,1 | 56,1 | 56,5 | 98 | | | | | | | | |
| 102 | - | - | - | - | - | 49,6 | 49,7 | 49,1 | 49,3 | 45,7 | 45,3 | - | 53,5 | 54,0 | 53,0 | 53,5 | 52,5 | 52,5 | 102 | | | | | | | | |
| 106 | - | - | - | - | - | 46,4 | 46,5 | 45,1 | 46,0 | 42,5 | 41,8 | - | 49,9 | 50,6 | 49,5 | 50,1 | 48,9 | 49,1 | 106 | | | | | | | | |
| 110 | - | - | - | - | - | 43,3 | 43,4 | 40,9 | 42,9 | 39,4 | 38,6 | - | 46,7 | 47,4 | 46,3 | 46,8 | 45,6 | 45,8 | 110 | | | | | | | | |
| 111 | - | - | - | - | - | 42,6 | 42,7 | 39,8 | 42,2 | 38,6 | 37,9 | - | 45,9 | 46,6 | 45,6 | 46,1 | 44,9 | 45,0 | 111 | | | | | | | | |
| 114 | - | - | - | - | - | 40,5 | - | 36,5 | - | 36,4 | - | - | 43,9 | - | 43,6 | - | 42,7 | - | 114 | | | | | | | | |
| 115 | - | - | - | - | - | 39,9 | - | 35,4 | - | 35,7 | - | - | 43,3 | - | 42,9 | - | 42,0 | - | 115 | | | | | | | | |



| 165 t + 50 t | | 8,40 m | | 9.8 m/s | | 360° | | ISO | | | | | | | | | | | | | | | | | | | |
|--------------|-------|--------|-------|-------------|------|-------|-------|----------|-------|-------|-------|-------------|-------|-------|-------|----------|-------|-------|-----|-------------|--|--|--|-----------|--|--|--|
| 120 m | | | | | | | | | | | | | | | | | | | | | | | | | | | |
| LSL+LF_2 | | | | LSL+LF_3 | | | | LSL+LF_4 | | | | LSL+LF_6 | | | | LSL+LF_8 | | | | LSL+LF_10 | | | | LSL+LF_12 | | | |
| 12 m | | | | | | | | | | | | | | | | | | | | | | | | | | | |
| 0 t | | | | 0 t - 325 t | | | | 0 t | | | | 0 t - 325 t | | | | 0 t | | | | 0 t - 325 t | | | | | | | |
| 15° | | | | 20° | | | | 30° | | | | 15° | | | | 20° | | | | 15° | | | | 20° | | | |
| m | t | t | t | t | t | t | t | t | t | t | t | t | t | t | t | t | t | t | t | m | | | | | | | |
| 16 | 104,0 | 114,0 | - | - | - | - | - | 124,0 | - | 135,0 | - | - | - | - | - | - | - | - | - | 16 | | | | | | | |
| 17 | 98,5 | 113,5 | 108,0 | - | 96,5 | 123,0 | 109,0 | 124,0 | 111,0 | 135,0 | 117,0 | 102,0 | 149,0 | - | 154,0 | - | 159,0 | - | 17 | | | | | | | | |
| 18 | 93,0 | 113,0 | 108,0 | - | 90,5 | 123,0 | 109,0 | 124,0 | 111,0 | 135,0 | 115,0 | 97,0 | 149,0 | 129,0 | 154,0 | 129,0 | 159,0 | 129,0 | 18 | | | | | | | | |
| 19 | 88,0 | 113,0 | 108,0 | 80,5 | 85,7 | 123,0 | 109,0 | 124,0 | 111,0 | 135,0 | 113,0 | 91,7 | 149,0 | 127,0 | 154,0 | 127,0 | 159,0 | 127,0 | 19 | | | | | | | | |
| 20 | 83,0 | 113,0 | 108,0 | 79,5 | 81,0 | 123,0 | 109,0 | 124,0 | 111,0 | 135,0 | 111,0 | 86,5 | 149,0 | 125,0 | 154,0 | 125,0 | 159,0 | 125,0 | 20 | | | | | | | | |
| 22 | 74,5 | 112,0 | 108,0 | 77,5 | 73,0 | 122,5 | 108,0 | 124,0 | 111,0 | 134,0 | 108,0 | 78,0 | 149,0 | 121,0 | 153,5 | 121,0 | 158,0 | 121,0 | 22 | | | | | | | | |
| 24 | 67,0 | 112,0 | 108,0 | 76,0 | 65,0 | 122,0 | 108,0 | 124,0 | 111,0 | 133,0 | 104,0 | 69,5 | 149,0 | 117,0 | 153,0 | 117,0 | 157,0 | 117,0 | 24 | | | | | | | | |
| 26 | 60,5 | 111,0 | 108,0 | 74,0 | 59,0 | 120,0 | 107,0 | 123,5 | 111,0 | 128,5 | 101,0 | 63,0 | 147,5 | 114,0 | 149,5 | 114,0 | 151,5 | 114,0 | 26 | | | | | | | | |
| 28 | 54,5 | 110,0 | 107,0 | 72,5 | 53,0 | 118,0 | 104,0 | 123,0 | 109,0 | 124,0 | 98,5 | 56,5 | 146,0 | 111,0 | 146,0 | 111,0 | 146,0 | 111,0 | 28 | | | | | | | | |
| 30 | 49,8 | 110,0 | 106,0 | 71,0 | 48,2 | 116,0 | 101,0 | 122,0 | 107,0 | 120,0 | 95,5 | 51,4 | 141,5 | 108,0 | 141,5 | 108,0 | 141,5 | 108,0 | 30 | | | | | | | | |
| 34 | 41,5 | 108,6 | 101,0 | 68,3 | 39,6 | 111,5 | 96,3 | 120,5 | 101,6 | 112,0 | 90,5 | 42,2 | 132,5 | 102,6 | 132,5 | 102,6 | 132,5 | 102,6 | 34 | | | | | | | | |
| 38 | 34,3 | 107,0 | 96,1 | 65,6 | 32,6 | 106,6 | 91,8 | 117,6 | 96,8 | 105,1 | 85,8 | 34,8 | 124,6 | 97,6 | 124,6 | 97,6 | 124,6 | 97,6 | 38 | | | | | | | | |
| 42 | 28,1 | 105,0 | 91,5 | 63,0 | 26,4 | 102,0 | 87,5 | 113,0 | 92,5 | 99,5 | 81,5 | 28,3 | 118,0 | 93,0 | 118,0 | 93,0 | 118,0 | 93,0 | 42 | | | | | | | | |
| 46 | 23,2 | 102,3 | 87,1 | 61,0 | 21,6 | 96,6 | 83,5 | 107,6 | 88,5 | 94,5 | 78,1 | 23,1 | 112,0 | 89,3 | 112,0 | 89,3 | 112,0 | 89,3 | 46 | | | | | | | | |
| 50 | 18,8 | 97,1 | 83,3 | 59,1 | 17,2 | 91,3 | 79,8 | 102,5 | 84,6 | 89,8 | 74,8 | 18,5 | 106,3 | 85,6 | 106,3 | 85,6 | 106,3 | 85,6 | 50 | | | | | | | | |
| 54 | 14,8 | 94,5 | 80,0 | 57,5 | 13,4 | 86,0 | 76,5 | 97,5 | 81,0 | 85,5 | 71,5 | 14,4 | 101,0 | 82,0 | 101,0 | 82,0 | 101,0 | 82,0 | 54 | | | | | | | | |
| 58 | 11,0 | 89,3 | 77,0 | 55,8 | 9,6 | 78,0 | 73,5 | 92,5 | 78,0 | 81,8 | 69,0 | 10,4 | 96,6 | 79,3 | 96,6 | 79,3 | 96,6 | 79,3 | 58 | | | | | | | | |
| 62 | 7,6 | 85,6 | 74,1 | 54,3 | 6,2 | 73,5 | 69,6 | 88,5 | 75,2 | 78,3 | 66,4 | 6,8 | 92,7 | 76,6 | 92,7 | 76,6 | 92,8 | 76,6 | 62 | | | | | | | | |
| 65 | 5,3 | 82,2 | 72,1 | 53,3 | 4,0 | 71,1 | 66,2 | 86,2 | 73,2 | 75,8 | 64,6 | 4,4 | 89,5 | 74,6 | 90,0 | 74,6 | 90,0 | 74,6 | 65 | | | | | | | | |
| 66 | 4,6 | 81,5 | 71,5 | 53,0 | - | 70,5 | 65,5 | 85,5 | 72,5 | 75,0 | 64,0 | 3,7 | 89,0 | 74,0 | 89,0 | 74,0 | 89,0 | 74,0 | 66 | | | | | | | | |
| 67 | 3,9 | 80,8 | 71,0 | 52,6 | - | 69,1 | 64,9 | 84,7 | 71,9 | 74,3 | 63,5 | - | 88,1 | 73,4 | 88,1 | 73,4 | 88,1 | 73,4 | 67 | | | | | | | | |
| 70 | - | 78,8 | 69,2 | 51,6 | - | 66,3 | 63,1 | 82,5 | 70,1 | 72,3 | 62,0 | - | 85,6 | 71,6 | 85,6 | 71,6 | 85,6 | 71,6 | 70 | | | | | | | | |
| 74 | - | 75,8 | 67,0 | 50,5 | - | 63,8 | 60,0 | 78,8 | 68,0 | 69,6 | 60,1 | - | 82,6 | 69,5 | 82,6 | 69,5 | 82,6 | 69,5 | 74 | | | | | | | | |
| 78 | - | 73,5 | 65,0 | 49,6 | - | 61,5 | 58,0 | 74,5 | 66,0 | 67,0 | 58,5 | - | 80,0 | 67,5 | 80,0 | 67,5 | 80,0 | 67,5 | 78 | | | | | | | | |
| 82 | - | 69,8 | 63,3 | 48,6 | - | 59,0 | 56,1 | 69,1 | 64,3 | 64,6 | 56,8 | - | 75,3 | 65,8 | 75,0 | 65,8 | 74,3 | 65,8 | 82 | | | | | | | | |
| 86 | - | 65,6 | 61,6 | 47,8 | - | 57,5 | 55,0 | 64,1 | 62,1 | 61,0 | 55,3 | - | 70,5 | 64,1 | 70,0 | 64,1 | 69,0 | 64,1 | 86 | | | | | | | | |
| 90 | - | 61,0 | 60,0 | 47,1 | - | 56,5 | 54,0 | 59,5 | 59,5 | 56,5 | 54,0 | - | 65,5 | 62,5 | 65,0 | 62,5 | 64,0 | 62,5 | 90 | | | | | | | | |
| 94 | - | 57,0 | 56,6 | 46,4 | - | 55,5 | 53,2 | 55,5 | 55,5 | 52,1 | 51,1 | - | 61,1 | 60,1 | 60,5 | 60,1 | 59,7 | 59,8 | 94 | | | | | | | | |
| 98 | - | 53,2 | 53,6 | 45,9 | - | 52,2 | 51,6 | 51,4 | 51,7 | 48,4 | 47,7 | - | 56,8 | 57,1 | 56,3 | 56,5 | 55,5 | 55,5 | 98 | | | | | | | | |
| 100 | - | 51,6 | 51,8 | 45,7 | - | 50,5 | 50,2 | 49,4 | 50,0 | 46,6 | 45,7 | - | 54,6 | 55,3 | 54,1 | 54,5 | 53,5 | 53,5 | 100 | | | | | | | | |
| 102 | - | 50,0 | 50,0 | - | - | 48,8 | 48,9 | 47,4 | 48,3 | 44,8 | 43,8 | - | 52,5 | 53,5 | 52,0 | 52,5 | 51,5 | 51,5 | 102 | | | | | | | | |
| 106 | - | 46,7 | 46,8 | - | - | 45,5 | 45,7 | 41,8 | 44,9 | 41,4 | 40,2 | - | 48,9 | 49,9 | 48,4 | 49,3 | 47,8 | 48,3 | 106 | | | | | | | | |
| 110 | - | 43,7 | 43,8 | - | - | 42,5 | 42,6 | 36,3 | 39,3 | 38,1 | 36,9 | - | 45,5 | 46,6 | 45,2 | 46,1 | 44,5 | 45,1 | 110 | | | | | | | | |
| 113 | - | 41,6 | 41,7 | - | - | 40,4 | 40,5 | 33,6 | 34,5 | 35,7 | 34,7 | - | 43,3 | 44,3 | 42,9 | 43,8 | 42,2 | 42,8 | 113 | | | | | | | | |
| 114 | - | 40,9 | 41,0 | - | - | 39,7 | 34,9 | 32,7 | 16,8 | 35,0 | - | - | 42,6 | - | 42,2 | - | 41,5 | - | 114 | | | | | | | | |
| 117 | - | 38,9 | - | - | - | 37,8 | - | 28,7 | - | 33,0 | - | - | 40,7 | - | 40,3 | - | 39,6 | - | 117 | | | | | | | | |

| | | | | | | | | |
|--|----|-----|-----|------|------|------|------|------|
| | 0t | 65t | 95t | 125t | 165t | 205t | 265t | 325t |
|--|----|-----|-----|------|------|------|------|------|

| 165 t + 50 t | | 8,40 m | | 9.8 m/s | | 360° | | ISO | | | | | | | | | | | | | | | | | | | |
|--------------|---|--------|---|-------------|------|-------|-------|----------|-------|-------|-------|-------------|-------|-------|-------|----------|-------|-------|-----|-------------|--|--|--|-----------|--|--|--|
| 123 m | | | | | | | | | | | | | | | | | | | | | | | | | | | |
| LSL+LF_2 | | | | LSL+LF_3 | | | | LSL+LF_4 | | | | LSL+LF_6 | | | | LSL+LF_8 | | | | LSL+LF_10 | | | | LSL+LF_12 | | | |
| 12 m | | | | | | | | | | | | | | | | | | | | | | | | | | | |
| 0 t | | | | 0 t - 325 t | | | | 0 t | | | | 0 t - 325 t | | | | 0 t | | | | 0 t - 325 t | | | | | | | |
| 15° | | | | 20° | | | | 30° | | | | 15° | | | | 20° | | | | 15° | | | | 20° | | | |
| m | t | t | t | t | t | t | t | t | t | t | t | t | t | t | t | t | t | t | t | m | | | | | | | |
| 17 | - | - | - | - | - | - | - | 120,0 | - | 129,0 | - | 100,0 | 143,0 | - | 148,0 | - | 154,0 | - | 17 | | | | | | | | |
| 18 | - | - | - | - | 88,5 | 119,0 | 106,0 | 120,0 | 109,0 | 129,0 | 116,0 | 94,5 | 143,0 | 130,0 | 148,0 | 130,0 | 154,0 | 130,0 | 18 | | | | | | | | |
| 20 | - | - | - | - | 78,5 | 119,0 | 106,0 | 120,0 | 109,0 | 129,0 | 112,0 | 84,0 | 143,0 | 125,0 | 148,0 | 125,0 | 154,0 | 125,0 | 20 | | | | | | | | |
| 22 | - | - | - | - | 70,7 | 119,0 | 106,0 | 120,0 | 109,0 | 129,0 | 108,0 | 75,7 | 143,0 | 122,0 | 148,0 | 122,0 | 153,5 | 122,0 | 22 | | | | | | | | |
| 24 | - | - | - | - | 63,0 | 119,0 | 106,0 | 120,0 | 109,0 | 129,0 | 105,0 | 67,5 | 143,0 | 118,0 | 148,0 | 118,0 | 153,0 | 118,0 | 24 | | | | | | | | |
| 26 | - | - | - | - | 57,0 | 118,0 | 106,0 | 119,5 | 109,0 | 127,0 | 102,0 | 61,0 | 143,0 | 115,0 | 147,0 | 115,0 | 150,0 | 115,0 | 26 | | | | | | | | |
| 28 | - | - | - | - | 51,0 | 117,0 | 103,0 | 119,0 | 108,0 | 125,0 | 99,0 | 54,5 | 143,0 | 112,0 | 147,0 | 112,0 | 147,0 | 112,0 | 28 | | | | | | | | |
| 30 | - | - | - | - | 46,4 | 115,5 | 101,0 | 118,0 | 106,0 | 121,0 | 96,0 | 49,6 | 140,5 | 109,0 | 142,5 | 109,0 | 142,5 | 109,0 | 30 | | | | | | | | |
| 34 | - | - | - | - | 38,0 | 112,5 | 97,0 | 117,0 | 102,0 | 113,5 | 91,0 | 40,6 | 134,0 | 103,6 | 134,0 | 103,6 | 134,0 | 103,6 | 34 | | | | | | | | |
| 38 | - | - | - | - | 31,0 | 109,0 | 93,0 | 115,0 | 97,8 | 106,6 | 86,5 | 33,2 | 126,3 | 98,6 | 126,3 | 98,6 | 126,3 | 98,6 | 38 | | | | | | | | |
| 42 | - | - | - | - | 25,0 | 105,0 | 89,0 | 111,0 | 93,5 | 100,0 | 82,5 | 26,7 | 119,0 | 94,0 | 119,0 | 94,0 | 119,0 | 94,0 | 42 | | | | | | | | |
| 46 | - | - | - | - | 20,2 | 100,3 | 85,3 | 107,0 | 89,8 | 95,3 | 78,8 | 21,6 | 113,0 | 90,0 | 113,0 | 90,0 | 113,0 | 90,0 | 46 | | | | | | | | |
| 50 | - | - | - | - | 15,9 | 94,0 | 81,6 | 103,0 | 86,3 | 90,8 | 75,5 | 17,0 | 107,3 | 86,3 | 107,3 | 86,3 | 107,3 | 86,3 | 50 | | | | | | | | |
| 54 | - | - | - | - | 12,1 | 87,0 | 78,0 | 99,0 | 83,0 | 86,5 | 72,5 | 13,0 | 102,0 | 83,0 | 102,0 | 83,0 | 102,0 | 83,0 | 54 | | | | | | | | |
| 58 | - | - | - | - | 8,5 | 82,3 | 74,6 | 94,1 | 79,5 | 82,6 | 69,7 | 9,2 | 98,0 | 80,0 | 98,0 | 80,0 | 98,0 | 80,0 | 58 | | | | | | | | |
| 62 | - | - | - | - | 5,1 | 78,0 | 71,5 | 90,0 | 76,5 | 79,3 | 67,1 | 5,6 | 94,0 | 77,3 | 94,0 | 77,2 | 94,0 | 77,3 | 62 | | | | | | | | |
| 64 | - | - | - | - | 3,6 | 74,2 | 70,2 | 88,0 | 75,0 | 77,6 | 65,8 | 4,0 | 92,0 | 76,1 | 92,0 | 76,0 | 92,0 | 75,9 | 64 | | | | | | | | |
| 66 | - | - | - | - | - | 72,5 | 69,0 | 86,0 | 73,5 | 76,0 | 64,5 | - | 90,0 | 74,5 | 90,0 | 74,5 | 90,0 | 74,5 | 66 | | | | | | | | |
| 70 | - | - | - | - | - | 69,8 | 65,0 | 82,0 | 71,1 | 73,0 | 62,5 | - | 86,6 | 72,5 | 86,6 | 72,5 | 86,6 | 72,5 | 70 | | | | | | | | |
| 74 | - | - | - | - | - | 66,3 | 62,8 | 77,8 | 69,0 | 70,3 | 60,6 | - | 83,5 | 70,5 | 83,3 | 70,5 | 82,6 | 70,5 | 74 | | | | | | | | |
| 78 | - | - | - | - | - | 64,0 | 60,5 | 73,5 | 67,0 | 68,0 | 59,0 | - | 80,5 | 68,5 | 80,0 | 68,5 | 79,0 | 68,5 | 78 | | | | | | | | |
| 82 | - | - | - | - | - | 61,8 | 58,8 | 68,1 | 65,0 | 64,3 | 57,3 | - | 74,8 | 66,5 | 74,3 | 66,5 | 73,3 | 66,5 | 82 | | | | | | | | |
| 86 | - | - | - | - | - | 60,3 | 57,3 | 63,1 | 62,0 | 60,1 | 55,7 | - | 69,5 | 64,8 | 69,0 | 64,8 | 68,0 | 64,6 | 86 | | | | | | | | |
| 90 | - | - | - | - | - | 59,0 | 56,0 | 58,5 | 58,0 | 55,5 | 54,5 | - | 64,5 | 63,5 | 64,0 | 63,5 | 63,0 | 63,0 | 90 | | | | | | | | |
| 94 | - | - | - | - | - | 55,0 | 54,2 | 53,9 | 54,0 | 51,3 | 50,3 | - | 60,0 | 60,0 | 59,5 | 59,7 | 58,6 | 58,6 | 94 | | | | | | | | |
| 98 | - | - | - | - | - | 51,2 | 51,2 | 48,6 | 49,6 | 47,3 | 46,3 | - | 55,6 | 55,8 | 55,1 | 55,3 | 54,3 | 54,3 | 98 | | | | | | | | |
| 102 | - | - | - | - | - | 47,6 | 47,8 | 42,9 | 44,8 | 43,5 | 42,3 | - | 51,0 | 51,5 | 50,5 | 51,0 | 50,0 | 50,0 | 102 | | | | | | | | |
| 106 | - | - | - | - | - | 44,4 | 44,5 | 37,4 | 38,4 | 39,9 | 38,8 | - | 47,4 | 47,7 | 46,9 | 47,2 | 46,2 | 46,6 | 106 | | | | | | | | |
| 110 | - | - | - | - | - | 41,3 | 41,4 | 32,4 | 33,6 | 36,6 | 35,5 | - | 44,0 | 44,5 | 43,5 | 44,0 | 42,8 | 43,3 | 110 | | | | | | | | |
| 114 | - | - | - | - | - | 38,5 | 38,6 | 28,0 | 27,7 | 33,5 | 32,5 | - | 40,8 | 41,5 | 40,4 | 41,1 | 39,7 | 40,4 | 114 | | | | | | | | |
| 116 | - | - | - | - | - | 37,2 | 37,3 | 25,3 | 19,9 | 32,1 | 31,1 | - | 39,5 | 40,3 | 39,1 | 39,9 | 38,3 | 39,2 | 116 | | | | | | | | |
| 117 | - | - | - | - | - | 36,5 | 17,8 | 23,9 | - | 31,5 | - | - | 38,9 | - | 38,5 | - | 37,7 | - | 117 | | | | | | | | |
| 118 | - | - | - | - | - | 35,9 | - | 22,6 | - | 30,8 | - | - | 38,2 | - | 37,8 | - | 37,1 | - | 118 | | | | | | | | |
| 120 | - | - | - | - | - | 34,7 | - | 20,5 | - | 29,5 | - | - | 37,0 | - | 36,6 | - | 35,9 | - | 120 | | | | | | | | |



| 165 t + 50 t | | 8,40 m | | 9.8 m/s | | 360° | | ISO | | | | | | | | | | | | | | | | | | | | | | | |
|--------------|------|--------|------|----------|------|-------|-------|----------|-------|-------|-------|----------|-------|-------|-------|----------|-------|-------|-------|-----------|-----|--|--|-----------|--|--|--|-----------|--|--|--|
| 126 m | | | | | | | | | | | | | | | | | | | | | | | | | | | | | | | |
| LSL+LF_2 | | | | LSL+LF_3 | | | | LSL+LF_4 | | | | LSL+LF_6 | | | | LSL+LF_8 | | | | LSL+LF_10 | | | | LSL+LF_12 | | | | LSL+LF_14 | | | |
| 12 m | | | | | | | | | | | | | | | | | | | | | | | | | | | | | | | |
| 0 t | | | | 0t-325t | | | | 0 t | | | | 0t-325t | | | | 0 t | | | | 0t-325t | | | | | | | | | | | |
| 15° | | | | 20° | | | | 30° | | | | 15° | | | | 20° | | | | 15° | | | | 20° | | | | | | | |
| m | t | t | t | t | t | t | t | t | t | t | t | t | t | t | t | t | t | t | t | t | m | | | | | | | | | | |
| 17 | 95,0 | 99,0 | - | - | - | - | - | 108,0 | - | 121,0 | - | 99,5 | 133,0 | - | 138,0 | - | 151,0 | - | 166,0 | - | 17 | | | | | | | | | | |
| 18 | 90,0 | 99,0 | 96,5 | - | 88,5 | 107,0 | 105,0 | 108,0 | 105,0 | 121,0 | 116,0 | 93,5 | 133,0 | 129,0 | 138,0 | 130,0 | 151,0 | 130,0 | 166,0 | 127,0 | 18 | | | | | | | | | | |
| 20 | 80,0 | 98,5 | 96,0 | 80,0 | 79,0 | 107,0 | 104,0 | 108,0 | 104,0 | 121,0 | 112,0 | 83,5 | 133,0 | 126,0 | 138,0 | 126,0 | 151,0 | 126,0 | 166,0 | 123,0 | 20 | | | | | | | | | | |
| 22 | 72,0 | 98,0 | 96,0 | 78,0 | 71,2 | 106,5 | 104,0 | 107,5 | 104,0 | 121,0 | 109,0 | 75,2 | 133,0 | 122,0 | 138,0 | 122,0 | 150,5 | 122,0 | 163,0 | 119,0 | 22 | | | | | | | | | | |
| 24 | 65,0 | 98,0 | 95,5 | 76,0 | 63,5 | 106,0 | 104,0 | 107,0 | 104,0 | 121,0 | 105,0 | 67,0 | 133,0 | 119,0 | 138,0 | 119,0 | 150,0 | 119,0 | 157,0 | 116,0 | 24 | | | | | | | | | | |
| 26 | 58,5 | 97,5 | 95,5 | 74,5 | 57,7 | 105,5 | 103,0 | 106,5 | 103,0 | 121,0 | 102,0 | 60,7 | 133,0 | 115,0 | 137,5 | 115,0 | 149,5 | 115,0 | 151,5 | 112,5 | 26 | | | | | | | | | | |
| 28 | 53,0 | 96,5 | 95,0 | 73,0 | 52,0 | 105,0 | 103,0 | 106,0 | 102,0 | 121,0 | 99,5 | 54,5 | 133,0 | 112,0 | 137,0 | 112,0 | 149,0 | 112,0 | 146,0 | 109,0 | 28 | | | | | | | | | | |
| 30 | 48,1 | 96,0 | 94,0 | 71,5 | 47,4 | 104,5 | 102,0 | 105,0 | 102,0 | 119,5 | 97,0 | 49,6 | 132,5 | 109,0 | 137,0 | 109,0 | 144,0 | 109,0 | 141,0 | 106,0 | 30 | | | | | | | | | | |
| 34 | 39,9 | 94,8 | 92,6 | 68,8 | 39,0 | 103,5 | 100,6 | 103,5 | 100,3 | 114,5 | 92,0 | 40,6 | 131,5 | 103,6 | 134,0 | 103,6 | 135,0 | 103,6 | 132,0 | 100,7 | 34 | | | | | | | | | | |
| 38 | 32,8 | 93,6 | 91,0 | 66,3 | 32,1 | 102,0 | 99,1 | 102,0 | 98,5 | 107,6 | 87,3 | 33,3 | 126,6 | 98,8 | 127,3 | 98,8 | 127,3 | 98,8 | 124,5 | 96,2 | 38 | | | | | | | | | | |
| 42 | 26,8 | 92,0 | 89,0 | 64,0 | 26,1 | 100,0 | 97,5 | 100,0 | 96,5 | 101,0 | 83,0 | 26,9 | 120,0 | 94,5 | 120,0 | 94,5 | 120,0 | 94,5 | 117,6 | 91,8 | 42 | | | | | | | | | | |
| 46 | 22,0 | 90,0 | 86,6 | 62,0 | 21,3 | 98,0 | 95,5 | 97,6 | 93,8 | 96,3 | 79,3 | 21,9 | 114,0 | 90,8 | 114,0 | 90,8 | 114,0 | 90,8 | 111,0 | 87,5 | 46 | | | | | | | | | | |
| 50 | 17,7 | 87,8 | 84,1 | 60,0 | 17,1 | 95,0 | 92,1 | 93,1 | 89,8 | 91,8 | 76,0 | 17,3 | 108,3 | 87,1 | 108,3 | 87,1 | 108,3 | 87,1 | 105,6 | 84,1 | 50 | | | | | | | | | | |
| 54 | 13,9 | 85,5 | 81,5 | 58,0 | 13,4 | 93,0 | 89,0 | 90,0 | 86,5 | 87,5 | 73,0 | 13,3 | 103,0 | 83,5 | 103,0 | 83,5 | 103,0 | 83,5 | 100,6 | 81,0 | 54 | | | | | | | | | | |
| 58 | 10,2 | 82,0 | 77,6 | 56,3 | 9,7 | 89,5 | 85,3 | 86,8 | 83,5 | 83,5 | 70,3 | 9,5 | 99,0 | 80,8 | 99,0 | 80,8 | 99,0 | 80,8 | 96,0 | 78,0 | 58 | | | | | | | | | | |
| 62 | 6,8 | 78,3 | 75,1 | 54,9 | 6,3 | 86,0 | 82,3 | 84,2 | 79,2 | 80,2 | 67,9 | 6,0 | 95,0 | 78,1 | 95,0 | 78,1 | 95,1 | 78,1 | 92,0 | 75,0 | 62 | | | | | | | | | | |
| 65 | 4,5 | 76,5 | 73,0 | 54,0 | 4,1 | 84,0 | 80,5 | 81,2 | 77,2 | 77,8 | 66,1 | 3,6 | 92,2 | 76,1 | 92,2 | 76,1 | 92,4 | 76,1 | 89,1 | 72,9 | 65 | | | | | | | | | | |
| 66 | 3,8 | 75,5 | 72,5 | 53,5 | - | 83,5 | 80,0 | 79,5 | 76,5 | 77,0 | 65,5 | - | 91,5 | 75,5 | 91,5 | 75,5 | 91,5 | 75,5 | 88,3 | 72,3 | 66 | | | | | | | | | | |
| 70 | - | 71,8 | 68,1 | 52,2 | - | 80,1 | 76,1 | 76,8 | 72,6 | 74,0 | 63,1 | - | 88,1 | 73,1 | 88,0 | 73,1 | 88,1 | 73,1 | 85,0 | 70,0 | 70 | | | | | | | | | | |
| 74 | - | 69,0 | 65,3 | 51,0 | - | 77,6 | 73,0 | 73,3 | 70,5 | 71,3 | 61,1 | - | 84,6 | 71,0 | 84,5 | 71,0 | 83,8 | 71,0 | 82,0 | 68,0 | 74 | | | | | | | | | | |
| 78 | - | 67,0 | 63,0 | 50,0 | - | 75,0 | 71,0 | 71,0 | 68,5 | 69,0 | 59,5 | - | 81,0 | 69,0 | 80,5 | 69,0 | 78,5 | 69,0 | 77,6 | 66,1 | 78 | | | | | | | | | | |
| 82 | - | 64,5 | 61,6 | 49,2 | - | 69,6 | 68,3 | 68,0 | 66,3 | 65,6 | 57,8 | - | 75,0 | 67,0 | 74,5 | 67,0 | 72,5 | 67,0 | 72,0 | 64,5 | 82 | | | | | | | | | | |
| 86 | - | 62,5 | 60,0 | 48,4 | - | 64,6 | 64,8 | 64,3 | 63,6 | 61,6 | 56,3 | - | 69,5 | 65,3 | 69,1 | 65,3 | 67,0 | 65,0 | 66,3 | 62,8 | 86 | | | | | | | | | | |
| 90 | - | 60,5 | 59,0 | 47,6 | - | 60,0 | 60,5 | 60,0 | 60,0 | 57,0 | 55,0 | - | 64,5 | 64,0 | 64,5 | 64,0 | 62,0 | 62,5 | 61,1 | 60,5 | 90 | | | | | | | | | | |
| 94 | - | 56,5 | 56,2 | 46,9 | - | 56,0 | 56,1 | 56,0 | 56,0 | 52,6 | 52,0 | - | 60,0 | 60,5 | 60,0 | 60,0 | 57,6 | 57,8 | 56,5 | 56,5 | 94 | | | | | | | | | | |
| 98 | - | 52,7 | 52,7 | 46,3 | - | 52,2 | 52,6 | 52,2 | 52,2 | 48,7 | 48,6 | - | 55,8 | 56,3 | 55,8 | 55,8 | 53,5 | 53,5 | 52,1 | 52,1 | 98 | | | | | | | | | | |
| 102 | - | 49,1 | 49,3 | 45,8 | - | 48,8 | 49,0 | 48,6 | 48,8 | 45,2 | 44,9 | - | 51,5 | 52,0 | 51,5 | 51,5 | 49,5 | 49,6 | 47,9 | 48,0 | 102 | | | | | | | | | | |
| 105 | - | 46,7 | 46,8 | 36,4 | - | 46,4 | 46,5 | 46,2 | 46,3 | 42,7 | 42,2 | - | 48,7 | 49,2 | 48,6 | 48,8 | 46,6 | 46,8 | 44,9 | 45,0 | 105 | | | | | | | | | | |
| 106 | - | 45,9 | 46,0 | - | - | 45,6 | 45,7 | 45,4 | 45,5 | 41,9 | 41,3 | - | 47,8 | 48,2 | 47,7 | 47,9 | 45,6 | 45,8 | 43,9 | 44,0 | 106 | | | | | | | | | | |
| 110 | - | 42,8 | 42,9 | - | - | 42,5 | 42,5 | 42,3 | 42,4 | 38,8 | 38,0 | - | 44,3 | 44,8 | 44,2 | 44,6 | 42,0 | 42,4 | 40,3 | 40,4 | 110 | | | | | | | | | | |
| 114 | - | 40,0 | 40,1 | - | - | 39,7 | 39,4 | 39,5 | 39,6 | 36,0 | 35,0 | - | 41,1 | 41,7 | 41,0 | 41,5 | 38,8 | 39,4 | 37,0 | 37,1 | 114 | | | | | | | | | | |
| 118 | - | 37,4 | 37,5 | - | - | 35,9 | 35,6 | 36,9 | 37,0 | 33,2 | 32,2 | - | 38,4 | 39,1 | 38,3 | 39,0 | 36,2 | 36,9 | 33,8 | 34,0 | 118 | | | | | | | | | | |
| 119 | - | 36,8 | 36,9 | - | - | 34,9 | - | 36,3 | 36,4 | 32,5 | - | - | 37,7 | - | 37,6 | - | 35,5 | - | 33,1 | - | 119 | | | | | | | | | | |
| 122 | - | 35,0 | - | - | - | 31,8 | - | 34,6 | - | 30,6 | - | - | 36,0 | - | 35,8 | - | 33,8 | - | 31,1 | - | 122 | | | | | | | | | | |

 0t
 65t
 95t
 125t
 165t
 205t
 265t
 325t

LSL+LF_14:  225 t +  50 t

| 165 t + 50 t | | 8,40 m | | 9.8 m/s | | 360° | | ISO | | | | | | | | | | | | | | | | | | | | | | | | | | | | | | | |
|--------------|---|--------|---|---------|-----------|-------|-------|-------|-------|----------|-------|------|-------|-------|-----------|-------|-------|-------|-------|----------|-----|---|---|-----|-----------|---|---|-----|---|-----------|--|-----|--|--|-----------|--|--|--|--|
| 129 m | | | | | | | | | | | | | | | | | | | | | | | | | | | | | | | | | | | | | | | |
| LSL+LF_2 | | | | | LSL+LF_3 | | | | | LSL+LF_4 | | | | | LSL+LF_6 | | | | | LSL+LF_8 | | | | | LSL+LF_10 | | | | | LSL+LF_12 | | | | | LSL+LF_14 | | | | |
| 12 m | | | | | | | | | | | | | | | | | | | | | | | | | | | | | | | | | | | | | | | |
| 0 t | | | | | 0 t-325 t | | | | | 0 t | | | | | 0 t-325 t | | | | | 0 t | | | | | 0 t-325 t | | | | | | | | | | | | | | |
| 15° | | | | 20° | | | | 30° | | | | 15° | | | | 20° | | | | 15° | | | | 20° | | | | 15° | | | | 20° | | | | | | | |
| m | t | t | t | t | t | t | t | t | t | t | t | t | t | t | t | t | t | t | t | t | t | t | t | t | t | t | t | t | t | m | | | | | | | | | |
| 17 | - | - | - | - | - | - | - | 103,0 | - | 116,0 | - | 97,0 | 128,0 | - | 133,0 | - | 145,0 | - | 160,0 | - | 17 | | | | | | | | | | | | | | | | | | |
| 18 | - | - | - | - | 86,5 | 102,0 | 101,0 | 103,0 | 100,0 | 116,0 | 113,0 | 91,5 | 128,0 | 124,0 | 133,0 | 129,0 | 145,0 | 130,0 | 160,0 | 128,0 | 18 | | | | | | | | | | | | | | | | | | |
| 20 | - | - | - | - | 77,0 | 102,0 | 100,0 | 103,0 | 100,0 | 115,0 | 113,0 | 81,5 | 128,0 | 124,0 | 133,0 | 126,0 | 145,0 | 126,0 | 160,0 | 124,0 | 20 | | | | | | | | | | | | | | | | | | |
| 22 | - | - | - | - | 69,5 | 101,5 | 100,0 | 102,5 | 100,0 | 115,0 | 109,0 | 73,2 | 128,0 | 123,0 | 133,0 | 123,0 | 145,0 | 123,0 | 160,0 | 120,0 | 22 | | | | | | | | | | | | | | | | | | |
| 24 | - | - | - | - | 62,0 | 101,0 | 100,0 | 102,0 | 100,0 | 115,0 | 106,0 | 65,0 | 128,0 | 119,0 | 133,0 | 119,0 | 145,0 | 119,0 | 158,0 | 116,0 | 24 | | | | | | | | | | | | | | | | | | |
| 26 | - | - | - | - | 56,2 | 101,0 | 100,0 | 101,5 | 100,0 | 115,0 | 103,0 | 59,0 | 128,0 | 116,0 | 132,5 | 116,0 | 144,5 | 116,0 | 152,5 | 113,0 | 26 | | | | | | | | | | | | | | | | | | |
| 28 | - | - | - | - | 50,5 | 101,0 | 99,5 | 101,0 | 99,5 | 115,0 | 100,0 | 53,0 | 128,0 | 113,0 | 132,0 | 113,0 | 144,0 | 113,0 | 147,0 | 110,0 | 28 | | | | | | | | | | | | | | | | | | |
| 30 | - | - | - | - | 45,8 | 100,5 | 99,0 | 101,0 | 99,0 | 114,5 | 97,5 | 48,0 | 127,5 | 110,0 | 132,0 | 110,0 | 142,0 | 110,0 | 142,5 | 107,0 | 30 | | | | | | | | | | | | | | | | | | |
| 34 | - | - | - | - | 37,4 | 99,2 | 97,6 | 100,5 | 97,3 | 113,0 | 92,5 | 39,0 | 126,5 | 104,6 | 131,0 | 104,6 | 136,0 | 104,6 | 133,5 | 101,5 | 34 | | | | | | | | | | | | | | | | | | |
| 38 | - | - | - | - | 30,7 | 98,5 | 96,3 | 99,3 | 95,8 | 108,6 | 88,0 | 31,8 | 123,6 | 99,8 | 127,0 | 99,8 | 128,3 | 99,8 | 125,5 | 96,7 | 38 | | | | | | | | | | | | | | | | | | |
| 42 | - | - | - | - | 24,7 | 97,5 | 95,0 | 98,0 | 94,5 | 102,0 | 84,0 | 25,4 | 121,0 | 95,5 | 121,0 | 95,5 | 121,0 | 95,5 | 118,6 | 92,5 | 42 | | | | | | | | | | | | | | | | | | |
| 46 | - | - | - | - | 20,0 | 95,8 | 93,3 | 96,0 | 92,5 | 97,3 | 80,3 | 20,4 | 114,3 | 91,5 | 115,0 | 91,5 | 115,0 | 91,5 | 112,0 | 88,5 | 46 | | | | | | | | | | | | | | | | | | |
| 50 | - | - | - | - | 15,8 | 93,1 | 90,6 | 92,5 | 89,5 | 92,8 | 76,8 | 15,9 | 109,6 | 87,8 | 109,6 | 87,8 | 109,6 | 87,8 | 106,6 | 84,8 | 50 | | | | | | | | | | | | | | | | | | |
| 54 | - | - | - | - | 12,0 | 91,5 | 89,0 | 90,5 | 87,5 | 88,5 | 73,5 | 11,9 | 105,0 | 84,5 | 105,0 | 84,5 | 105,0 | 84,5 | 101,6 | 81,5 | 54 | | | | | | | | | | | | | | | | | | |
| 58 | - | - | - | - | 8,5 | 88,5 | 86,3 | 87,5 | 83,6 | 84,5 | 71,0 | 8,3 | 100,3 | 81,5 | 100,3 | 81,5 | 100,3 | 81,5 | 97,0 | 78,5 | 58 | | | | | | | | | | | | | | | | | | |
| 62 | - | - | - | - | 5,2 | 85,8 | 84,5 | 85,5 | 81,1 | 81,0 | 68,3 | 4,8 | 96,0 | 78,7 | 96,0 | 78,6 | 96,1 | 78,6 | 93,0 | 75,5 | 62 | | | | | | | | | | | | | | | | | | |
| 63 | - | - | - | - | 4,4 | 85,5 | 84,0 | 84,0 | 80,5 | 80,2 | 67,7 | 4,0 | 95,0 | 78,1 | 95,1 | 78,0 | 95,2 | 78,0 | 92,0 | 75,0 | 63 | | | | | | | | | | | | | | | | | | |
| 64 | - | - | - | - | 3,7 | 85,0 | 82,3 | 83,5 | 79,8 | 79,5 | 67,1 | - | 94,1 | 77,5 | 94,2 | 77,3 | 94,3 | 77,3 | 91,0 | 74,5 | 64 | | | | | | | | | | | | | | | | | | |
| 66 | - | - | - | - | - | 84,0 | 80,5 | 82,5 | 78,5 | 78,0 | 66,0 | - | 92,5 | 76,0 | 92,5 | 76,0 | 92,5 | 76,0 | 89,3 | 73,3 | 66 | | | | | | | | | | | | | | | | | | |
| 70 | - | - | - | - | - | 81,0 | 77,8 | 79,1 | 75,6 | 75,0 | 64,0 | - | 89,1 | 73,6 | 89,1 | 73,6 | 89,1 | 73,6 | 86,0 | 71,0 | 70 | | | | | | | | | | | | | | | | | | |
| 74 | - | - | - | - | - | 78,0 | 75,5 | 76,6 | 72,6 | 72,1 | 62,0 | - | 85,0 | 71,5 | 84,8 | 71,5 | 84,1 | 71,5 | 82,0 | 68,6 | 74 | | | | | | | | | | | | | | | | | | |
| 78 | - | - | - | - | - | 74,0 | 73,5 | 74,0 | 71,0 | 69,5 | 60,0 | - | 80,0 | 69,5 | 79,5 | 69,5 | 77,5 | 69,5 | 76,6 | 66,6 | 78 | | | | | | | | | | | | | | | | | | |
| 82 | - | - | - | - | - | 68,6 | 68,8 | 68,6 | 67,6 | 65,1 | 58,3 | - | 74,0 | 67,8 | 73,5 | 67,8 | 71,5 | 67,8 | 70,0 | 65,0 | 82 | | | | | | | | | | | | | | | | | | |
| 86 | - | - | - | - | - | 63,6 | 64,1 | 63,6 | 63,6 | 60,4 | 56,7 | - | 68,5 | 66,0 | 68,0 | 65,8 | 66,0 | 66,0 | 64,5 | 63,4 | 86 | | | | | | | | | | | | | | | | | | |
| 90 | - | - | - | - | - | 59,0 | 59,5 | 59,0 | 59,0 | 56,0 | 55,5 | - | 63,5 | 64,0 | 63,0 | 63,5 | 61,0 | 61,0 | 59,1 | 60,0 | 90 | | | | | | | | | | | | | | | | | | |
| 94 | - | - | - | - | - | 55,0 | 55,2 | 55,0 | 55,0 | 51,7 | 51,4 | - | 59,2 | 59,2 | 58,6 | 59,2 | 56,3 | 56,6 | 54,5 | 55,0 | 94 | | | | | | | | | | | | | | | | | | |
| 98 | - | - | - | - | - | 51,2 | 51,6 | 51,2 | 51,2 | 47,7 | 47,3 | - | 54,6 | 54,8 | 54,3 | 54,6 | 52,0 | 52,1 | 50,0 | 50,0 | 98 | | | | | | | | | | | | | | | | | | |
| 102 | - | - | - | - | - | 47,7 | 47,9 | 47,6 | 47,8 | 44,1 | 43,5 | - | 50,0 | 50,5 | 50,0 | 50,0 | 47,9 | 48,0 | 46,1 | 46,3 | 102 | | | | | | | | | | | | | | | | | | |
| 106 | - | - | - | - | - | 44,4 | 44,6 | 44,3 | 44,5 | 40,8 | 39,9 | - | 46,4 | 46,6 | 46,2 | 46,4 | 44,0 | 44,2 | 42,1 | 42,3 | 106 | | | | | | | | | | | | | | | | | | |
| 110 | - | - | - | - | - | 41,3 | 41,0 | 41,3 | 41,4 | 37,6 | 36,5 | - | 42,9 | 43,2 | 42,6 | 43,0 | 40,3 | 40,6 | 38,5 | 38,6 | 110 | | | | | | | | | | | | | | | | | | |
| 114 | - | - | - | - | - | 38,5 | 37,2 | 38,5 | 38,6 | 34,5 | 33,5 | - | 39,5 | 40,0 | 39,3 | 39,8 | 37,1 | 37,5 | 35,2 | 35,3 | 114 | | | | | | | | | | | | | | | | | | |
| 118 | - | - | - | - | - | 34,9 | 32,5 | 35,9 | 35,8 | 31,7 | 30,7 | - | 36,6 | 37,3 | 36,4 | 37,1 | 34,3 | 34,9 | 32,0 | 32,2 | 118 | | | | | | | | | | | | | | | | | | |
| 121 | - | - | - | - | - | 31,3 | 20,6 | 34,1 | 33,9 | 29,7 | 28,8 | - | 34,8 | 35,5 | 34,5 | 35,3 | 32,3 | 33,2 | 29,9 | 30,1 | 121 | | | | | | | | | | | | | | | | | | |
| 122 | - | - | - | - | - | 30,0 | - | 33,5 | - | 29,1 | - | - | 34,2 | - | 33,9 | - | 31,8 | - | 29,2 | - | 122 | | | | | | | | | | | | | | | | | | |
| 125 | - | - | - | - | - | 26,1 | - | 31,9 | - | 27,3 | - | - | 32,5 | - | 32,3 | - | 30,2 | - | 27,3 | - | 125 | | | | | | | | | | | | | | | | | | |



LSL+LF_14: 225 t + 50 t

| 165 t + 50 t | | 8,40 m | | 9.8 m/s | | 360° | | ISO | | | | | | | | | | | | | | | | | | | | | | | |
|--------------|------|--------|------|----------|------|------|------|----------|------|-------|-------|----------|-------|-------|-------|----------|-------|-------|-------|-----------|-----|--|--|-----------|--|--|--|-----------|--|--|--|
| 132 m | | | | | | | | | | | | | | | | | | | | | | | | | | | | | | | |
| LSL+LF_2 | | | | LSL+LF_3 | | | | LSL+LF_4 | | | | LSL+LF_6 | | | | LSL+LF_8 | | | | LSL+LF_10 | | | | LSL+LF_12 | | | | LSL+LF_14 | | | |
| 12 m | | | | | | | | | | | | | | | | | | | | | | | | | | | | | | | |
| 0 t | | | | 0t-325t | | | | 0 t | | | | 0t-325t | | | | 0 t | | | | 0t-325t | | | | | | | | | | | |
| 15° | | | | 20° | | | | 30° | | | | 15° | | | | 20° | | | | 15° | | | | 20° | | | | | | | |
| m | t | t | t | t | t | t | t | t | t | t | t | t | t | t | t | t | t | t | t | t | m | | | | | | | | | | |
| 17 | 84,0 | 87,0 | - | - | - | - | - | - | - | - | - | - | - | - | - | - | - | - | - | - | 17 | | | | | | | | | | |
| 18 | 84,0 | 86,5 | 85,0 | - | 84,5 | 98,5 | 96,5 | 99,0 | 96,5 | 109,0 | 107,0 | 89,5 | 123,0 | - | 127,0 | - | 140,0 | - | 154,0 | - | 18 | | | | | | | | | | |
| 19 | 80,2 | 86,5 | 84,7 | - | 80,0 | 98,2 | 96,2 | 98,7 | 96,5 | 109,0 | 107,0 | 84,5 | 123,0 | 119,0 | 127,0 | 124,0 | 140,0 | 129,0 | 154,0 | 126,0 | 19 | | | | | | | | | | |
| 20 | 77,0 | 86,5 | 84,5 | 77,0 | 75,5 | 98,0 | 96,0 | 98,5 | 96,5 | 109,0 | 107,0 | 79,5 | 123,0 | 119,0 | 127,0 | 124,0 | 140,0 | 127,0 | 154,0 | 124,0 | 20 | | | | | | | | | | |
| 22 | 69,0 | 86,0 | 84,0 | 76,5 | 68,0 | 97,7 | 96,0 | 98,2 | 96,0 | 109,0 | 107,0 | 71,5 | 123,0 | 119,0 | 127,0 | 123,0 | 140,0 | 123,0 | 154,0 | 120,0 | 22 | | | | | | | | | | |
| 24 | 62,0 | 85,5 | 84,0 | 76,5 | 60,5 | 97,5 | 95,5 | 98,0 | 95,5 | 109,0 | 106,0 | 63,5 | 123,0 | 119,0 | 127,0 | 120,0 | 140,0 | 120,0 | 154,0 | 117,0 | 24 | | | | | | | | | | |
| 26 | 56,0 | 85,0 | 83,5 | 75,0 | 54,8 | 97,2 | 95,0 | 97,5 | 95,0 | 108,5 | 103,0 | 57,5 | 122,0 | 116,0 | 127,0 | 116,0 | 139,0 | 116,0 | 151,0 | 113,5 | 26 | | | | | | | | | | |
| 28 | 50,5 | 84,0 | 82,5 | 73,5 | 49,2 | 97,0 | 94,5 | 97,5 | 95,0 | 108,0 | 100,0 | 51,5 | 122,0 | 113,0 | 127,0 | 113,0 | 138,0 | 113,0 | 148,0 | 110,0 | 28 | | | | | | | | | | |
| 30 | 46,0 | 83,5 | 82,0 | 72,0 | 44,6 | 96,5 | 94,0 | 97,0 | 94,5 | 108,0 | 98,0 | 46,7 | 121,5 | 110,0 | 127,0 | 110,0 | 138,0 | 110,0 | 143,5 | 107,5 | 30 | | | | | | | | | | |
| 34 | 38,0 | 82,5 | 81,0 | 69,3 | 36,3 | 95,2 | 93,0 | 96,0 | 93,1 | 107,5 | 93,0 | 37,9 | 120,5 | 105,3 | 126,0 | 105,3 | 135,5 | 105,3 | 134,5 | 102,5 | 34 | | | | | | | | | | |
| 38 | 31,1 | 81,6 | 80,0 | 66,8 | 29,6 | 93,8 | 91,6 | 94,8 | 91,8 | 105,6 | 88,5 | 30,7 | 119,0 | 100,6 | 123,0 | 100,6 | 129,3 | 100,6 | 126,5 | 97,5 | 38 | | | | | | | | | | |
| 42 | 25,1 | 81,0 | 79,0 | 64,5 | 23,7 | 92,5 | 90,0 | 93,5 | 90,5 | 103,0 | 84,5 | 24,4 | 117,0 | 96,0 | 119,0 | 96,0 | 122,0 | 96,0 | 119,6 | 93,0 | 42 | | | | | | | | | | |
| 46 | 20,4 | 79,3 | 77,3 | 62,5 | 19,0 | 90,5 | 87,6 | 91,8 | 88,8 | 98,3 | 80,8 | 19,4 | 112,3 | 92,3 | 115,0 | 92,3 | 116,0 | 92,3 | 113,0 | 89,0 | 46 | | | | | | | | | | |
| 50 | 16,2 | 77,6 | 75,8 | 60,5 | 14,8 | 88,1 | 85,5 | 89,1 | 86,0 | 93,8 | 77,5 | 14,9 | 108,6 | 88,6 | 110,0 | 88,6 | 110,6 | 88,6 | 107,6 | 85,6 | 50 | | | | | | | | | | |
| 54 | 12,4 | 76,0 | 74,5 | 58,5 | 11,1 | 85,5 | 83,5 | 87,5 | 84,0 | 89,5 | 74,5 | 10,9 | 106,0 | 85,0 | 106,0 | 85,0 | 106,0 | 85,0 | 102,8 | 82,3 | 54 | | | | | | | | | | |
| 58 | 9,0 | 74,3 | 72,8 | 57,1 | 7,7 | 82,8 | 79,6 | 84,5 | 81,0 | 85,5 | 71,5 | 7,5 | 101,3 | 82,0 | 101,3 | 82,0 | 101,2 | 82,2 | 98,5 | 79,0 | 58 | | | | | | | | | | |
| 62 | 5,7 | 71,5 | 70,0 | 55,7 | 4,5 | 80,5 | 77,5 | 82,0 | 79,0 | 81,8 | 68,8 | 4,1 | 97,5 | 79,5 | 97,5 | 79,5 | 97,5 | 79,3 | 94,1 | 76,3 | 62 | | | | | | | | | | |
| 63 | 4,9 | 71,0 | 69,5 | 55,3 | 3,7 | 79,8 | 75,7 | 81,1 | 78,5 | 81,0 | 68,2 | - | 96,5 | 78,8 | 96,5 | 78,8 | 96,5 | 78,7 | 93,3 | 75,6 | 63 | | | | | | | | | | |
| 64 | 4,1 | 70,5 | 69,0 | 55,0 | - | 79,2 | 74,7 | 80,7 | 78,0 | 80,1 | 67,6 | - | 95,5 | 78,2 | 95,5 | 78,2 | 95,5 | 78,1 | 92,5 | 75,0 | 64 | | | | | | | | | | |
| 66 | - | 69,5 | 68,0 | 54,0 | - | 78,0 | 73,5 | 80,0 | 77,0 | 78,5 | 66,5 | - | 93,5 | 77,0 | 93,5 | 77,0 | 93,5 | 77,0 | 90,6 | 73,8 | 66 | | | | | | | | | | |
| 70 | - | 66,8 | 65,0 | 53,0 | - | 74,6 | 70,5 | 77,0 | 73,5 | 75,8 | 64,5 | - | 90,1 | 74,6 | 90,1 | 74,6 | 89,1 | 74,6 | 87,0 | 71,5 | 70 | | | | | | | | | | |
| 74 | - | 64,3 | 63,0 | 51,8 | - | 71,5 | 68,3 | 74,5 | 70,6 | 73,1 | 62,5 | - | 85,3 | 72,3 | 85,3 | 72,3 | 83,5 | 72,3 | 81,6 | 69,5 | 74 | | | | | | | | | | |
| 78 | - | 62,5 | 61,0 | 50,5 | - | 69,5 | 66,0 | 72,5 | 69,0 | 70,5 | 60,5 | - | 79,0 | 70,0 | 79,0 | 70,0 | 76,5 | 70,0 | 75,6 | 67,5 | 78 | | | | | | | | | | |
| 82 | - | 60,8 | 58,8 | 49,7 | - | 66,8 | 63,5 | 67,5 | 66,6 | 64,9 | 58,8 | - | 73,3 | 68,3 | 73,0 | 68,3 | 70,8 | 68,3 | 69,0 | 65,5 | 82 | | | | | | | | | | |
| 86 | - | 59,5 | 57,3 | 48,9 | - | 63,1 | 61,0 | 62,6 | 63,1 | 59,6 | 56,8 | - | 68,0 | 66,0 | 67,6 | 66,0 | 65,3 | 65,7 | 63,3 | 64,0 | 86 | | | | | | | | | | |
| 90 | - | 58,5 | 56,0 | 48,1 | - | 58,5 | 58,0 | 58,0 | 58,5 | 55,0 | 54,5 | - | 63,0 | 63,0 | 62,5 | 63,0 | 60,5 | 60,5 | 58,1 | 59,3 | 90 | | | | | | | | | | |
| 94 | - | 55,2 | 54,8 | 47,3 | - | 54,5 | 53,4 | 54,0 | 54,5 | 50,7 | 50,4 | - | 58,3 | 58,3 | 58,1 | 58,3 | 55,8 | 55,8 | 53,5 | 54,0 | 94 | | | | | | | | | | |
| 98 | - | 51,6 | 51,7 | 46,7 | - | 50,6 | 48,6 | 50,2 | 50,6 | 46,8 | 46,4 | - | 53,8 | 53,8 | 53,7 | 53,8 | 51,4 | 51,4 | 49,0 | 49,4 | 98 | | | | | | | | | | |
| 102 | - | 47,9 | 48,1 | 46,1 | - | 46,9 | 43,8 | 46,7 | 46,9 | 43,2 | 42,5 | - | 49,4 | 49,6 | 49,3 | 49,4 | 47,1 | 47,1 | 45,0 | 45,4 | 102 | | | | | | | | | | |
| 106 | - | 44,6 | 44,8 | 44,3 | - | 43,1 | 38,9 | 43,4 | 43,6 | 39,9 | 39,0 | - | 45,4 | 45,6 | 45,3 | 45,5 | 43,1 | 43,3 | 41,1 | 41,4 | 106 | | | | | | | | | | |
| 110 | - | 41,5 | 41,7 | 26,8 | - | 38,7 | 34,2 | 40,3 | 40,5 | 36,7 | 35,7 | - | 41,8 | 42,1 | 41,6 | 41,9 | 39,4 | 39,6 | 37,5 | 37,8 | 110 | | | | | | | | | | |
| 114 | - | 38,7 | 38,9 | - | - | 33,6 | 29,3 | 37,5 | 37,6 | 33,6 | 32,5 | - | 38,5 | 38,8 | 38,3 | 38,7 | 36,1 | 36,5 | 34,2 | 34,4 | 114 | | | | | | | | | | |
| 118 | - | 36,1 | 36,3 | - | - | 28,4 | 24,4 | 34,9 | 34,8 | 30,7 | 29,7 | - | 35,5 | 36,0 | 35,4 | 35,9 | 33,2 | 33,8 | 31,1 | 31,2 | 118 | | | | | | | | | | |
| 122 | - | 33,7 | 33,8 | - | - | 23,3 | 19,5 | 32,6 | 32,1 | 28,0 | 27,1 | - | 32,9 | 33,5 | 32,8 | 33,4 | 30,6 | 31,3 | 28,2 | 28,4 | 122 | | | | | | | | | | |
| 123 | - | 33,2 | 33,2 | - | - | 22,0 | 18,2 | 32,0 | 31,5 | 27,4 | 26,5 | - | 32,3 | 33,0 | 32,2 | 32,9 | 30,0 | 30,8 | 27,5 | 27,7 | 123 | | | | | | | | | | |
| 124 | - | 32,6 | 32,7 | - | - | 20,7 | - | 31,5 | 30,9 | 26,8 | - | - | 31,7 | - | 31,6 | - | 29,4 | - | 26,9 | - | 124 | | | | | | | | | | |
| 125 | - | 32,0 | 14,5 | - | - | 19,4 | - | 30,9 | - | 26,2 | - | - | 31,1 | - | 31,0 | - | 28,9 | - | 26,2 | - | 125 | | | | | | | | | | |
| 126 | - | 31,5 | - | - | - | 18,2 | - | 30,4 | - | 25,6 | - | - | 30,6 | - | 30,5 | - | 28,4 | - | 25,6 | - | 126 | | | | | | | | | | |
| 128 | - | 30,5 | - | - | - | 15,6 | - | 29,3 | - | 24,5 | - | - | 29,6 | - | 29,5 | - | 27,4 | - | 24,4 | - | 128 | | | | | | | | | | |

0t 65t 95t 125t 165t 205t 265t 325t

LSL+LF_14: 225t + 50t

| 165 t + 50 t | | 8,40 m | | 9.8 m/s | | 360° | | ISO | | | | | | | | | | | | | | | | | | | | | | | | | | | | | | | |
|--------------|---|--------|---|---------|-----------|------|------|------|------|----------|-------|------|-------|-------|-----------|-------|-------|-------|-------|----------|-----|--|--|-----|-----------|--|--|-----|--|-----------|--|-----|--|--|-----------|--|--|--|--|
| 135 m | | | | | | | | | | | | | | | | | | | | | | | | | | | | | | | | | | | | | | | |
| LSL+LF_2 | | | | | LSL+LF_3 | | | | | LSL+LF_4 | | | | | LSL+LF_6 | | | | | LSL+LF_8 | | | | | LSL+LF_10 | | | | | LSL+LF_12 | | | | | LSL+LF_14 | | | | |
| 12 m | | | | | | | | | | | | | | | | | | | | | | | | | | | | | | | | | | | | | | | |
| 0 t | | | | | 0 t-325 t | | | | | 0 t | | | | | 0 t-325 t | | | | | 0 t | | | | | 0 t-325 t | | | | | | | | | | | | | | |
| 15° | | | | 20° | | | | 30° | | | | 15° | | | | 20° | | | | 15° | | | | 20° | | | | 15° | | | | 20° | | | | | | | |
| m | t | t | t | t | t | t | t | t | t | t | t | t | t | t | t | t | t | t | t | t | m | | | | | | | | | | | | | | | | | | |
| 18 | - | - | - | - | - | - | - | 94,5 | - | 103,0 | - | 87,0 | 117,0 | - | 122,0 | - | 134,0 | - | 147,0 | - | 18 | | | | | | | | | | | | | | | | | | |
| 19 | - | - | - | - | 77,5 | 93,5 | 92,5 | 94,5 | 92,0 | 103,0 | 101,0 | 82,2 | 117,0 | 114,0 | 122,0 | 119,0 | 134,0 | 129,0 | 147,0 | 127,0 | 19 | | | | | | | | | | | | | | | | | | |
| 20 | - | - | - | - | 73,5 | 93,5 | 92,5 | 94,5 | 92,0 | 103,0 | 101,0 | 77,5 | 117,0 | 114,0 | 122,0 | 119,0 | 134,0 | 127,0 | 147,0 | 125,0 | 20 | | | | | | | | | | | | | | | | | | |
| 22 | - | - | - | - | 66,0 | 93,5 | 92,0 | 94,2 | 91,5 | 102,5 | 101,0 | 69,7 | 117,0 | 114,0 | 122,0 | 119,0 | 134,0 | 124,0 | 147,0 | 121,0 | 22 | | | | | | | | | | | | | | | | | | |
| 24 | - | - | - | - | 58,5 | 93,5 | 92,0 | 94,0 | 91,5 | 102,0 | 101,0 | 62,0 | 117,0 | 114,0 | 122,0 | 119,0 | 134,0 | 120,0 | 147,0 | 117,0 | 24 | | | | | | | | | | | | | | | | | | |
| 26 | - | - | - | - | 53,0 | 93,0 | 91,5 | 93,7 | 91,0 | 102,0 | 101,0 | 55,9 | 116,5 | 114,0 | 121,5 | 117,0 | 133,5 | 117,0 | 147,0 | 114,0 | 26 | | | | | | | | | | | | | | | | | | |
| 28 | - | - | - | - | 47,5 | 92,5 | 91,0 | 93,5 | 90,5 | 102,0 | 101,0 | 49,9 | 116,0 | 114,0 | 121,0 | 114,0 | 133,0 | 114,0 | 147,0 | 111,0 | 28 | | | | | | | | | | | | | | | | | | |
| 30 | - | - | - | - | 42,9 | 92,0 | 90,5 | 93,0 | 90,5 | 101,5 | 98,5 | 45,0 | 116,0 | 111,0 | 121,0 | 111,0 | 133,0 | 111,0 | 143,5 | 108,0 | 30 | | | | | | | | | | | | | | | | | | |
| 34 | - | - | - | - | 34,7 | 91,0 | 89,5 | 92,0 | 89,5 | 100,5 | 93,8 | 36,2 | 115,0 | 105,6 | 120,0 | 105,6 | 132,0 | 105,6 | 136,0 | 102,5 | 34 | | | | | | | | | | | | | | | | | | |
| 38 | - | - | - | - | 28,1 | 90,1 | 88,5 | 91,1 | 88,6 | 99,8 | 89,3 | 29,1 | 113,3 | 101,0 | 118,0 | 101,0 | 129,3 | 101,0 | 128,0 | 98,0 | 38 | | | | | | | | | | | | | | | | | | |
| 42 | - | - | - | - | 22,2 | 89,5 | 87,5 | 90,5 | 88,0 | 99,5 | 85,0 | 22,9 | 112,0 | 97,0 | 116,0 | 97,0 | 124,0 | 97,0 | 120,6 | 94,0 | 42 | | | | | | | | | | | | | | | | | | |
| 46 | - | - | - | - | 17,6 | 87,8 | 86,1 | 89,1 | 86,3 | 97,5 | 81,3 | 17,9 | 107,6 | 93,0 | 112,0 | 93,0 | 118,0 | 93,0 | 114,0 | 90,0 | 46 | | | | | | | | | | | | | | | | | | |
| 50 | - | - | - | - | 13,4 | 86,1 | 84,6 | 87,1 | 84,1 | 94,5 | 78,0 | 13,5 | 105,0 | 89,3 | 108,6 | 89,3 | 112,3 | 89,3 | 108,6 | 86,3 | 50 | | | | | | | | | | | | | | | | | | |
| 54 | - | - | - | - | 9,7 | 84,5 | 83,0 | 85,5 | 82,5 | 90,5 | 75,0 | 9,5 | 103,0 | 86,0 | 106,0 | 86,0 | 107,0 | 86,0 | 103,8 | 83,0 | 54 | | | | | | | | | | | | | | | | | | |
| 58 | - | - | - | - | 6,5 | 82,4 | 80,3 | 83,1 | 80,1 | 86,5 | 72,3 | 6,2 | 99,0 | 83,0 | 102,0 | 83,0 | 102,0 | 83,0 | 99,5 | 80,0 | 58 | | | | | | | | | | | | | | | | | | |
| 61 | - | - | - | - | 4,2 | 80,4 | 77,8 | 81,5 | 79,0 | 83,6 | 70,3 | 3,8 | 96,8 | 80,8 | 99,0 | 80,8 | 99,0 | 80,8 | 96,5 | 77,8 | 61 | | | | | | | | | | | | | | | | | | |
| 62 | - | - | - | - | - | 79,8 | 77,1 | 80,6 | 78,3 | 82,8 | 69,6 | - | 95,9 | 80,1 | 98,1 | 80,1 | 98,1 | 80,1 | 95,5 | 77,2 | 62 | | | | | | | | | | | | | | | | | | |
| 66 | - | - | - | - | - | 78,0 | 75,5 | 79,0 | 76,5 | 79,5 | 67,0 | - | 93,5 | 77,5 | 94,5 | 77,5 | 94,5 | 77,5 | 91,6 | 74,6 | 66 | | | | | | | | | | | | | | | | | | |
| 70 | - | - | - | - | - | 74,3 | 72,0 | 76,8 | 74,5 | 76,5 | 65,0 | - | 89,8 | 75,1 | 90,1 | 75,1 | 88,8 | 75,1 | 88,0 | 72,0 | 70 | | | | | | | | | | | | | | | | | | |
| 74 | - | - | - | - | - | 70,1 | 69,3 | 74,8 | 72,3 | 73,1 | 63,0 | - | 84,6 | 73,0 | 84,6 | 73,0 | 82,5 | 73,0 | 80,6 | 70,7 | 74 | | | | | | | | | | | | | | | | | | |
| 78 | - | - | - | - | - | 65,5 | 67,5 | 72,5 | 71,0 | 69,5 | 61,0 | - | 78,0 | 71,0 | 78,0 | 71,0 | 75,5 | 71,0 | 73,8 | 68,0 | 78 | | | | | | | | | | | | | | | | | | |
| 82 | - | - | - | - | - | 61,5 | 65,5 | 67,1 | 66,6 | 63,6 | 59,5 | - | 72,3 | 69,0 | 72,0 | 69,0 | 69,9 | 69,0 | 67,5 | 66,0 | 82 | | | | | | | | | | | | | | | | | | |
| 86 | - | - | - | - | - | 57,5 | 62,2 | 62,0 | 62,2 | 58,6 | 56,6 | - | 67,0 | 66,2 | 66,3 | 66,3 | 64,3 | 64,5 | 61,8 | 62,7 | 86 | | | | | | | | | | | | | | | | | | |
| 90 | - | - | - | - | - | 53,5 | 57,5 | 57,5 | 57,5 | 54,0 | 53,0 | - | 62,0 | 62,0 | 61,5 | 61,5 | 59,0 | 59,5 | 56,5 | 57,3 | 90 | | | | | | | | | | | | | | | | | | |
| 94 | - | - | - | - | - | 49,5 | 53,5 | 53,1 | 53,5 | 49,5 | 48,8 | - | 57,0 | 57,0 | 56,5 | 56,8 | 54,5 | 54,3 | 51,5 | 52,0 | 94 | | | | | | | | | | | | | | | | | | |
| 98 | - | - | - | - | - | 45,4 | 49,5 | 49,2 | 49,6 | 45,7 | 44,8 | - | 52,2 | 52,2 | 52,0 | 52,2 | 49,8 | 49,8 | 47,4 | 47,8 | 98 | | | | | | | | | | | | | | | | | | |
| 102 | - | - | - | - | - | 41,2 | 45,7 | 45,7 | 45,9 | 42,0 | 41,0 | - | 48,0 | 48,1 | 47,7 | 47,8 | 45,5 | 45,5 | 43,4 | 43,8 | 102 | | | | | | | | | | | | | | | | | | |
| 106 | - | - | - | - | - | 36,9 | 40,2 | 42,4 | 42,6 | 38,5 | 37,5 | - | 44,0 | 44,2 | 43,7 | 43,9 | 41,5 | 41,6 | 39,6 | 39,9 | 106 | | | | | | | | | | | | | | | | | | |
| 110 | - | - | - | - | - | 32,7 | 34,7 | 39,3 | 39,4 | 35,2 | 34,2 | - | 40,3 | 40,5 | 40,0 | 40,2 | 37,8 | 38,0 | 36,0 | 36,3 | 110 | | | | | | | | | | | | | | | | | | |
| 114 | - | - | - | - | - | 28,5 | 29,5 | 36,5 | 36,3 | 32,1 | 31,1 | - | 37,0 | 37,2 | 36,7 | 37,0 | 34,4 | 34,7 | 32,7 | 32,8 | 114 | | | | | | | | | | | | | | | | | | |
| 118 | - | - | - | - | - | 24,3 | 24,2 | 33,9 | 33,4 | 29,2 | 28,3 | - | 34,0 | 34,4 | 33,7 | 34,2 | 31,4 | 31,9 | 29,5 | 29,7 | 118 | | | | | | | | | | | | | | | | | | |
| 122 | - | - | - | - | - | 20,0 | 18,6 | 31,5 | 30,7 | 26,6 | 25,7 | - | 31,3 | 31,8 | 31,0 | 31,6 | 28,8 | 29,3 | 26,7 | 26,8 | 122 | | | | | | | | | | | | | | | | | | |
| 125 | - | - | - | - | - | 16,9 | 14,6 | 29,8 | 28,9 | 24,7 | 23,9 | - | 29,5 | 30,1 | 29,2 | 29,9 | 27,0 | 27,7 | 24,6 | 24,8 | 125 | | | | | | | | | | | | | | | | | | |
| 126 | - | - | - | - | - | 15,8 | - | 29,3 | 28,3 | 24,1 | 23,3 | - | 28,9 | 29,6 | 28,6 | 29,4 | 26,4 | 27,2 | 24,0 | 24,2 | 126 | | | | | | | | | | | | | | | | | | |
| 130 | - | - | - | - | - | 11,6 | - | 27,3 | - | 21,9 | - | - | 26,8 | - | 26,6 | - | 24,4 | - | 21,5 | - | 130 | | | | | | | | | | | | | | | | | | |

0t
 65t
 95t
 125t
 165t
 205t
 265t
 325t

LSL+LF_14: 225 t + 50 t

| 165 t + 50 t | | 8,40 m | | 9.8 m/s | | 360° | | ISO | | | | | | | | | | | | | | | | | | | | | | | |
|--------------|------|--------|------|----------|------|------|------|----------|------|------|------|----------|-------|-------|-------|----------|-------|-------|-------|-----------|-----|--|--|-----------|--|--|--|-----------|--|--|--|
| 138 m | | | | | | | | | | | | | | | | | | | | | | | | | | | | | | | |
| LSL+LF_2 | | | | LSL+LF_3 | | | | LSL+LF_4 | | | | LSL+LF_6 | | | | LSL+LF_8 | | | | LSL+LF_10 | | | | LSL+LF_12 | | | | LSL+LF_14 | | | |
| 12 m | | | | | | | | | | | | | | | | | | | | | | | | | | | | | | | |
| 0 t | | | | 0t-325t | | | | 0 t | | | | 0t-325t | | | | 0 t | | | | 0t-325t | | | | | | | | | | | |
| 15° | | | | 20° | | | | 30° | | | | 15° | | | | 20° | | | | 15° | | | | 20° | | | | | | | |
| m | t | t | t | t | t | t | t | t | t | t | t | t | t | t | t | t | t | t | t | m | | | | | | | | | | | |
| 18 | 73,0 | 75,0 | - | - | - | - | - | 89,0 | - | 94,5 | - | 85,0 | 111,0 | - | 117,0 | - | 126,0 | - | 144,0 | - | 18 | | | | | | | | | | |
| 19 | 72,5 | 75,0 | 73,5 | - | 78,0 | 81,5 | 79,5 | 89,0 | 89,0 | 94,2 | 92,5 | 80,5 | 111,0 | 109,0 | 117,0 | 115,0 | 126,0 | 123,0 | 144,0 | 127,0 | 19 | | | | | | | | | | |
| 20 | 72,5 | 75,0 | 73,0 | - | 73,5 | 81,5 | 79,5 | 89,0 | 89,0 | 94,0 | 92,5 | 76,0 | 111,0 | 109,0 | 117,0 | 115,0 | 126,0 | 123,0 | 144,0 | 125,0 | 20 | | | | | | | | | | |
| 21 | 69,5 | 74,5 | 72,7 | 68,0 | 70,0 | 81,2 | 79,2 | 89,0 | 89,0 | 94,0 | 92,5 | 72,1 | 110,7 | 109,0 | 117,0 | 115,0 | 126,0 | 123,0 | 144,0 | 123,0 | 21 | | | | | | | | | | |
| 22 | 67,0 | 74,0 | 72,5 | 67,5 | 66,5 | 81,0 | 79,0 | 89,0 | 89,0 | 94,0 | 92,5 | 68,2 | 110,5 | 109,0 | 117,0 | 115,0 | 126,0 | 123,0 | 144,0 | 121,0 | 22 | | | | | | | | | | |
| 24 | 60,0 | 73,5 | 72,0 | 67,5 | 59,5 | 80,5 | 78,5 | 89,0 | 89,0 | 94,0 | 92,0 | 60,5 | 110,0 | 109,0 | 117,0 | 115,0 | 126,0 | 121,0 | 144,0 | 118,0 | 24 | | | | | | | | | | |
| 26 | 54,5 | 73,5 | 71,5 | 67,0 | 53,9 | 80,0 | 78,0 | 89,0 | 89,0 | 93,5 | 92,0 | 54,5 | 109,5 | 108,0 | 116,5 | 115,0 | 125,5 | 118,0 | 143,5 | 115,0 | 26 | | | | | | | | | | |
| 28 | 49,1 | 73,0 | 71,5 | 67,0 | 48,3 | 79,5 | 77,5 | 89,0 | 89,0 | 93,0 | 91,5 | 48,6 | 109,0 | 108,0 | 116,0 | 114,0 | 125,0 | 115,0 | 143,0 | 112,0 | 28 | | | | | | | | | | |
| 30 | 44,4 | 72,5 | 71,0 | 66,5 | 43,8 | 78,7 | 77,0 | 89,0 | 89,0 | 92,5 | 91,5 | 43,8 | 108,5 | 107,0 | 116,0 | 112,0 | 125,0 | 112,0 | 142,0 | 109,0 | 30 | | | | | | | | | | |
| 34 | 36,6 | 71,1 | 69,6 | 65,8 | 35,7 | 77,5 | 76,0 | 89,0 | 88,6 | 91,5 | 90,1 | 35,1 | 107,5 | 105,0 | 115,0 | 106,6 | 124,5 | 106,6 | 137,0 | 103,5 | 34 | | | | | | | | | | |
| 38 | 29,8 | 69,8 | 68,5 | 65,0 | 29,2 | 76,5 | 74,8 | 89,0 | 88,1 | 90,5 | 88,1 | 28,0 | 106,3 | 101,8 | 113,3 | 101,8 | 123,0 | 101,8 | 129,0 | 98,7 | 38 | | | | | | | | | | |
| 42 | 24,0 | 69,0 | 67,5 | 64,0 | 23,4 | 75,5 | 73,5 | 89,0 | 87,5 | 89,5 | 85,5 | 21,8 | 105,0 | 97,5 | 112,0 | 97,5 | 121,0 | 97,5 | 122,0 | 94,5 | 42 | | | | | | | | | | |
| 46 | 19,3 | 67,6 | 66,1 | 62,6 | 18,8 | 73,8 | 72,1 | 87,6 | 85,8 | 87,8 | 81,8 | 16,9 | 103,0 | 93,5 | 108,6 | 93,5 | 115,6 | 93,5 | 116,0 | 90,5 | 46 | | | | | | | | | | |
| 50 | 15,1 | 66,1 | 64,8 | 61,1 | 14,6 | 72,1 | 70,6 | 85,8 | 84,3 | 86,0 | 78,5 | 12,5 | 101,0 | 89,8 | 104,6 | 89,8 | 111,3 | 89,8 | 110,0 | 86,8 | 50 | | | | | | | | | | |
| 54 | 11,5 | 64,5 | 63,5 | 59,5 | 11,0 | 70,5 | 69,0 | 84,0 | 83,0 | 84,0 | 75,5 | 8,6 | 99,0 | 86,5 | 102,0 | 86,5 | 108,0 | 86,5 | 104,6 | 83,5 | 54 | | | | | | | | | | |
| 58 | 8,2 | 63,1 | 62,1 | 57,8 | 7,8 | 69,1 | 67,6 | 82,5 | 80,4 | 81,5 | 72,8 | 5,3 | 97,0 | 83,7 | 100,0 | 83,7 | 103,0 | 83,5 | 100,0 | 80,5 | 58 | | | | | | | | | | |
| 60 | 6,6 | 62,5 | 61,5 | 57,0 | 6,3 | 68,5 | 67,0 | 81,0 | 80,0 | 80,5 | 71,5 | 3,7 | 96,0 | 82,0 | 99,0 | 82,0 | 101,0 | 82,0 | 98,1 | 79,3 | 60 | | | | | | | | | | |
| 62 | 5,0 | 61,7 | 61,0 | 56,3 | 4,7 | 66,6 | 65,7 | 79,5 | 77,1 | 79,0 | 70,3 | - | 95,0 | 80,8 | 96,5 | 80,6 | 99,1 | 80,6 | 96,3 | 77,9 | 62 | | | | | | | | | | |
| 63 | 4,2 | 61,4 | 60,6 | 56,0 | 3,9 | 66,2 | 65,1 | 78,7 | 76,7 | 78,5 | 69,7 | - | 94,5 | 80,1 | 96,0 | 80,0 | 98,2 | 80,0 | 95,4 | 77,2 | 63 | | | | | | | | | | |
| 66 | - | 60,5 | 59,5 | 54,5 | - | 65,0 | 64,0 | 77,5 | 75,5 | 77,0 | 68,0 | - | 94,0 | 78,0 | 94,5 | 78,0 | 95,5 | 78,0 | 91,8 | 75,3 | 66 | | | | | | | | | | |
| 70 | - | 58,1 | 57,1 | 53,5 | - | 62,8 | 62,3 | 75,1 | 72,5 | 74,5 | 65,6 | - | 88,3 | 75,6 | 89,1 | 75,6 | 89,5 | 75,6 | 86,5 | 73,0 | 70 | | | | | | | | | | |
| 74 | - | 56,1 | 55,5 | 52,3 | - | 61,3 | 60,1 | 73,1 | 69,6 | 72,5 | 63,6 | - | 83,0 | 73,5 | 83,3 | 73,5 | 83,0 | 73,5 | 79,5 | 70,6 | 74 | | | | | | | | | | |
| 78 | - | 54,5 | 53,5 | 51,0 | - | 60,0 | 58,5 | 71,5 | 68,0 | 70,5 | 62,0 | - | 77,0 | 71,5 | 77,0 | 71,5 | 76,0 | 71,5 | 72,8 | 68,6 | 78 | | | | | | | | | | |
| 82 | - | 53,1 | 52,1 | 50,1 | - | 57,6 | 56,6 | 66,1 | 65,3 | 65,5 | 60,0 | - | 71,3 | 69,5 | 71,3 | 69,5 | 70,3 | 69,1 | 66,5 | 67,0 | 82 | | | | | | | | | | |
| 86 | - | 51,2 | 50,6 | 49,2 | - | 56,3 | 55,2 | 61,5 | 61,6 | 60,5 | 58,4 | - | 65,5 | 65,8 | 66,0 | 66,0 | 64,8 | 65,3 | 60,8 | 61,8 | 86 | | | | | | | | | | |
| 90 | - | 50,0 | 49,8 | 47,8 | - | 54,5 | 53,5 | 56,5 | 57,0 | 55,5 | 56,0 | - | 60,5 | 60,5 | 60,5 | 61,0 | 59,5 | 60,0 | 55,5 | 56,2 | 90 | | | | | | | | | | |
| 94 | - | 49,0 | 48,4 | 47,0 | - | 53,1 | 51,1 | 52,5 | 52,6 | 51,4 | 51,7 | - | 55,8 | 55,8 | 55,8 | 56,0 | 55,1 | 55,3 | 50,5 | 51,0 | 94 | | | | | | | | | | |
| 98 | - | 48,1 | 47,6 | 46,1 | - | 50,6 | 47,9 | 48,5 | 48,7 | 47,5 | 47,6 | - | 51,1 | 51,1 | 51,0 | 51,0 | 50,8 | 50,8 | 46,5 | 47,0 | 98 | | | | | | | | | | |
| 102 | - | 47,2 | 46,8 | 45,6 | - | 46,9 | 44,6 | 44,9 | 45,1 | 43,9 | 43,9 | - | 47,0 | 47,1 | 46,9 | 47,0 | 46,4 | 46,5 | 42,7 | 43,0 | 102 | | | | | | | | | | |
| 106 | - | 43,9 | 43,9 | 43,7 | - | 43,0 | 41,2 | 41,6 | 41,8 | 40,6 | 40,4 | - | 43,0 | 43,2 | 42,9 | 43,1 | 42,4 | 42,5 | 38,9 | 39,2 | 106 | | | | | | | | | | |
| 110 | - | 40,8 | 41,0 | 41,3 | - | 39,2 | 37,9 | 38,5 | 38,7 | 37,5 | 37,1 | - | 39,3 | 39,5 | 39,2 | 39,4 | 38,6 | 38,9 | 35,4 | 35,6 | 110 | | | | | | | | | | |
| 114 | - | 38,0 | 38,1 | 33,5 | - | 35,4 | 34,5 | 35,7 | 35,9 | 34,7 | 34,0 | - | 36,0 | 36,3 | 35,8 | 36,1 | 35,2 | 35,5 | 32,1 | 32,2 | 114 | | | | | | | | | | |
| 118 | - | 35,3 | 35,5 | - | - | 31,5 | 31,1 | 33,1 | 33,3 | 32,0 | 31,2 | - | 33,0 | 33,3 | 32,8 | 33,2 | 32,2 | 32,6 | 29,0 | 29,1 | 118 | | | | | | | | | | |
| 122 | - | 32,9 | 33,1 | - | - | 27,6 | 27,8 | 30,7 | 30,8 | 29,4 | 28,5 | - | 30,2 | 30,7 | 29,9 | 30,5 | 29,4 | 29,9 | 26,1 | 26,3 | 122 | | | | | | | | | | |
| 126 | - | 30,7 | 30,8 | - | - | 24,1 | 24,5 | 28,5 | 28,6 | 26,9 | 26,0 | - | 27,7 | 28,4 | 27,5 | 28,2 | 27,0 | 27,6 | 23,4 | 23,6 | 126 | | | | | | | | | | |
| 128 | - | 29,7 | 29,8 | - | - | 22,1 | 22,8 | 27,4 | 27,5 | 25,7 | 24,9 | - | 26,6 | 27,3 | 26,4 | 27,2 | 25,9 | 26,6 | 22,2 | 22,3 | 128 | | | | | | | | | | |
| 130 | - | 28,7 | 11,8 | - | - | 20,1 | - | 26,4 | 22,3 | 24,6 | - | - | 25,6 | - | 25,4 | - | 24,9 | - | 21,0 | - | 130 | | | | | | | | | | |
| 133 | - | 27,2 | - | - | - | 17,3 | - | 25,0 | - | 23,0 | - | - | 24,1 | - | 24,0 | - | 23,5 | - | 19,3 | - | 133 | | | | | | | | | | |

0t 65t 95t 125t 165t 205t 265t 325t

LSL+LF_14: 225t + 50t

| 165 t + 50 t | | 8,40 m | | 9.8 m/s | | 360° | | ISO | | | | | | | | | | | | | | | | | | | | | | | |
|--------------|---|--------|---|-----------|------|------|------|----------|------|------|------|-----------|-------|-------|-------|----------|-------|-------|-------|-----------|-----|--|--|-----------|--|--|--|-----------|--|--|--|
| 141 m | | | | | | | | | | | | | | | | | | | | | | | | | | | | | | | |
| LSL+LF_2 | | | | LSL+LF_3 | | | | LSL+LF_4 | | | | LSL+LF_6 | | | | LSL+LF_8 | | | | LSL+LF_10 | | | | LSL+LF_12 | | | | LSL+LF_14 | | | |
| 12 m | | | | | | | | | | | | | | | | | | | | | | | | | | | | | | | |
| 0 t | | | | 0 t-325 t | | | | 0 t | | | | 0 t-325 t | | | | 0 t | | | | 0 t-325 t | | | | | | | | | | | |
| 15° | | | | 20° | | | | 30° | | | | 15° | | | | 20° | | | | 15° | | | | 20° | | | | | | | |
| m | t | t | t | t | t | t | t | t | t | t | t | t | t | t | t | t | t | t | t | t | m | | | | | | | | | | |
| 18 | - | - | - | - | - | - | 89,0 | - | 90,0 | - | 83,0 | 106,0 | - | 110,0 | - | 120,0 | - | 137,0 | - | 18 | | | | | | | | | | | |
| 19 | - | - | - | - | 75,5 | 78,0 | 76,5 | 89,0 | 88,0 | 90,0 | 88,5 | 78,2 | 106,0 | - | 110,0 | - | 120,0 | - | 137,0 | - | 19 | | | | | | | | | | |
| 20 | - | - | - | - | 71,5 | 78,0 | 76,5 | 89,0 | 88,0 | 90,0 | 88,5 | 73,5 | 106,0 | 104,0 | 110,0 | 109,0 | 120,0 | 118,0 | 137,0 | 125,0 | 20 | | | | | | | | | | |
| 22 | - | - | - | - | 64,5 | 77,5 | 76,0 | 88,7 | 87,5 | 89,7 | 88,0 | 66,0 | 105,5 | 104,0 | 109,5 | 108,0 | 120,0 | 118,0 | 137,0 | 122,0 | 22 | | | | | | | | | | |
| 24 | - | - | - | - | 57,5 | 77,0 | 75,5 | 88,5 | 87,5 | 89,5 | 88,0 | 58,5 | 105,0 | 104,0 | 109,0 | 108,0 | 120,0 | 118,0 | 137,0 | 118,0 | 24 | | | | | | | | | | |
| 26 | - | - | - | - | 52,1 | 76,7 | 75,0 | 88,5 | 87,0 | 89,0 | 87,5 | 52,7 | 104,5 | 103,0 | 108,5 | 108,0 | 120,0 | 118,0 | 136,5 | 115,0 | 26 | | | | | | | | | | |
| 28 | - | - | - | - | 46,7 | 76,5 | 75,0 | 88,5 | 87,0 | 88,5 | 87,5 | 46,9 | 104,0 | 103,0 | 108,0 | 107,0 | 120,0 | 115,0 | 136,0 | 112,0 | 28 | | | | | | | | | | |
| 30 | - | - | - | - | 42,3 | 76,0 | 74,5 | 88,0 | 86,5 | 88,2 | 87,5 | 42,1 | 104,0 | 103,0 | 107,5 | 107,0 | 119,5 | 112,0 | 135,5 | 109,5 | 30 | | | | | | | | | | |
| 34 | - | - | - | - | 34,3 | 75,0 | 73,5 | 87,2 | 85,8 | 87,5 | 86,5 | 33,5 | 103,5 | 101,6 | 106,5 | 105,0 | 118,5 | 106,6 | 134,5 | 104,0 | 34 | | | | | | | | | | |
| 38 | - | - | - | - | 27,8 | 73,8 | 72,5 | 86,6 | 85,1 | 86,5 | 85,5 | 26,6 | 102,3 | 100,0 | 105,3 | 102,0 | 117,0 | 102,0 | 130,0 | 99,0 | 38 | | | | | | | | | | |
| 42 | - | - | - | - | 22,0 | 73,0 | 71,5 | 86,0 | 84,5 | 85,5 | 84,5 | 20,4 | 101,0 | 98,0 | 104,0 | 98,0 | 115,0 | 98,0 | 123,0 | 95,0 | 42 | | | | | | | | | | |
| 46 | - | - | - | - | 17,4 | 71,6 | 70,1 | 84,6 | 83,1 | 84,1 | 82,1 | 15,5 | 99,0 | 94,3 | 102,0 | 94,3 | 110,6 | 94,3 | 117,0 | 91,0 | 46 | | | | | | | | | | |
| 50 | - | - | - | - | 13,3 | 70,3 | 69,0 | 83,5 | 82,0 | 82,8 | 79,3 | 11,1 | 97,0 | 90,6 | 100,1 | 90,6 | 106,6 | 90,6 | 111,0 | 87,6 | 50 | | | | | | | | | | |
| 54 | - | - | - | - | 9,7 | 69,0 | 68,0 | 82,5 | 81,0 | 81,5 | 76,0 | 7,2 | 95,0 | 87,0 | 98,5 | 87,0 | 104,0 | 87,0 | 105,6 | 84,3 | 54 | | | | | | | | | | |
| 58 | - | - | - | - | 6,7 | 67,8 | 66,8 | 80,0 | 79,1 | 79,8 | 73,5 | 3,9 | 93,5 | 84,2 | 97,0 | 84,1 | 100,6 | 84,1 | 101,0 | 81,0 | 58 | | | | | | | | | | |
| 62 | - | - | - | - | 3,6 | 65,8 | 64,8 | 77,8 | 77,3 | 77,6 | 70,8 | - | 91,1 | 81,1 | 95,0 | 81,1 | 97,0 | 81,1 | 97,3 | 78,3 | 62 | | | | | | | | | | |
| 66 | - | - | - | - | - | 64,5 | 63,5 | 76,5 | 76,0 | 76,0 | 68,5 | - | 89,5 | 78,5 | 93,0 | 78,5 | 94,0 | 78,5 | 91,6 | 75,8 | 66 | | | | | | | | | | |
| 70 | - | - | - | - | - | 62,6 | 61,5 | 74,1 | 73,3 | 73,6 | 66,1 | - | 85,8 | 76,1 | 87,0 | 76,1 | 87,6 | 76,1 | 84,0 | 73,5 | 70 | | | | | | | | | | |
| 74 | - | - | - | - | - | 61,0 | 60,0 | 72,6 | 70,6 | 71,6 | 64,1 | - | 81,0 | 74,0 | 81,0 | 74,0 | 81,3 | 74,0 | 77,3 | 71,1 | 74 | | | | | | | | | | |
| 78 | - | - | - | - | - | 59,0 | 59,0 | 71,0 | 69,0 | 69,0 | 62,5 | - | 75,0 | 72,0 | 75,0 | 72,0 | 75,0 | 72,0 | 70,6 | 69,0 | 78 | | | | | | | | | | |
| 82 | - | - | - | - | - | 58,0 | 57,0 | 65,6 | 65,0 | 64,2 | 60,5 | - | 69,3 | 68,6 | 69,3 | 68,6 | 69,0 | 69,5 | 64,5 | 65,0 | 82 | | | | | | | | | | |
| 86 | - | - | - | - | - | 56,2 | 56,0 | 60,3 | 60,8 | 59,5 | 58,1 | - | 64,0 | 64,2 | 63,8 | 64,3 | 63,8 | 63,8 | 58,9 | 59,3 | 86 | | | | | | | | | | |
| 90 | - | - | - | - | - | 55,0 | 54,0 | 55,5 | 56,0 | 54,5 | 54,5 | - | 59,0 | 59,0 | 58,5 | 59,0 | 58,5 | 58,5 | 53,6 | 54,1 | 90 | | | | | | | | | | |
| 94 | - | - | - | - | - | 52,6 | 51,6 | 51,5 | 51,8 | 50,0 | 50,2 | - | 54,0 | 54,3 | 53,8 | 54,0 | 53,3 | 53,5 | 49,0 | 49,5 | 94 | | | | | | | | | | |
| 98 | - | - | - | - | - | 49,6 | 48,5 | 47,5 | 47,8 | 46,4 | 46,1 | - | 49,5 | 49,9 | 49,4 | 49,4 | 48,9 | 49,3 | 44,6 | 45,2 | 98 | | | | | | | | | | |
| 102 | - | - | - | - | - | 45,9 | 44,5 | 43,9 | 44,2 | 42,8 | 42,4 | - | 45,5 | 45,6 | 45,3 | 45,4 | 44,8 | 44,9 | 40,8 | 41,1 | 102 | | | | | | | | | | |
| 106 | - | - | - | - | - | 42,6 | 40,4 | 40,6 | 40,8 | 39,4 | 38,9 | - | 41,5 | 41,7 | 41,3 | 41,4 | 40,8 | 40,9 | 37,0 | 37,3 | 106 | | | | | | | | | | |
| 110 | - | - | - | - | - | 39,0 | 36,3 | 37,5 | 37,7 | 36,4 | 35,7 | - | 37,9 | 38,2 | 37,7 | 37,9 | 37,1 | 37,3 | 33,6 | 33,8 | 110 | | | | | | | | | | |
| 114 | - | - | - | - | - | 35,0 | 32,2 | 34,7 | 34,9 | 33,5 | 32,6 | - | 34,5 | 34,8 | 34,3 | 34,5 | 33,7 | 33,9 | 30,3 | 30,5 | 114 | | | | | | | | | | |
| 118 | - | - | - | - | - | 30,6 | 28,3 | 32,1 | 32,3 | 30,7 | 29,7 | - | 31,5 | 31,8 | 31,1 | 31,5 | 30,6 | 30,8 | 27,2 | 27,3 | 118 | | | | | | | | | | |
| 122 | - | - | - | - | - | 26,2 | 24,4 | 29,7 | 29,8 | 27,9 | 27,0 | - | 28,7 | 29,1 | 28,4 | 28,8 | 27,8 | 28,2 | 24,3 | 24,4 | 122 | | | | | | | | | | |
| 126 | - | - | - | - | - | 22,2 | 20,5 | 27,5 | 27,6 | 25,5 | 24,6 | - | 26,1 | 26,6 | 25,8 | 26,4 | 25,2 | 25,8 | 21,6 | 21,7 | 126 | | | | | | | | | | |
| 130 | - | - | - | - | - | 17,8 | 16,3 | 25,4 | 25,5 | 23,2 | 22,3 | - | 23,9 | 24,6 | 23,6 | 24,3 | 23,0 | 23,8 | 19,1 | 19,3 | 130 | | | | | | | | | | |
| 131 | - | - | - | - | - | 16,7 | - | 24,9 | 25,0 | 22,6 | 21,8 | - | 23,3 | 24,1 | 23,1 | 23,8 | 22,5 | 23,3 | 18,5 | 18,7 | 131 | | | | | | | | | | |
| 132 | - | - | - | - | - | 15,9 | - | 24,4 | 24,5 | 22,1 | - | - | 22,8 | - | 22,6 | - | 22,0 | - | 17,9 | - | 132 | | | | | | | | | | |
| 134 | - | - | - | - | - | 13,7 | - | 23,4 | - | 21,0 | - | - | 21,8 | - | 21,6 | - | 21,0 | - | 16,8 | - | 134 | | | | | | | | | | |
| 135 | - | - | - | - | - | 12,8 | - | 23,0 | - | 20,5 | - | - | 21,4 | - | 21,2 | - | 20,6 | - | 16,3 | - | 135 | | | | | | | | | | |

0 t 65 t 95 t 125 t 165 t 205 t 265 t 325 t

LSL+LF_14: 225 t + 50 t

| 165 t + 50 t | | 8,40 m | | 9.8 m/s | | 360° | | ISO | | | | | | | | | | | | | | | | | | | | | | | |
|--------------|------|--------|------|----------|------|------|------|----------|------|------|------|----------|-------|------|-------|----------|-------|-------|-------|-----------|-----|--|--|-----------|--|--|--|-----------|--|--|--|
| 144 m | | | | | | | | | | | | | | | | | | | | | | | | | | | | | | | |
| LSL+LF_2 | | | | LSL+LF_3 | | | | LSL+LF_4 | | | | LSL+LF_6 | | | | LSL+LF_8 | | | | LSL+LF_10 | | | | LSL+LF_12 | | | | LSL+LF_14 | | | |
| 12 m | | | | | | | | | | | | | | | | | | | | | | | | | | | | | | | |
| 0 t | | | | 0t-325t | | | | 0 t | | | | 0t-325t | | | | 0 t | | | | 0t-325t | | | | | | | | | | | |
| 15° | | | | 20° | | | | 30° | | | | 15° | | | | 20° | | | | 15° | | | | 20° | | | | | | | |
| m | t | t | t | t | t | t | t | t | t | t | t | t | t | t | t | t | t | t | t | t | m | | | | | | | | | | |
| 19 | 63,0 | 65,0 | 63,5 | - | - | - | 73,5 | 85,0 | - | - | - | 76,5 | 100,0 | - | 105,0 | - | 114,0 | - | 131,0 | - | 19 | | | | | | | | | | |
| 20 | 63,0 | 65,0 | 63,5 | - | 70,0 | 75,0 | 73,5 | 85,0 | 83,5 | 88,0 | 86,0 | 72,0 | 100,0 | 99,0 | 105,0 | 103,0 | 114,0 | 112,0 | 131,0 | 126,0 | 20 | | | | | | | | | | |
| 21 | 62,5 | 64,7 | 63,2 | 59,5 | 66,5 | 74,7 | 73,2 | 84,8 | 83,5 | 88,0 | 86,0 | 68,2 | 100,0 | 98,7 | 104,7 | 103,0 | 114,0 | 112,0 | 131,0 | 124,0 | 21 | | | | | | | | | | |
| 22 | 62,5 | 64,5 | 63,0 | 59,5 | 63,0 | 74,5 | 73,0 | 84,7 | 83,5 | 88,0 | 86,0 | 64,5 | 100,0 | 98,5 | 104,5 | 103,0 | 114,0 | 112,0 | 131,0 | 122,0 | 22 | | | | | | | | | | |
| 24 | 58,0 | 64,0 | 62,5 | 59,0 | 56,0 | 74,0 | 72,5 | 84,5 | 83,0 | 88,0 | 86,0 | 57,0 | 100,0 | 98,5 | 104,0 | 103,0 | 114,0 | 112,0 | 131,0 | 119,0 | 24 | | | | | | | | | | |
| 26 | 52,0 | 63,5 | 62,0 | 59,0 | 50,7 | 73,7 | 72,0 | 84,5 | 83,0 | 87,7 | 85,5 | 51,2 | 99,7 | 98,5 | 103,5 | 102,0 | 114,0 | 112,0 | 130,5 | 116,0 | 26 | | | | | | | | | | |
| 28 | 47,0 | 63,0 | 61,5 | 58,5 | 45,4 | 73,5 | 71,5 | 84,5 | 82,5 | 87,5 | 85,5 | 45,5 | 99,5 | 98,0 | 103,0 | 102,0 | 114,0 | 112,0 | 130,0 | 113,0 | 28 | | | | | | | | | | |
| 30 | 42,3 | 62,5 | 61,0 | 58,0 | 41,0 | 72,7 | 71,0 | 84,0 | 82,5 | 87,2 | 85,0 | 40,8 | 99,2 | 98,0 | 103,0 | 102,0 | 113,5 | 112,0 | 129,5 | 110,0 | 30 | | | | | | | | | | |
| 34 | 34,7 | 61,1 | 60,0 | 57,0 | 33,1 | 71,5 | 70,0 | 83,0 | 81,5 | 86,5 | 84,3 | 32,3 | 98,5 | 97,6 | 102,5 | 101,3 | 112,5 | 107,3 | 128,5 | 104,5 | 34 | | | | | | | | | | |
| 38 | 28,0 | 60,0 | 58,8 | 56,1 | 26,7 | 70,5 | 69,0 | 82,1 | 80,6 | 85,5 | 83,6 | 25,4 | 97,5 | 96,8 | 101,3 | 100,1 | 111,3 | 102,8 | 127,0 | 100,0 | 38 | | | | | | | | | | |
| 42 | 22,3 | 59,0 | 57,5 | 55,5 | 21,0 | 69,5 | 68,0 | 81,5 | 80,0 | 84,5 | 83,0 | 19,3 | 96,5 | 95,5 | 100,0 | 98,5 | 110,0 | 98,5 | 123,3 | 95,8 | 42 | | | | | | | | | | |
| 46 | 17,7 | 57,6 | 56,5 | 54,1 | 16,4 | 67,8 | 66,3 | 80,1 | 78,6 | 83,5 | 81,6 | 14,5 | 94,8 | 93,5 | 98,3 | 94,8 | 105,3 | 94,8 | 118,0 | 91,5 | 46 | | | | | | | | | | |
| 50 | 13,6 | 56,3 | 55,3 | 53,0 | 12,3 | 66,3 | 64,8 | 78,8 | 77,3 | 82,0 | 79,5 | 10,1 | 93,0 | 91,0 | 96,3 | 91,3 | 102,4 | 91,3 | 112,6 | 88,1 | 50 | | | | | | | | | | |
| 54 | 10,0 | 55,0 | 54,0 | 52,0 | 8,7 | 65,0 | 63,5 | 77,5 | 76,0 | 80,0 | 76,5 | 6,2 | 91,0 | 88,0 | 94,0 | 88,0 | 99,5 | 88,0 | 107,5 | 84,9 | 54 | | | | | | | | | | |
| 57 | 7,7 | 54,1 | 53,0 | 51,2 | 6,5 | 64,0 | 62,3 | 75,9 | 74,1 | 78,9 | 74,7 | 3,7 | 89,6 | 85,7 | 92,6 | 85,7 | 97,5 | 85,7 | 103,5 | 82,5 | 57 | | | | | | | | | | |
| 58 | 6,9 | 53,8 | 52,6 | 51,0 | 5,7 | 63,5 | 62,0 | 75,6 | 73,7 | 78,6 | 74,0 | - | 89,2 | 85,0 | 92,2 | 85,0 | 96,8 | 85,0 | 102,0 | 82,0 | 58 | | | | | | | | | | |
| 61 | 4,6 | 52,6 | 51,7 | 50,0 | 3,6 | 62,1 | 61,1 | 74,1 | 72,0 | 77,6 | 71,9 | - | 88,0 | 82,8 | 91,0 | 82,8 | 93,9 | 82,8 | 97,7 | 79,7 | 61 | | | | | | | | | | |
| 62 | 3,9 | 52,3 | 51,5 | 49,8 | - | 61,8 | 60,8 | 73,8 | 71,1 | 77,3 | 71,3 | - | 87,6 | 82,1 | 90,6 | 82,1 | 92,6 | 82,1 | 96,3 | 79,0 | 62 | | | | | | | | | | |
| 66 | - | 51,0 | 50,5 | 49,0 | - | 60,5 | 59,5 | 72,5 | 69,0 | 76,0 | 69,0 | - | 86,0 | 79,5 | 89,0 | 79,5 | 90,0 | 79,5 | 89,8 | 76,3 | 66 | | | | | | | | | | |
| 70 | - | 49,9 | 49,1 | 47,8 | - | 58,3 | 57,1 | 70,1 | 66,6 | 73,6 | 66,6 | - | 83,3 | 77,1 | 84,3 | 77,1 | 85,3 | 77,1 | 82,5 | 74,0 | 70 | | | | | | | | | | |
| 74 | - | 48,1 | 47,7 | 46,7 | - | 56,3 | 55,3 | 67,6 | 64,8 | 71,5 | 64,6 | - | 79,0 | 74,8 | 79,0 | 74,8 | 79,8 | 74,8 | 75,8 | 72,0 | 74 | | | | | | | | | | |
| 78 | - | 46,7 | 46,0 | 45,6 | - | 55,0 | 54,0 | 66,0 | 63,5 | 68,5 | 63,0 | - | 73,0 | 72,5 | 73,0 | 72,5 | 73,5 | 72,5 | 69,1 | 69,3 | 78 | | | | | | | | | | |
| 82 | - | 45,5 | 44,8 | 43,8 | - | 53,1 | 52,5 | 64,0 | 61,1 | 63,3 | 61,0 | - | 67,8 | 67,8 | 67,5 | 68,1 | 67,6 | 68,5 | 63,5 | 64,0 | 82 | | | | | | | | | | |
| 86 | - | 43,7 | 43,2 | 42,3 | - | 51,8 | 50,9 | 59,6 | 58,6 | 58,5 | 57,8 | - | 62,5 | 63,0 | 62,5 | 62,8 | 62,5 | 62,8 | 57,5 | 58,6 | 86 | | | | | | | | | | |
| 90 | - | 42,7 | 42,2 | 41,4 | - | 50,5 | 49,9 | 55,0 | 53,5 | 53,5 | 53,5 | - | 57,5 | 58,0 | 57,5 | 57,5 | 57,5 | 57,5 | 52,6 | 53,3 | 90 | | | | | | | | | | |
| 94 | - | 41,3 | 40,8 | 40,6 | - | 49,2 | 47,8 | 50,6 | 50,9 | 49,5 | 48,9 | - | 52,7 | 53,2 | 52,5 | 53,0 | 52,5 | 52,8 | 47,9 | 48,5 | 94 | | | | | | | | | | |
| 98 | - | 40,4 | 40,0 | 39,3 | - | 47,3 | 44,8 | 46,7 | 46,9 | 45,6 | 44,8 | - | 48,4 | 48,5 | 48,4 | 48,4 | 47,9 | 48,3 | 43,5 | 44,1 | 98 | | | | | | | | | | |
| 102 | - | 39,6 | 39,2 | 38,6 | - | 44,7 | 40,5 | 43,0 | 43,2 | 41,8 | 41,0 | - | 44,4 | 44,5 | 44,2 | 44,4 | 43,9 | 44,0 | 39,6 | 40,1 | 102 | | | | | | | | | | |
| 106 | - | 38,5 | 38,2 | 37,8 | - | 40,2 | 36,4 | 39,7 | 39,9 | 38,4 | 37,5 | - | 40,4 | 40,6 | 40,3 | 40,5 | 39,9 | 40,0 | 35,9 | 36,3 | 106 | | | | | | | | | | |
| 110 | - | 37,7 | 37,5 | 37,2 | - | 35,7 | 32,3 | 36,6 | 36,8 | 35,2 | 34,3 | - | 36,9 | 37,1 | 36,6 | 36,9 | 36,2 | 36,3 | 32,5 | 32,7 | 110 | | | | | | | | | | |
| 114 | - | 36,7 | 36,9 | 36,7 | - | 31,3 | 28,0 | 33,8 | 33,9 | 32,2 | 31,3 | - | 33,5 | 33,7 | 33,2 | 33,5 | 32,8 | 32,9 | 29,2 | 29,5 | 114 | | | | | | | | | | |
| 118 | - | 34,1 | 34,3 | 34,5 | - | 27,0 | 23,6 | 31,2 | 31,3 | 29,3 | 28,4 | - | 30,3 | 30,6 | 30,1 | 30,4 | 29,7 | 29,9 | 26,2 | 26,4 | 118 | | | | | | | | | | |
| 119 | - | 33,5 | 33,6 | 15,3 | - | 26,0 | 22,6 | 30,5 | 30,7 | 28,6 | 27,7 | - | 29,6 | 29,9 | 29,4 | 29,7 | 28,9 | 29,1 | 25,4 | 25,6 | 119 | | | | | | | | | | |
| 122 | - | 31,7 | 31,8 | - | - | 22,7 | 19,6 | 28,7 | 28,9 | 26,7 | 25,8 | - | 27,5 | 27,9 | 27,3 | 27,7 | 26,8 | 27,1 | 23,3 | 23,5 | 122 | | | | | | | | | | |
| 126 | - | 29,4 | 29,5 | - | - | 18,6 | 15,4 | 26,5 | 26,6 | 24,2 | 23,3 | - | 24,9 | 25,4 | 24,7 | 25,2 | 24,2 | 24,6 | 20,6 | 20,8 | 126 | | | | | | | | | | |
| 130 | - | 27,4 | 27,5 | - | - | 14,1 | 10,9 | 24,4 | 24,5 | 21,9 | 21,0 | - | 22,7 | 23,2 | 22,4 | 23,0 | 21,9 | 22,5 | 18,1 | 18,3 | 130 | | | | | | | | | | |
| 132 | - | 26,4 | 26,5 | - | - | 12,1 | 8,8 | 23,4 | 23,5 | 20,8 | 19,9 | - | 21,6 | 22,2 | 21,3 | 22,0 | 20,8 | 21,5 | 16,9 | 17,1 | 132 | | | | | | | | | | |
| 133 | - | 25,9 | 26,0 | - | - | 10,9 | - | 22,9 | 23,0 | 20,3 | 19,4 | - | 21,1 | 21,8 | 20,8 | 21,6 | 20,3 | 21,1 | 16,4 | 16,6 | 133 | | | | | | | | | | |
| 134 | - | 25,4 | 25,5 | - | - | 9,8 | - | 22,4 | 22,6 | 19,8 | - | - | 20,6 | - | 20,4 | - | 19,9 | - | 15,8 | - | 134 | | | | | | | | | | |
| 135 | - | 25,0 | 8,8 | - | - | 8,7 | - | 21,9 | - | 19,3 | - | - | 20,2 | - | 19,9 | - | 19,4 | - | 15,2 | - | 135 | | | | | | | | | | |
| 138 | - | 23,6 | - | - | - | 5,5 | - | 20,5 | - | 17,8 | - | - | 18,8 | - | 18,6 | - | 18,1 | - | 13,7 | - | 138 | | | | | | | | | | |

0t 65t 95t 125t 165t 205t 265t 325t

LSL+LF_14: 225t + 50t

| 165 t + 50 t | | 8,40 m | | 9.8 m/s | | 360° | | ISO | | | | | | | | | | | | |
|--------------|------|--------|-----------|---------|------|----------|------|------|----------|------|-------|-----------|-------|-------|-----------|-------|-----|-----------|---|--|
| 147 m | | | | | | | | | | | | | | | | | | | | |
| LSL+LF_3 | | | LSL+LF_4 | | | LSL+LF_6 | | | LSL+LF_8 | | | LSL+LF_10 | | | LSL+LF_12 | | | LSL+LF_14 | | |
| 12 m | | | | | | | | | | | | | | | | | | | | |
| 0 t | | | 0 t-325 t | | | | | | 0 t | | | 0 t-325 t | | | | | | | | |
| 15° | | 20° | | 15° | | 20° | | 15° | | 20° | | 15° | | 20° | | 15° | | 20° | | |
| m | t | t | t | t | t | t | t | t | t | t | t | t | t | t | t | t | t | t | m | |
| 19 | - | - | - | 81,5 | - | 83,5 | - | 74,5 | 96,0 | - | 100,0 | - | 108,0 | - | 124,0 | - | 19 | | | |
| 20 | 68,0 | 72,0 | 70,5 | 81,0 | 80,5 | 83,5 | 82,0 | 70,0 | 96,0 | 94,5 | 100,0 | 98,5 | 108,0 | 106,0 | 124,0 | 122,0 | 20 | | | |
| 22 | 61,2 | 71,5 | 70,0 | 81,0 | 80,0 | 83,2 | 82,0 | 62,5 | 95,7 | 94,0 | 100,0 | 98,5 | 107,5 | 106,0 | 124,0 | 122,0 | 22 | | | |
| 24 | 54,5 | 71,0 | 70,0 | 81,0 | 80,0 | 83,0 | 81,5 | 55,0 | 95,5 | 94,0 | 100,0 | 98,5 | 107,0 | 106,0 | 124,0 | 119,0 | 24 | | | |
| 26 | 49,1 | 70,7 | 69,5 | 80,7 | 79,5 | 82,7 | 81,5 | 49,4 | 95,2 | 94,0 | 99,5 | 98,0 | 106,5 | 106,0 | 124,0 | 116,0 | 26 | | | |
| 28 | 43,8 | 70,5 | 69,0 | 80,5 | 79,5 | 82,5 | 81,5 | 43,8 | 95,0 | 93,5 | 99,0 | 98,0 | 106,0 | 105,0 | 124,0 | 113,0 | 28 | | | |
| 30 | 39,5 | 70,0 | 68,5 | 80,2 | 79,0 | 82,2 | 81,0 | 39,1 | 94,7 | 93,5 | 98,7 | 97,5 | 106,0 | 105,0 | 123,0 | 110,5 | 30 | | | |
| 34 | 31,6 | 69,0 | 67,5 | 79,5 | 78,3 | 81,5 | 80,6 | 30,7 | 94,2 | 93,1 | 98,2 | 96,8 | 105,0 | 103,6 | 122,0 | 105,5 | 34 | | | |
| 38 | 25,2 | 68,0 | 66,5 | 78,6 | 77,6 | 80,6 | 80,1 | 23,9 | 93,3 | 92,3 | 97,3 | 95,8 | 103,3 | 101,8 | 121,0 | 100,7 | 38 | | | |
| 42 | 19,6 | 67,0 | 65,5 | 78,0 | 77,0 | 80,0 | 79,5 | 17,8 | 92,0 | 91,0 | 96,0 | 94,5 | 102,0 | 99,5 | 118,6 | 96,5 | 42 | | | |
| 46 | 15,1 | 66,0 | 64,5 | 77,3 | 76,0 | 79,0 | 78,5 | 13,0 | 90,3 | 89,0 | 94,0 | 92,5 | 100,0 | 95,5 | 116,0 | 92,5 | 46 | | | |
| 50 | 11,1 | 64,8 | 63,5 | 76,4 | 75,1 | 77,7 | 77,2 | 8,6 | 88,5 | 87,1 | 92,0 | 90,5 | 97,2 | 91,9 | 112,6 | 88,8 | 50 | | | |
| 54 | 7,5 | 63,5 | 62,5 | 75,5 | 74,0 | 76,5 | 76,0 | 4,8 | 86,5 | 85,5 | 89,5 | 88,5 | 94,5 | 88,5 | 108,3 | 85,5 | 54 | | | |
| 55 | 6,7 | 63,2 | 62,0 | 74,6 | 73,2 | 76,1 | 75,5 | 4,0 | 86,0 | 85,0 | 89,0 | 87,7 | 93,3 | 87,7 | 107,0 | 84,7 | 55 | | | |
| 58 | 4,4 | 62,2 | 61,0 | 73,6 | 72,5 | 75,1 | 74,0 | - | 84,8 | 83,8 | 87,8 | 85,5 | 91,3 | 85,5 | 102,0 | 82,5 | 58 | | | |
| 59 | 3,7 | 61,8 | 60,7 | 73,3 | 72,2 | 74,8 | 73,5 | - | 84,4 | 83,4 | 87,4 | 84,7 | 90,6 | 84,7 | 100,0 | 81,8 | 59 | | | |
| 62 | - | 60,8 | 59,8 | 72,0 | 70,5 | 74,0 | 71,8 | - | 83,1 | 81,6 | 85,5 | 82,6 | 87,6 | 82,6 | 94,3 | 79,8 | 62 | | | |
| 66 | - | 59,5 | 58,5 | 71,0 | 69,5 | 73,0 | 69,5 | - | 81,5 | 80,0 | 83,5 | 80,0 | 85,0 | 80,0 | 87,0 | 77,1 | 66 | | | |
| 70 | - | 58,0 | 57,0 | 69,0 | 67,1 | 71,6 | 67,5 | - | 79,3 | 77,3 | 81,1 | 77,6 | 82,0 | 77,3 | 80,0 | 74,5 | 70 | | | |
| 74 | - | 56,0 | 55,0 | 67,3 | 65,3 | 69,3 | 65,5 | - | 76,0 | 75,0 | 77,0 | 75,0 | 77,3 | 74,6 | 73,6 | 72,1 | 74 | | | |
| 78 | - | 55,0 | 54,0 | 66,0 | 63,5 | 66,0 | 63,5 | - | 71,0 | 72,0 | 71,0 | 72,0 | 71,0 | 72,0 | 67,5 | 68,0 | 78 | | | |
| 82 | - | 53,0 | 52,3 | 63,6 | 62,0 | 61,2 | 60,2 | - | 65,6 | 66,1 | 65,6 | 66,5 | 65,6 | 66,2 | 61,5 | 62,0 | 82 | | | |
| 86 | - | 51,7 | 51,0 | 58,6 | 58,6 | 56,8 | 55,8 | - | 60,6 | 61,0 | 60,5 | 61,0 | 60,5 | 61,0 | 56,0 | 56,8 | 86 | | | |
| 90 | - | 50,5 | 50,0 | 54,0 | 54,0 | 52,5 | 51,5 | - | 56,0 | 56,0 | 55,5 | 56,0 | 55,5 | 56,0 | 51,0 | 51,6 | 90 | | | |
| 94 | - | 49,4 | 48,6 | 49,5 | 49,9 | 48,3 | 47,3 | - | 51,3 | 51,6 | 51,1 | 51,5 | 50,9 | 51,2 | 46,2 | 46,8 | 94 | | | |
| 98 | - | 47,2 | 46,0 | 45,7 | 46,0 | 44,3 | 43,3 | - | 47,1 | 47,3 | 46,9 | 47,1 | 46,5 | 46,7 | 41,8 | 42,4 | 98 | | | |
| 102 | - | 44,0 | 41,9 | 42,0 | 42,2 | 40,4 | 39,4 | - | 42,9 | 43,1 | 42,7 | 42,9 | 42,3 | 42,4 | 37,8 | 38,3 | 102 | | | |
| 106 | - | 40,7 | 37,1 | 38,7 | 38,9 | 36,9 | 36,0 | - | 39,1 | 39,2 | 38,9 | 39,0 | 38,4 | 38,5 | 34,1 | 34,5 | 106 | | | |
| 110 | - | 37,0 | 32,4 | 35,6 | 35,8 | 33,7 | 32,8 | - | 35,4 | 35,6 | 35,2 | 35,4 | 34,7 | 34,8 | 30,7 | 31,0 | 110 | | | |
| 114 | - | 32,2 | 28,1 | 32,7 | 32,9 | 30,7 | 29,8 | - | 32,0 | 32,2 | 31,8 | 32,0 | 31,3 | 31,4 | 27,5 | 27,8 | 114 | | | |
| 118 | - | 27,3 | 23,3 | 30,1 | 30,3 | 27,9 | 27,0 | - | 28,9 | 29,1 | 28,7 | 29,0 | 28,2 | 28,4 | 24,4 | 24,6 | 118 | | | |
| 122 | - | 23,0 | 18,9 | 27,7 | 27,8 | 25,3 | 24,4 | - | 26,0 | 26,4 | 25,8 | 26,2 | 25,3 | 25,6 | 21,6 | 21,7 | 122 | | | |
| 126 | - | 18,7 | 14,4 | 25,4 | 25,6 | 22,8 | 21,9 | - | 23,4 | 23,8 | 23,2 | 23,6 | 22,6 | 23,0 | 18,9 | 19,0 | 126 | | | |
| 130 | - | 13,7 | 9,5 | 23,4 | 23,5 | 20,5 | 19,6 | - | 21,0 | 21,5 | 20,8 | 21,3 | 20,2 | 20,7 | 16,4 | 16,5 | 130 | | | |
| 134 | - | 9,1 | 4,8 | 21,4 | 21,5 | 18,3 | 17,5 | - | 18,9 | 19,6 | 18,7 | 19,3 | 18,1 | 18,8 | 14,0 | 14,2 | 134 | | | |
| 135 | - | 7,9 | 3,6 | 21,0 | 21,0 | 17,8 | 17,0 | - | 18,4 | 19,1 | 18,2 | 18,8 | 17,6 | 18,3 | 13,4 | 13,6 | 135 | | | |
| 136 | - | 6,6 | - | 20,5 | 20,6 | 17,3 | 16,5 | - | 17,9 | 18,7 | 17,7 | 18,4 | 17,1 | 17,9 | 12,9 | 13,1 | 136 | | | |
| 138 | - | 4,5 | - | 19,6 | - | 16,3 | - | - | 17,0 | - | 16,8 | - | 16,2 | - | 11,9 | - | 138 | | | |
| 141 | - | - | - | 17,8 | - | 14,9 | - | - | 15,8 | - | 15,6 | - | 15,0 | - | 10,4 | - | 141 | | | |

0 t 65 t 95 t 125 t 165 t 205 t 265 t 325 t

LSL+LF_14: 225 t + 50 t

| 165 t + 50 t | | 8,40 m | | 9.8 m/s | | 360° | | ISO | | | | | | | |
|--------------|------|-----------|------|----------|------|-----------|------|-----------|------|-----------|-------|-------|-------|-------|-----|
| 150 m | | | | | | | | | | | | | | | |
| LSL+LF_4 | | LSL+LF_6 | | LSL+LF_8 | | LSL+LF_10 | | LSL+LF_12 | | LSL+LF_14 | | | | | |
| 12 m | | | | | | | | | | | | | | | |
| 0 t | | 0 t-325 t | | | | 0 t | | 0 t-325 t | | | | | | | |
| 15° | | 20° | | 15° | | 20° | | 15° | | 20° | | 15° | | 20° | |
| m | t | t | t | t | t | t | t | t | t | t | t | t | t | t | m |
| 19 | 69,0 | 72,0 | - | 79,5 | - | 73,0 | 91,0 | - | 96,0 | - | 104,0 | - | 119,0 | - | 19 |
| 20 | 66,0 | 71,5 | 70,0 | 79,0 | 78,0 | 68,5 | 91,0 | 89,5 | 96,0 | 94,5 | 104,0 | 102,0 | 119,0 | 116,0 | 20 |
| 22 | 59,2 | 71,2 | 69,5 | 79,0 | 78,0 | 61,2 | 90,7 | 89,5 | 95,7 | 94,0 | 103,5 | 102,0 | 119,0 | 116,0 | 22 |
| 24 | 52,5 | 71,0 | 69,0 | 79,0 | 77,5 | 54,0 | 90,5 | 89,0 | 95,5 | 94,0 | 103,0 | 102,0 | 119,0 | 116,0 | 24 |
| 26 | 47,3 | 70,5 | 69,0 | 78,7 | 77,5 | 48,4 | 90,2 | 89,0 | 95,2 | 94,0 | 103,0 | 102,0 | 118,5 | 115,0 | 26 |
| 28 | 42,2 | 70,0 | 68,5 | 78,5 | 77,0 | 42,8 | 90,0 | 89,0 | 95,0 | 93,5 | 103,0 | 101,0 | 118,0 | 114,0 | 28 |
| 30 | 37,9 | 69,5 | 68,0 | 78,2 | 77,0 | 38,2 | 90,0 | 88,5 | 94,5 | 93,0 | 102,5 | 101,0 | 117,5 | 111,0 | 30 |
| 34 | 30,2 | 68,2 | 67,0 | 77,5 | 76,3 | 29,8 | 89,7 | 88,1 | 93,5 | 91,6 | 101,5 | 100,0 | 116,5 | 105,5 | 34 |
| 38 | 23,9 | 67,0 | 65,8 | 76,6 | 75,6 | 23,1 | 88,8 | 87,5 | 92,1 | 90,1 | 100,3 | 99,0 | 115,5 | 101,0 | 38 |
| 42 | 18,3 | 66,0 | 64,5 | 76,0 | 75,0 | 17,1 | 87,5 | 86,5 | 90,5 | 88,5 | 99,0 | 98,0 | 114,0 | 97,0 | 42 |
| 46 | 13,9 | 64,6 | 63,5 | 75,0 | 74,3 | 12,3 | 85,8 | 84,8 | 88,1 | 85,6 | 97,0 | 94,6 | 112,0 | 93,0 | 46 |
| 50 | 9,9 | 63,3 | 62,3 | 74,0 | 73,3 | 8,0 | 84,2 | 83,0 | 85,2 | 82,6 | 93,6 | 92,1 | 108,6 | 89,3 | 50 |
| 54 | 6,3 | 62,0 | 61,0 | 72,5 | 72,0 | 4,2 | 82,5 | 81,5 | 83,0 | 80,0 | 91,5 | 88,0 | 105,0 | 86,0 | 54 |
| 57 | 4,0 | 61,0 | 59,9 | 71,7 | 71,2 | - | 81,2 | 80,0 | 80,2 | 78,0 | 88,7 | 86,2 | 102,0 | 83,7 | 57 |
| 58 | - | 60,6 | 59,6 | 71,5 | 71,0 | - | 80,8 | 79,6 | 79,6 | 77,3 | 88,1 | 85,6 | 102,0 | 83,0 | 58 |
| 62 | - | 59,3 | 58,3 | 70,3 | 69,0 | - | 79,1 | 77,3 | 77,1 | 73,8 | 85,1 | 81,6 | 95,6 | 80,3 | 62 |
| 66 | - | 58,0 | 57,0 | 69,0 | 68,0 | - | 77,5 | 76,0 | 74,5 | 71,5 | 82,5 | 79,0 | 89,1 | 77,8 | 66 |
| 70 | - | 55,8 | 55,1 | 67,1 | 66,0 | - | 75,1 | 73,3 | 71,6 | 67,6 | 80,1 | 75,3 | 82,5 | 75,5 | 70 |
| 74 | - | 53,8 | 53,5 | 65,6 | 64,5 | - | 73,1 | 71,3 | 68,6 | 65,3 | 76,0 | 72,6 | 76,1 | 73,1 | 74 |
| 78 | - | 52,5 | 51,5 | 64,0 | 62,5 | - | 70,5 | 69,0 | 66,0 | 63,5 | 70,0 | 70,0 | 70,2 | 70,0 | 78 |
| 82 | - | 50,6 | 50,1 | 60,2 | 59,3 | - | 65,1 | 65,6 | 63,7 | 61,6 | 64,6 | 65,1 | 64,5 | 65,5 | 82 |
| 86 | - | 49,4 | 48,8 | 56,0 | 55,3 | - | 60,0 | 60,5 | 60,1 | 59,3 | 59,4 | 60,0 | 59,1 | 60,1 | 86 |
| 90 | - | 48,3 | 47,6 | 52,0 | 51,0 | - | 55,0 | 55,5 | 55,5 | 56,0 | 54,5 | 55,0 | 54,0 | 54,8 | 90 |
| 94 | - | 46,9 | 46,3 | 47,8 | 47,0 | - | 50,8 | 51,1 | 50,8 | 51,4 | 50,0 | 50,4 | 49,5 | 50,0 | 94 |
| 98 | - | 45,3 | 45,0 | 43,8 | 42,9 | - | 46,6 | 46,8 | 46,6 | 46,9 | 45,7 | 45,9 | 45,1 | 45,5 | 98 |
| 102 | - | 43,1 | 43,4 | 40,1 | 38,9 | - | 42,5 | 42,7 | 42,5 | 42,7 | 41,5 | 41,7 | 41,0 | 41,4 | 102 |
| 106 | - | 39,8 | 40,0 | 36,5 | 35,5 | - | 38,7 | 38,9 | 38,7 | 38,9 | 37,7 | 37,8 | 37,2 | 37,7 | 106 |
| 110 | - | 36,7 | 37,0 | 33,2 | 32,4 | - | 35,0 | 35,2 | 35,0 | 35,2 | 34,0 | 34,1 | 33,8 | 34,2 | 110 |
| 114 | - | 33,9 | 34,1 | 30,2 | 29,4 | - | 31,6 | 31,8 | 31,6 | 31,8 | 30,6 | 30,7 | 30,6 | 30,9 | 114 |
| 118 | - | 31,3 | 31,5 | 27,4 | 26,6 | - | 28,5 | 28,8 | 28,5 | 28,7 | 27,4 | 27,6 | 27,6 | 27,8 | 118 |
| 122 | - | 28,8 | 29,0 | 24,8 | 23,9 | - | 25,6 | 25,9 | 25,6 | 25,8 | 24,5 | 24,7 | 24,8 | 24,9 | 122 |
| 126 | - | 26,6 | 26,7 | 22,3 | 21,4 | - | 22,9 | 23,3 | 22,8 | 23,2 | 21,8 | 22,1 | 22,0 | 22,1 | 126 |
| 130 | - | 24,5 | 24,6 | 19,9 | 19,1 | - | 20,5 | 21,0 | 20,4 | 20,8 | 19,4 | 19,8 | 19,5 | 19,7 | 130 |
| 134 | - | 22,6 | 22,7 | 17,7 | 16,9 | - | 18,3 | 18,9 | 18,2 | 18,7 | 17,3 | 17,7 | 17,2 | 17,3 | 134 |
| 138 | - | 20,8 | 20,9 | 15,7 | 14,9 | - | 16,3 | 17,0 | 16,2 | 16,9 | 15,3 | 15,9 | 15,0 | 15,2 | 138 |
| 140 | - | 19,9 | 16,1 | 14,7 | - | - | 15,4 | - | 15,3 | - | 14,4 | - | 14,0 | - | 140 |
| 142 | - | 19,0 | - | 13,8 | - | - | 14,6 | - | 14,5 | - | 13,6 | - | 13,0 | - | 142 |
| 143 | - | 18,5 | - | 13,4 | - | - | 14,2 | - | 14,1 | - | 13,2 | - | 12,5 | - | 143 |

0 t 65 t 95 t 125 t 165 t 205 t 265 t 325 t

LSL+LF_14: 225 t + 50 t

| 165 t + 50 t | | 8,40 m | | 9.8 m/s | | 360° | | ISO | | | | | | | | | | | | | | | |
|--------------|------|-----------|------|----------|------|------|------|-----------|------|------|------|-----------|-------|-------|-----|-----------|---|-----|---|-----------|--|--|--|
| 153 m | | | | | | | | | | | | | | | | | | | | | | | |
| LSL+LF_4 | | | | LSL+LF_6 | | | | LSL+LF_8 | | | | LSL+LF_10 | | | | LSL+LF_12 | | | | LSL+LF_14 | | | |
| 12 m | | | | | | | | | | | | | | | | | | | | | | | |
| 0 t | | 0 t-325 t | | | | 0 t | | 0 t-325 t | | | | | | | | 0 t | | | | | | | |
| 15° | | 20° | | 15° | | 20° | | 15° | | 20° | | 15° | | 20° | | 15° | | 20° | | | | | |
| m | t | t | t | t | t | t | t | t | t | t | t | t | t | t | t | t | t | t | m | | | | |
| 19 | 67,0 | 69,0 | - | 75,5 | - | 70,5 | 87,0 | - | 91,5 | - | 98,5 | - | 113,0 | - | 19 | | | | | | | | |
| 20 | 64,5 | 69,0 | 67,5 | 75,5 | 74,0 | 66,5 | 86,5 | - | 91,0 | - | 98,5 | - | 113,0 | - | 20 | | | | | | | | |
| 21 | 61,1 | 68,8 | 67,2 | 75,3 | 74,0 | 62,8 | 86,3 | 85,5 | 91,0 | 89,5 | 98,3 | 97,0 | 113,0 | 111,0 | 21 | | | | | | | | |
| 22 | 57,7 | 68,7 | 67,0 | 75,2 | 74,0 | 59,2 | 86,2 | 85,0 | 91,0 | 89,5 | 98,2 | 97,0 | 113,0 | 111,0 | 22 | | | | | | | | |
| 24 | 51,0 | 68,5 | 67,0 | 75,0 | 73,5 | 52,0 | 86,0 | 85,0 | 91,0 | 89,5 | 98,0 | 97,0 | 113,0 | 111,0 | 24 | | | | | | | | |
| 26 | 45,8 | 68,0 | 66,5 | 74,7 | 73,5 | 46,5 | 86,0 | 85,0 | 90,7 | 89,5 | 98,0 | 97,0 | 112,5 | 111,0 | 26 | | | | | | | | |
| 28 | 40,7 | 67,5 | 66,0 | 74,5 | 73,0 | 41,1 | 86,0 | 84,5 | 90,5 | 89,0 | 98,0 | 97,0 | 112,0 | 111,0 | 28 | | | | | | | | |
| 30 | 36,5 | 67,0 | 65,5 | 74,2 | 73,0 | 36,5 | 85,7 | 84,5 | 90,0 | 88,5 | 97,5 | 96,5 | 111,5 | 110,0 | 30 | | | | | | | | |
| 34 | 28,8 | 66,0 | 64,5 | 73,5 | 72,6 | 28,3 | 85,2 | 84,1 | 89,2 | 87,5 | 97,2 | 96,1 | 111,0 | 106,5 | 34 | | | | | | | | |
| 38 | 22,6 | 65,0 | 63,6 | 72,6 | 72,1 | 21,6 | 84,5 | 83,3 | 88,1 | 86,1 | 96,5 | 95,3 | 110,0 | 101,7 | 38 | | | | | | | | |
| 42 | 17,1 | 64,0 | 63,0 | 72,0 | 71,5 | 15,6 | 83,5 | 82,0 | 86,5 | 84,5 | 95,5 | 94,0 | 108,3 | 97,5 | 42 | | | | | | | | |
| 46 | 12,7 | 63,0 | 61,6 | 71,3 | 70,8 | 10,9 | 81,8 | 80,6 | 84,5 | 82,5 | 93,5 | 91,6 | 107,0 | 93,5 | 46 | | | | | | | | |
| 50 | 8,7 | 61,9 | 60,6 | 70,3 | 69,8 | 6,6 | 80,3 | 79,0 | 82,0 | 80,5 | 90,4 | 89,0 | 103,6 | 90,1 | 50 | | | | | | | | |
| 53 | 6,0 | 61,0 | 60,0 | 69,3 | 69,1 | 3,7 | 79,0 | 77,8 | 80,5 | 78,0 | 88,6 | 87,5 | 101,1 | 87,6 | 53 | | | | | | | | |
| 54 | 5,2 | 60,5 | 59,5 | 69,0 | 69,0 | - | 78,5 | 77,5 | 80,0 | 77,5 | 88,0 | 87,0 | 100,3 | 86,7 | 54 | | | | | | | | |
| 56 | 3,6 | 60,0 | 59,0 | 68,5 | 68,5 | - | 77,6 | 76,6 | 78,0 | 76,1 | 87,0 | 85,3 | 98,6 | 85,0 | 56 | | | | | | | | |
| 58 | - | 59,5 | 58,5 | 68,0 | 68,0 | - | 76,8 | 75,8 | 77,0 | 74,8 | 86,0 | 83,6 | 97,0 | 83,5 | 58 | | | | | | | | |
| 62 | - | 58,3 | 57,3 | 67,0 | 67,0 | - | 75,1 | 73,8 | 74,6 | 71,8 | 83,5 | 81,3 | 92,0 | 80,8 | 62 | | | | | | | | |
| 66 | - | 57,0 | 56,0 | 66,0 | 66,0 | - | 73,5 | 72,0 | 72,0 | 69,5 | 81,5 | 79,0 | 86,3 | 78,3 | 66 | | | | | | | | |
| 70 | - | 55,5 | 54,5 | 65,0 | 64,0 | - | 71,3 | 70,6 | 70,0 | 66,1 | 78,1 | 76,0 | 80,0 | 76,0 | 70 | | | | | | | | |
| 74 | - | 53,7 | 53,5 | 63,9 | 62,6 | - | 69,5 | 67,8 | 66,8 | 63,7 | 73,5 | 73,0 | 74,0 | 73,3 | 74 | | | | | | | | |
| 78 | - | 52,5 | 51,5 | 62,5 | 61,0 | - | 67,5 | 65,5 | 64,5 | 61,5 | 67,5 | 68,5 | 68,1 | 69,0 | 78 | | | | | | | | |
| 82 | - | 50,6 | 50,0 | 58,1 | 57,3 | - | 62,8 | 62,6 | 62,1 | 59,8 | 62,5 | 63,1 | 62,5 | 63,5 | 82 | | | | | | | | |
| 86 | - | 49,5 | 48,9 | 54,0 | 53,5 | - | 58,1 | 58,6 | 58,6 | 57,7 | 57,3 | 58,0 | 57,0 | 58,1 | 86 | | | | | | | | |
| 90 | - | 48,2 | 47,9 | 50,0 | 49,4 | - | 53,5 | 54,0 | 53,5 | 54,0 | 52,5 | 53,0 | 52,2 | 53,1 | 90 | | | | | | | | |
| 94 | - | 47,1 | 46,5 | 46,1 | 45,4 | - | 49,1 | 49,6 | 49,2 | 49,6 | 48,1 | 48,5 | 47,7 | 48,3 | 94 | | | | | | | | |
| 98 | - | 45,2 | 44,8 | 42,3 | 41,4 | - | 44,9 | 45,2 | 45,0 | 45,2 | 43,9 | 44,2 | 43,3 | 43,8 | 98 | | | | | | | | |
| 102 | - | 42,2 | 42,4 | 38,5 | 37,4 | - | 40,9 | 41,2 | 41,0 | 41,2 | 39,8 | 40,0 | 39,2 | 39,6 | 102 | | | | | | | | |
| 106 | - | 38,8 | 39,1 | 34,9 | 34,0 | - | 37,1 | 37,4 | 37,2 | 37,3 | 36,0 | 36,2 | 35,3 | 35,8 | 106 | | | | | | | | |
| 110 | - | 35,7 | 36,0 | 31,5 | 30,8 | - | 33,5 | 33,7 | 33,5 | 33,6 | 32,3 | 32,5 | 32,0 | 32,4 | 110 | | | | | | | | |
| 114 | - | 32,9 | 33,1 | 28,7 | 27,9 | - | 30,2 | 30,4 | 30,1 | 30,3 | 29,0 | 29,1 | 28,8 | 29,2 | 114 | | | | | | | | |
| 118 | - | 30,3 | 30,5 | 25,9 | 25,1 | - | 27,1 | 27,3 | 27,0 | 27,2 | 25,8 | 26,0 | 25,8 | 26,1 | 118 | | | | | | | | |
| 122 | - | 27,8 | 28,0 | 23,3 | 22,4 | - | 24,2 | 24,4 | 24,0 | 24,3 | 22,9 | 23,1 | 23,0 | 23,2 | 122 | | | | | | | | |
| 126 | - | 25,6 | 25,7 | 20,8 | 19,9 | - | 21,5 | 21,8 | 21,3 | 21,6 | 20,2 | 20,4 | 20,3 | 20,5 | 126 | | | | | | | | |
| 130 | - | 23,5 | 23,6 | 18,5 | 17,6 | - | 19,0 | 19,4 | 18,9 | 19,2 | 17,8 | 18,1 | 17,8 | 18,0 | 130 | | | | | | | | |
| 134 | - | 21,5 | 21,6 | 16,3 | 15,5 | - | 16,7 | 17,3 | 16,6 | 17,1 | 15,5 | 16,0 | 15,4 | 15,6 | 134 | | | | | | | | |
| 138 | - | 19,7 | 19,8 | 14,3 | 13,5 | - | 14,7 | 15,3 | 14,6 | 15,1 | 13,5 | 14,1 | 13,2 | 13,4 | 138 | | | | | | | | |
| 141 | - | 18,4 | 18,5 | 12,9 | 12,1 | - | 13,4 | 14,0 | 13,2 | 13,9 | 12,1 | 12,8 | 11,7 | 11,9 | 141 | | | | | | | | |
| 142 | - | 18,0 | 18,1 | 12,4 | - | - | 12,9 | - | 12,8 | - | 11,7 | - | 11,2 | - | 142 | | | | | | | | |
| 143 | - | 17,6 | 6,2 | 11,9 | - | - | 12,5 | - | 12,3 | - | 11,3 | - | 10,7 | - | 143 | | | | | | | | |
| 146 | - | 16,0 | - | 10,6 | - | - | 11,3 | - | 11,0 | - | 10,1 | - | 9,4 | - | 146 | | | | | | | | |

0 t 65 t 95 t 125 t 165 t 205 t 265 t 325 t

LSL+LF_14: 225 t + 50 t

| 165 t + 50 t | | 8,40 m | | 9.8 m/s | | 360° | | ISO | | | | | | | | | | | | | | | |
|--------------|------|-------------|------|----------|------|------|------|----------|------|-------------|------|-----------|-------|-------|-----|-----------|---|-----|---|-----------|--|--|--|
| 156 m | | | | | | | | | | | | | | | | | | | | | | | |
| LSL+LF_4 | | | | LSL+LF_6 | | | | LSL+LF_8 | | | | LSL+LF_10 | | | | LSL+LF_12 | | | | LSL+LF_14 | | | |
| 12 m | | | | | | | | | | | | | | | | | | | | | | | |
| 0 t | | 0 t - 325 t | | | | | | 0 t | | 0 t - 325 t | | | | | | 0 t | | | | | | | |
| 15° | | 20° | | 15° | | 20° | | 15° | | 20° | | 15° | | 20° | | 15° | | 20° | | | | | |
| m | t | t | t | t | t | t | t | t | t | t | t | t | t | t | t | t | t | t | m | | | | |
| 20 | 62,5 | 66,0 | - | 71,0 | - | 65,0 | 82,0 | - | 86,0 | - | 93,5 | - | 107,0 | - | 20 | | | | | | | | |
| 21 | 59,3 | 65,8 | 64,5 | 70,8 | 70,0 | 61,3 | 81,8 | 80,5 | 85,8 | 85,0 | 93,3 | 92,0 | 107,0 | 106,0 | 21 | | | | | | | | |
| 22 | 56,1 | 65,7 | 64,5 | 70,7 | 70,0 | 57,7 | 81,7 | 80,5 | 85,7 | 84,5 | 93,2 | 92,0 | 107,0 | 106,0 | 22 | | | | | | | | |
| 24 | 49,7 | 65,5 | 64,0 | 70,5 | 70,0 | 50,5 | 81,5 | 80,5 | 85,5 | 84,5 | 93,0 | 92,0 | 107,0 | 105,0 | 24 | | | | | | | | |
| 26 | 44,5 | 65,0 | 63,5 | 70,2 | 69,5 | 45,1 | 81,2 | 80,0 | 85,5 | 84,5 | 93,0 | 92,0 | 106,5 | 105,0 | 26 | | | | | | | | |
| 28 | 39,4 | 64,5 | 63,5 | 70,0 | 69,5 | 39,8 | 81,0 | 80,0 | 85,5 | 84,0 | 93,0 | 92,0 | 106,0 | 105,0 | 28 | | | | | | | | |
| 30 | 35,2 | 64,0 | 63,0 | 69,7 | 69,0 | 35,3 | 80,7 | 80,0 | 85,2 | 84,0 | 92,7 | 91,5 | 105,5 | 104,5 | 30 | | | | | | | | |
| 34 | 27,6 | 63,2 | 62,0 | 69,2 | 68,6 | 27,1 | 80,5 | 79,6 | 84,7 | 83,3 | 92,5 | 91,5 | 104,5 | 104,0 | 34 | | | | | | | | |
| 38 | 21,4 | 62,5 | 61,1 | 68,6 | 68,1 | 20,4 | 80,0 | 79,0 | 83,8 | 82,3 | 91,8 | 90,8 | 103,5 | 102,0 | 38 | | | | | | | | |
| 42 | 15,9 | 61,5 | 60,5 | 68,0 | 67,5 | 14,5 | 79,0 | 78,0 | 82,5 | 81,0 | 90,5 | 89,5 | 102,3 | 98,0 | 42 | | | | | | | | |
| 46 | 11,5 | 60,5 | 59,5 | 67,3 | 66,8 | 9,8 | 77,6 | 76,6 | 80,8 | 79,3 | 88,8 | 87,5 | 101,0 | 94,0 | 46 | | | | | | | | |
| 50 | 7,6 | 59,3 | 58,5 | 66,3 | 66,0 | 5,5 | 76,5 | 75,0 | 79,0 | 77,5 | 86,3 | 85,0 | 98,6 | 90,6 | 50 | | | | | | | | |
| 52 | 5,8 | 58,8 | 58,0 | 65,9 | 65,5 | 3,6 | 75,5 | 74,2 | 78,0 | 76,5 | 85,1 | 84,0 | 97,5 | 89,0 | 52 | | | | | | | | |
| 54 | 4,1 | 58,5 | 57,5 | 65,5 | 65,0 | - | 74,5 | 73,5 | 77,0 | 75,5 | 84,0 | 83,0 | 96,0 | 87,3 | 54 | | | | | | | | |
| 58 | - | 57,1 | 56,5 | 64,1 | 64,0 | - | 73,1 | 72,1 | 75,3 | 73,3 | 82,0 | 80,6 | 93,5 | 84,0 | 58 | | | | | | | | |
| 62 | - | 56,0 | 55,3 | 63,0 | 63,0 | - | 71,8 | 70,6 | 73,1 | 71,5 | 79,6 | 78,1 | 89,1 | 81,3 | 62 | | | | | | | | |
| 66 | - | 55,0 | 54,0 | 62,0 | 62,0 | - | 70,5 | 69,0 | 71,5 | 69,5 | 78,0 | 76,5 | 83,8 | 78,8 | 66 | | | | | | | | |
| 70 | - | 53,5 | 52,6 | 61,0 | 61,0 | - | 68,1 | 67,6 | 69,1 | 67,0 | 75,6 | 73,5 | 77,5 | 76,5 | 70 | | | | | | | | |
| 74 | - | 51,8 | 51,2 | 60,0 | 60,0 | - | 66,7 | 65,5 | 67,2 | 65,0 | 71,8 | 71,0 | 71,9 | 72,1 | 74 | | | | | | | | |
| 78 | - | 51,0 | 50,0 | 59,0 | 58,5 | - | 65,0 | 63,0 | 65,5 | 62,0 | 66,0 | 67,0 | 66,3 | 67,1 | 78 | | | | | | | | |
| 82 | - | 49,5 | 48,6 | 55,6 | 55,1 | - | 61,0 | 60,6 | 61,1 | 60,0 | 61,0 | 61,6 | 61,0 | 61,5 | 82 | | | | | | | | |
| 86 | - | 48,6 | 47,6 | 52,0 | 51,5 | - | 56,6 | 57,0 | 56,6 | 57,5 | 55,9 | 56,8 | 55,8 | 56,7 | 86 | | | | | | | | |
| 90 | - | 47,2 | 46,6 | 48,5 | 47,8 | - | 52,0 | 52,5 | 52,0 | 52,5 | 51,5 | 52,0 | 51,1 | 51,7 | 90 | | | | | | | | |
| 94 | - | 46,1 | 45,2 | 44,6 | 43,9 | - | 47,8 | 48,2 | 47,8 | 48,2 | 47,0 | 47,4 | 46,5 | 47,2 | 94 | | | | | | | | |
| 98 | - | 44,2 | 43,7 | 40,9 | 40,1 | - | 43,7 | 44,0 | 43,7 | 44,0 | 42,8 | 43,1 | 42,3 | 42,8 | 98 | | | | | | | | |
| 102 | - | 41,2 | 41,5 | 37,3 | 36,3 | - | 39,7 | 40,0 | 39,7 | 39,9 | 38,8 | 39,0 | 38,2 | 38,6 | 102 | | | | | | | | |
| 106 | - | 37,9 | 38,2 | 33,7 | 32,7 | - | 36,0 | 36,2 | 35,9 | 36,1 | 35,0 | 35,2 | 34,4 | 34,7 | 106 | | | | | | | | |
| 110 | - | 34,8 | 35,1 | 30,4 | 29,5 | - | 32,4 | 32,6 | 32,3 | 32,5 | 31,4 | 31,6 | 31,0 | 31,4 | 110 | | | | | | | | |
| 114 | - | 32,0 | 32,2 | 27,4 | 26,6 | - | 29,1 | 29,3 | 29,0 | 29,2 | 28,0 | 28,2 | 27,9 | 28,2 | 114 | | | | | | | | |
| 118 | - | 29,3 | 29,5 | 24,6 | 23,8 | - | 26,0 | 26,2 | 25,9 | 26,1 | 24,8 | 25,0 | 24,9 | 25,2 | 118 | | | | | | | | |
| 122 | - | 26,9 | 27,1 | 22,0 | 21,1 | - | 23,1 | 23,3 | 23,0 | 23,1 | 22,0 | 22,1 | 22,1 | 22,3 | 122 | | | | | | | | |
| 126 | - | 24,6 | 24,8 | 19,6 | 18,7 | - | 20,4 | 20,7 | 20,2 | 20,5 | 19,2 | 19,5 | 19,4 | 19,7 | 126 | | | | | | | | |
| 130 | - | 22,5 | 22,7 | 17,3 | 16,4 | - | 17,9 | 18,3 | 17,8 | 18,1 | 16,7 | 17,1 | 16,9 | 17,1 | 130 | | | | | | | | |
| 134 | - | 20,6 | 20,7 | 15,1 | 14,2 | - | 15,6 | 16,0 | 15,5 | 15,9 | 14,4 | 14,9 | 14,6 | 14,7 | 134 | | | | | | | | |
| 138 | - | 18,7 | 18,9 | 13,1 | 12,2 | - | 13,5 | 14,0 | 13,4 | 13,9 | 12,4 | 12,9 | 12,4 | 12,5 | 138 | | | | | | | | |
| 142 | - | 15,5 | 17,2 | 11,1 | 10,3 | - | 11,6 | 12,3 | 11,5 | 12,1 | 10,6 | 11,2 | 10,3 | 10,5 | 142 | | | | | | | | |
| 143 | - | 14,7 | 16,8 | 10,6 | 9,9 | - | 11,2 | 11,9 | 11,1 | 11,7 | 10,1 | 10,8 | 9,8 | 10,0 | 143 | | | | | | | | |
| 145 | - | 13,2 | 16,0 | 9,7 | - | - | 10,4 | - | 10,2 | - | 9,3 | - | 8,9 | - | 145 | | | | | | | | |
| 146 | - | 12,4 | - | 9,3 | - | - | 10,0 | - | 9,8 | - | 8,9 | - | 8,4 | - | 146 | | | | | | | | |
| 148 | - | 11,0 | - | 8,5 | - | - | 9,2 | - | 8,9 | - | 8,2 | - | 7,5 | - | 148 | | | | | | | | |





0t 65t 95t 125t 165t 205t 265t 325t

LSL+LF_14: 225t + 50t



| 165 t + 50 t | | 8,40 m | | 9.8 m/s | | 360° | | ISO | | | | | | | | | | | | | | | |
|--------------|------|-----------|------|----------|------|------|------|-----------|------|------|------|-----------|-------|-------|-----|-----------|---|-----|---|-----------|--|--|--|
| 159 m | | | | | | | | | | | | | | | | | | | | | | | |
| LSL+LF_4 | | | | LSL+LF_6 | | | | LSL+LF_8 | | | | LSL+LF_10 | | | | LSL+LF_12 | | | | LSL+LF_14 | | | |
| 12 m | | | | | | | | | | | | | | | | | | | | | | | |
| 0 t | | 0 t-325 t | | | | 0 t | | 0 t-325 t | | | | | | | | 0 t | | | | | | | |
| 15° | | 20° | | 15° | | 20° | | 15° | | 20° | | 15° | | 20° | | 15° | | 20° | | | | | |
| m | t | t | t | t | t | t | t | t | t | t | t | t | t | t | t | t | t | t | m | | | | |
| 20 | 61,0 | 63,0 | - | 67,5 | - | 63,0 | 78,5 | - | 82,0 | - | 89,0 | - | 102,0 | - | 20 | | | | | | | | |
| 21 | 57,7 | 62,8 | 62,0 | 67,3 | 66,5 | 59,5 | 78,2 | 77,0 | 81,8 | 81,0 | 88,8 | 87,5 | 102,0 | 100,0 | 21 | | | | | | | | |
| 22 | 54,5 | 62,7 | 62,0 | 67,2 | 66,5 | 56,0 | 78,0 | 77,0 | 81,7 | 80,5 | 88,7 | 87,5 | 102,0 | 100,0 | 22 | | | | | | | | |
| 24 | 48,1 | 62,5 | 61,5 | 67,0 | 66,5 | 49,1 | 77,5 | 76,5 | 81,5 | 80,5 | 88,5 | 87,5 | 101,0 | 100,0 | 24 | | | | | | | | |
| 26 | 43,0 | 62,2 | 61,5 | 66,7 | 66,0 | 43,6 | 77,5 | 76,5 | 81,2 | 80,0 | 88,5 | 87,5 | 101,0 | 100,0 | 26 | | | | | | | | |
| 28 | 37,9 | 62,0 | 61,0 | 66,5 | 66,0 | 38,1 | 77,5 | 76,5 | 81,0 | 80,0 | 88,5 | 87,5 | 101,0 | 100,0 | 28 | | | | | | | | |
| 30 | 33,8 | 61,7 | 60,5 | 66,2 | 65,5 | 33,6 | 77,2 | 76,0 | 80,7 | 80,0 | 88,2 | 87,0 | 100,5 | 99,5 | 30 | | | | | | | | |
| 34 | 26,3 | 61,0 | 59,8 | 65,7 | 65,1 | 25,5 | 76,7 | 75,6 | 80,2 | 79,0 | 87,7 | 86,6 | 99,5 | 98,7 | 34 | | | | | | | | |
| 38 | 20,1 | 60,1 | 59,1 | 65,1 | 64,6 | 18,9 | 76,0 | 74,8 | 79,5 | 78,0 | 87,0 | 85,8 | 99,0 | 98,0 | 38 | | | | | | | | |
| 42 | 14,7 | 59,5 | 58,5 | 64,5 | 64,0 | 13,1 | 75,0 | 73,5 | 78,5 | 77,0 | 86,0 | 84,5 | 97,8 | 96,5 | 42 | | | | | | | | |
| 46 | 10,3 | 58,5 | 57,5 | 63,8 | 63,3 | 8,4 | 73,6 | 72,1 | 77,2 | 75,3 | 85,0 | 83,5 | 96,5 | 94,5 | 46 | | | | | | | | |
| 50 | 6,4 | 57,5 | 56,6 | 63,0 | 62,5 | 4,1 | 72,1 | 70,7 | 75,0 | 73,5 | 82,0 | 80,6 | 94,1 | 91,1 | 50 | | | | | | | | |
| 53 | 3,7 | 56,7 | 56,1 | 62,2 | 61,7 | - | 70,9 | 69,8 | 73,5 | 72,0 | 80,5 | 79,0 | 92,5 | 88,7 | 53 | | | | | | | | |
| 54 | - | 56,5 | 56,0 | 62,0 | 61,5 | - | 70,5 | 69,5 | 73,0 | 71,5 | 80,0 | 78,5 | 91,8 | 88,0 | 54 | | | | | | | | |
| 58 | - | 55,8 | 55,0 | 61,0 | 60,5 | - | 68,8 | 67,8 | 71,3 | 69,5 | 77,8 | 76,5 | 89,0 | 85,0 | 58 | | | | | | | | |
| 62 | - | 55,0 | 54,0 | 60,0 | 59,6 | - | 67,3 | 66,6 | 69,5 | 67,5 | 76,0 | 73,5 | 85,6 | 82,0 | 62 | | | | | | | | |
| 66 | - | 54,0 | 53,0 | 59,0 | 59,0 | - | 66,0 | 64,0 | 67,5 | 65,5 | 74,0 | 71,5 | 81,0 | 79,0 | 66 | | | | | | | | |
| 70 | - | 52,7 | 52,0 | 58,0 | 58,3 | - | 63,9 | 61,8 | 65,8 | 63,0 | 71,8 | 69,0 | 75,0 | 76,0 | 70 | | | | | | | | |
| 74 | - | 51,0 | 50,5 | 57,0 | 57,5 | - | 62,0 | 60,0 | 64,0 | 60,8 | 69,2 | 66,9 | 69,1 | 70,4 | 74 | | | | | | | | |
| 78 | - | 50,0 | 49,7 | 56,0 | 56,0 | - | 60,5 | 58,0 | 62,0 | 58,5 | 64,0 | 64,5 | 63,8 | 64,8 | 78 | | | | | | | | |
| 82 | - | 48,9 | 48,3 | 53,3 | 53,0 | - | 58,1 | 56,0 | 59,2 | 56,5 | 58,8 | 59,5 | 58,5 | 59,5 | 82 | | | | | | | | |
| 86 | - | 48,1 | 47,5 | 50,1 | 49,6 | - | 54,8 | 53,8 | 54,6 | 54,1 | 54,2 | 54,6 | 53,9 | 54,6 | 86 | | | | | | | | |
| 90 | - | 46,7 | 46,4 | 46,5 | 45,9 | - | 50,5 | 51,0 | 50,0 | 50,5 | 49,7 | 50,0 | 49,1 | 49,8 | 90 | | | | | | | | |
| 94 | - | 45,8 | 45,2 | 42,8 | 42,1 | - | 46,2 | 46,6 | 46,1 | 46,5 | 45,3 | 45,7 | 44,6 | 45,4 | 94 | | | | | | | | |
| 98 | - | 43,6 | 43,4 | 39,2 | 38,4 | - | 42,1 | 42,5 | 42,0 | 42,3 | 41,2 | 41,5 | 40,4 | 41,0 | 98 | | | | | | | | |
| 102 | - | 40,3 | 40,5 | 35,6 | 34,7 | - | 38,2 | 38,5 | 38,0 | 38,3 | 37,2 | 37,4 | 36,4 | 36,9 | 102 | | | | | | | | |
| 106 | - | 36,9 | 37,2 | 32,1 | 31,0 | - | 34,5 | 34,8 | 34,3 | 34,5 | 33,4 | 33,6 | 32,6 | 32,9 | 106 | | | | | | | | |
| 110 | - | 33,8 | 34,1 | 28,8 | 27,9 | - | 31,0 | 31,3 | 30,8 | 31,0 | 29,9 | 30,0 | 29,2 | 29,6 | 110 | | | | | | | | |
| 114 | - | 31,0 | 31,2 | 25,7 | 25,0 | - | 27,7 | 27,9 | 27,4 | 27,6 | 26,5 | 26,6 | 26,0 | 26,4 | 114 | | | | | | | | |
| 118 | - | 28,3 | 28,5 | 23,0 | 22,3 | - | 24,5 | 24,8 | 24,3 | 24,5 | 23,3 | 23,5 | 23,1 | 23,4 | 118 | | | | | | | | |
| 122 | - | 25,9 | 26,1 | 20,5 | 19,6 | - | 21,7 | 21,9 | 21,4 | 21,6 | 20,5 | 20,6 | 20,3 | 20,6 | 122 | | | | | | | | |
| 126 | - | 23,6 | 23,8 | 18,1 | 17,2 | - | 19,0 | 19,2 | 18,7 | 18,9 | 17,7 | 17,9 | 17,7 | 17,9 | 126 | | | | | | | | |
| 130 | - | 21,5 | 21,6 | 15,8 | 14,9 | - | 16,5 | 16,8 | 16,2 | 16,5 | 15,2 | 15,5 | 15,2 | 15,4 | 130 | | | | | | | | |
| 134 | - | 19,3 | 19,5 | 13,6 | 12,7 | - | 14,1 | 13,9 | 13,8 | 14,2 | 12,8 | 13,2 | 12,4 | 12,4 | 134 | | | | | | | | |
| 138 | - | 16,9 | 17,3 | 11,6 | 10,7 | - | 12,0 | 10,7 | 11,7 | 11,8 | 10,7 | 11,2 | 9,6 | 9,7 | 138 | | | | | | | | |
| 142 | - | 13,3 | 14,4 | 9,7 | 8,9 | - | 8,5 | 6,5 | 9,0 | 7,6 | 8,8 | 9,4 | 7,0 | 7,2 | 142 | | | | | | | | |
| 145 | - | 11,0 | 12,1 | 8,3 | 7,6 | - | 5,8 | 3,5 | 6,7 | 4,6 | 7,5 | 8,2 | 5,3 | 5,6 | 145 | | | | | | | | |
| 146 | - | 10,7 | - | 7,9 | - | - | 4,8 | - | 5,8 | - | 7,1 | - | 4,8 | - | 146 | | | | | | | | |
| 147 | - | 9,8 | - | 7,5 | - | - | 3,9 | - | 4,8 | - | 6,7 | - | 4,2 | - | 147 | | | | | | | | |
| 148 | - | 8,9 | - | 7,1 | - | - | - | - | 3,9 | - | 6,3 | - | 3,7 | - | 148 | | | | | | | | |
| 150 | - | 7,2 | - | 6,3 | - | - | - | - | - | - | 5,6 | - | - | - | 150 | | | | | | | | |
| 151 | - | 6,3 | - | 5,9 | - | - | - | - | - | - | 5,3 | - | - | - | 151 | | | | | | | | |

0 t 65 t 95 t 125 t 165 t 205 t 265 t 325 t

LSL+LF_14: 225 t + 50 t

|  165 t +  50 t  8,40 m  9.8 m/s 360° ISO | | | | | | | | | | | | | | | |
|---|------|------|------|------|------|------|------|------|------|------|------|------|------|------|-----|
| 162 m 165 m | | | | | | | | | | | | | | | |
| LSL+LF_10 LSL+LF_12 LSL+LF_14 LSL+LF_10 LSL+LF_12 LSL+LF_14 | | | | | | | | | | | | | | | |
| 12 m | | | | | | | | | | | | | | | |
| 0 t 0 t - 325 t 0 t 0 t - 325 t | | | | | | | | | | | | | | | |
| 15° 20° 15° 20° 15° 20° 15° 20° 15° 20° 15° 20° | | | | | | | | | | | | | | | |
| m | t | t | t | t | t | t | t | t | t | t | t | t | t | t | m |
| 20 | 61,0 | 77,5 | - | 84,0 | - | 97,5 | - | 59,0 | 73,5 | - | 80,0 | - | 92,5 | - | 20 |
| 21 | 57,6 | 77,3 | 76,5 | 83,8 | 82,5 | 97,5 | 96,5 | 55,6 | 73,3 | - | 79,8 | - | 92,5 | - | 21 |
| 22 | 54,3 | 77,2 | 76,5 | 83,7 | 82,5 | 97,5 | 96,5 | 52,3 | 73,2 | 72,5 | 79,7 | 79,0 | 92,5 | 91,5 | 22 |
| 24 | 47,6 | 77,0 | 76,0 | 83,5 | 82,5 | 97,0 | 96,0 | 45,7 | 73,0 | 72,5 | 79,5 | 78,5 | 92,0 | 91,0 | 24 |
| 26 | 42,1 | 76,7 | 76,0 | 83,2 | 82,0 | 96,7 | 95,7 | 40,3 | 72,7 | 72,0 | 79,5 | 78,5 | 91,7 | 90,7 | 26 |
| 28 | 36,7 | 76,5 | 76,0 | 83,0 | 82,0 | 96,5 | 95,5 | 35,0 | 72,5 | 72,0 | 79,5 | 78,5 | 91,5 | 90,5 | 28 |
| 30 | 32,3 | 76,5 | 75,5 | 82,7 | 82,0 | 96,0 | 95,2 | 30,6 | 72,5 | 71,5 | 79,0 | 78,0 | 91,0 | 90,2 | 30 |
| 34 | 24,3 | 76,2 | 74,8 | 82,2 | 81,3 | 95,2 | 94,5 | 22,7 | 72,2 | 71,1 | 78,0 | 77,0 | 90,2 | 89,5 | 34 |
| 38 | 17,7 | 75,5 | 74,0 | 81,5 | 80,5 | 94,5 | 93,5 | 16,2 | 71,5 | 70,5 | 76,8 | 75,6 | 89,5 | 88,7 | 38 |
| 42 | 11,9 | 74,5 | 73,0 | 80,5 | 79,5 | 93,5 | 92,5 | 10,4 | 70,5 | 69,5 | 75,5 | 74,0 | 88,5 | 87,8 | 42 |
| 46 | 7,3 | 73,3 | 71,8 | 79,0 | 78,0 | 92,5 | 91,5 | 5,8 | 69,5 | 68,5 | 74,0 | 72,5 | 87,5 | 87,0 | 46 |
| 48 | 5,0 | 72,5 | 71,5 | 78,5 | 77,5 | 91,5 | 90,1 | 3,6 | 69,0 | 68,0 | 73,0 | 71,5 | 86,7 | 86,0 | 48 |
| 49 | 4,0 | 72,0 | 70,8 | 77,9 | 76,0 | 91,0 | 89,5 | - | 68,5 | 67,5 | 72,0 | 70,6 | 86,3 | 85,5 | 49 |
| 50 | - | 71,6 | 70,3 | 77,3 | 75,6 | 90,5 | 88,8 | - | 68,1 | 67,1 | 71,5 | 70,0 | 85,9 | 85,0 | 50 |
| 54 | - | 70,0 | 69,0 | 75,0 | 74,0 | 88,1 | 86,3 | - | 66,5 | 65,5 | 69,5 | 68,0 | 84,0 | 82,6 | 54 |
| 58 | - | 68,3 | 67,3 | 73,0 | 71,3 | 85,5 | 83,5 | - | 65,1 | 64,1 | 66,6 | 65,6 | 82,0 | 80,0 | 58 |
| 62 | - | 66,6 | 65,3 | 71,0 | 69,3 | 83,1 | 80,5 | - | 63,8 | 62,8 | 64,3 | 62,8 | 79,6 | 77,6 | 62 |
| 66 | - | 65,0 | 64,0 | 69,0 | 67,0 | 79,1 | 77,3 | - | 62,5 | 61,5 | 62,0 | 60,5 | 75,9 | 74,8 | 66 |
| 70 | - | 63,4 | 61,8 | 67,0 | 64,8 | 73,5 | 74,0 | - | 60,6 | 60,0 | 58,7 | 58,2 | 70,5 | 71,5 | 70 |
| 74 | - | 61,2 | 59,8 | 65,1 | 62,0 | 67,8 | 68,8 | - | 58,8 | 57,8 | 56,5 | 55,3 | 65,1 | 66,1 | 74 |
| 78 | - | 60,0 | 58,0 | 63,5 | 60,0 | 62,5 | 63,5 | - | 57,5 | 56,5 | 54,0 | 53,0 | 60,0 | 61,0 | 78 |
| 82 | - | 57,6 | 55,6 | 58,5 | 57,6 | 57,5 | 58,5 | - | 55,6 | 54,5 | 50,8 | 50,0 | 55,0 | 56,0 | 82 |
| 86 | - | 54,2 | 53,0 | 53,8 | 54,3 | 52,8 | 53,4 | - | 51,9 | 51,8 | 48,0 | 48,1 | 50,6 | 51,5 | 86 |
| 90 | - | 49,7 | 50,0 | 49,6 | 50,0 | 48,2 | 48,9 | - | 47,8 | 48,4 | 44,8 | 46,0 | 46,2 | 47,1 | 90 |
| 94 | - | 45,5 | 45,9 | 45,3 | 45,8 | 43,8 | 44,5 | - | 43,6 | 44,2 | 41,6 | 43,4 | 41,8 | 42,7 | 94 |
| 98 | - | 41,4 | 41,9 | 41,2 | 41,6 | 39,6 | 40,3 | - | 39,6 | 40,1 | 38,3 | 40,1 | 37,7 | 38,5 | 98 |
| 102 | - | 37,5 | 37,9 | 37,3 | 37,6 | 35,6 | 36,1 | - | 35,8 | 36,2 | 35,1 | 36,1 | 33,9 | 34,4 | 102 |
| 106 | - | 33,9 | 34,1 | 33,6 | 33,8 | 31,9 | 32,2 | - | 32,2 | 32,5 | 31,9 | 32,4 | 30,1 | 30,5 | 106 |
| 110 | - | 30,4 | 30,6 | 30,1 | 30,3 | 28,3 | 28,8 | - | 28,7 | 29,0 | 28,5 | 28,9 | 26,6 | 27,0 | 110 |
| 114 | - | 27,1 | 27,3 | 26,8 | 26,9 | 25,1 | 25,6 | - | 25,5 | 25,7 | 25,1 | 25,5 | 23,4 | 23,7 | 114 |
| 118 | - | 23,9 | 24,1 | 23,6 | 23,8 | 22,2 | 22,6 | - | 22,4 | 22,6 | 20,3 | 21,7 | 20,4 | 20,9 | 118 |
| 122 | - | 21,1 | 21,3 | 20,8 | 20,9 | 19,5 | 19,8 | - | 19,5 | 19,7 | 15,9 | 17,3 | 17,0 | 17,7 | 122 |
| 126 | - | 18,3 | 18,5 | 18,0 | 18,2 | 16,6 | 16,9 | - | 16,8 | 17,0 | 11,8 | 12,5 | 13,6 | 14,3 | 126 |
| 130 | - | 15,8 | 16,0 | 15,4 | 15,7 | 13,6 | 13,8 | - | 14,2 | 14,5 | 8,1 | 8,3 | 10,2 | 10,6 | 130 |
| 134 | - | 13,4 | 13,7 | 13,0 | 13,3 | 10,4 | 10,5 | - | 11,9 | 12,1 | 4,7 | 4,5 | 7,2 | 7,4 | 134 |
| 135 | - | 12,8 | 13,1 | 12,5 | 12,8 | 9,7 | 9,7 | - | 11,3 | 11,6 | 3,9 | 3,7 | 6,4 | 6,6 | 135 |
| 138 | - | 11,2 | 11,6 | 10,9 | 11,3 | 7,6 | 7,7 | - | 9,7 | 10,0 | - | - | 4,3 | 4,4 | 138 |
| 139 | - | 10,7 | 10,9 | 10,3 | 10,7 | 7,0 | 7,0 | - | 9,2 | 9,1 | - | - | 3,7 | 3,7 | 139 |
| 142 | - | 9,3 | 9,0 | 8,5 | 9,1 | 5,0 | 5,1 | - | 7,7 | 6,6 | - | - | - | - | 142 |
| 144 | - | 8,4 | 7,7 | 7,4 | 8,0 | 3,8 | 4,0 | - | 6,7 | 5,0 | - | - | - | - | 144 |
| 145 | - | 7,6 | 6,7 | 6,7 | 7,3 | - | - | - | 5,8 | 4,0 | - | - | - | - | 145 |
| 146 | - | 6,9 | 5,8 | 6,1 | 6,6 | - | - | - | 5,0 | - | - | - | - | - | 146 |
| 147 | - | 6,1 | 4,8 | 5,5 | 5,9 | - | - | - | 4,2 | - | - | - | - | - | 147 |
| 148 | - | 5,4 | 3,9 | 4,9 | 5,2 | - | - | - | - | - | - | - | - | - | 148 |
| 150 | - | 3,9 | - | 3,7 | - | - | - | - | - | - | - | - | - | - | 150 |

0 t
65 t
95 t
125 t
165 t
205 t
265 t
325 t

LSL+LF_14:  225 t +  50 t

| 225 t + 50 t | | 8,40 m | | 9.8 m/s | | 360° | | ISO | | | | | | | |
|--------------|-------|---------|------|---------|------|---------|-------|-------|-------|---------|------|-------|------|---------|------|
| 126 m | | 129 m | | 132 m | | 135 m | | 138 m | | 141 m | | 144 m | | | |
| LSL+LF_14 | | | | | | | | | | | | | | | |
| 18 m | | | | | | | | | | | | | | | |
| 0 t | | 0t-325t | | 0 t | | 0t-325t | | 0 t | | 0t-325t | | 0 t | | 0t-325t | |
| 15° | | 20° | | 15° | | 20° | | 15° | | 20° | | 15° | | 20° | |
| m | t | t | t | t | t | t | t | t | t | t | t | t | t | t | t |
| 19 | 101,0 | 119,0 | - | 120,0 | - | - | - | - | - | - | - | - | - | - | - |
| 20 | 95,5 | 117,0 | - | 118,0 | - | 91,5 | 118,0 | - | 119,0 | - | 87,5 | 118,0 | - | 117,0 | - |
| 21 | 90,5 | 114,5 | 82,5 | 115,5 | 83,0 | 86,7 | 115,5 | 83,0 | 116,5 | - | 82,7 | 116,5 | - | 117,0 | - |
| 22 | 85,5 | 112,0 | 81,0 | 113,0 | 81,5 | 82,0 | 113,0 | 82,0 | 114,0 | 82,0 | 78,0 | 115,0 | 82,5 | 115,0 | 82,5 |
| 24 | 77,0 | 108,0 | 78,5 | 108,0 | 79,0 | 73,5 | 109,0 | 79,5 | 110,0 | 79,5 | 69,5 | 110,0 | 80,0 | 111,0 | 80,0 |
| 26 | 69,7 | 104,0 | 76,2 | 104,5 | 76,7 | 66,5 | 105,0 | 77,2 | 106,0 | 77,2 | 62,7 | 106,5 | 77,7 | 107,0 | 78,0 |
| 28 | 62,5 | 100,0 | 74,0 | 101,0 | 74,5 | 59,5 | 101,0 | 75,0 | 102,0 | 75,0 | 56,0 | 103,0 | 75,5 | 103,0 | 76,0 |
| 30 | 57,0 | 96,5 | 72,0 | 97,5 | 72,5 | 54,0 | 97,7 | 73,0 | 98,7 | 73,0 | 50,7 | 99,5 | 73,5 | 100,0 | 74,0 |
| 34 | 46,8 | 90,2 | 68,2 | 91,0 | 68,5 | 44,0 | 91,7 | 69,0 | 92,5 | 69,2 | 40,9 | 93,2 | 69,7 | 94,0 | 70,2 |
| 38 | 38,3 | 84,7 | 64,7 | 85,5 | 65,0 | 35,6 | 86,2 | 65,5 | 87,0 | 66,0 | 32,6 | 87,7 | 66,2 | 88,5 | 66,7 |
| 42 | 31,3 | 79,8 | 61,5 | 80,6 | 62,0 | 28,7 | 81,3 | 62,5 | 82,1 | 63,0 | 25,8 | 82,8 | 63,1 | 83,6 | 63,6 |
| 46 | 25,0 | 75,5 | 58,5 | 76,0 | 59,0 | 22,6 | 77,0 | 59,5 | 77,5 | 60,0 | 19,8 | 78,5 | 60,5 | 79,0 | 61,0 |
| 50 | 20,0 | 71,5 | 56,1 | 72,3 | 56,6 | 17,6 | 73,0 | 57,1 | 73,8 | 57,6 | 14,9 | 74,5 | 57,8 | 75,0 | 58,3 |
| 54 | 15,4 | 67,8 | 53,8 | 68,8 | 54,3 | 13,1 | 69,3 | 54,8 | 70,3 | 55,3 | 10,5 | 70,8 | 55,5 | 71,3 | 56,0 |
| 58 | 11,4 | 64,5 | 51,5 | 65,5 | 52,0 | 9,1 | 66,0 | 52,5 | 67,0 | 53,0 | 6,5 | 67,5 | 53,5 | 68,0 | 54,0 |
| 61 | 8,5 | 62,5 | 50,3 | 63,2 | 50,7 | 6,3 | 64,0 | 51,2 | 64,7 | 51,5 | 3,8 | 65,5 | 52,0 | 66,1 | 52,5 |
| 62 | 7,5 | 61,8 | 49,9 | 62,5 | 50,3 | 5,3 | 63,3 | 50,8 | 64,0 | 51,0 | - | 64,6 | 51,5 | 65,4 | 52,0 |
| 64 | 5,6 | 60,5 | 49,1 | 61,0 | 49,5 | 3,5 | 62,0 | 50,0 | 62,5 | 50,0 | - | 63,0 | 50,5 | 64,0 | 51,0 |
| 66 | 3,7 | 59,0 | 48,2 | 59,8 | 48,6 | - | 60,6 | 49,0 | 61,3 | 49,2 | - | 61,8 | 49,7 | 62,6 | 50,2 |
| 70 | - | 57,0 | 46,6 | 57,5 | 47,0 | - | 58,0 | 47,4 | 59,0 | 47,8 | - | 59,5 | 48,2 | 60,0 | 48,6 |
| 74 | - | 54,6 | 45,1 | 55,1 | 45,5 | - | 56,0 | 45,9 | 56,6 | 46,3 | - | 57,1 | 46,7 | 57,6 | 47,1 |
| 78 | - | 52,5 | 43,7 | 53,1 | 44,1 | - | 54,0 | 44,5 | 54,5 | 44,9 | - | 55,0 | 45,3 | 55,6 | 45,7 |
| 82 | - | 50,5 | 42,4 | 51,5 | 42,8 | - | 52,0 | 43,2 | 52,5 | 43,6 | - | 53,0 | 44,0 | 54,0 | 44,4 |
| 86 | - | 49,3 | 41,3 | 49,9 | 41,6 | - | 50,5 | 42,0 | 50,7 | 42,4 | - | 51,5 | 42,8 | 52,0 | 43,2 |
| 90 | - | 47,7 | 40,2 | 48,3 | 40,6 | - | 48,8 | 40,9 | 49,3 | 41,3 | - | 49,8 | 41,7 | 50,5 | 42,0 |
| 94 | - | 46,3 | 39,2 | 46,8 | 39,6 | - | 47,4 | 39,9 | 48,0 | 40,3 | - | 48,5 | 40,6 | 49,0 | 41,0 |
| 98 | - | 45,0 | 38,3 | 45,5 | 38,7 | - | 46,0 | 39,0 | 46,6 | 39,3 | - | 47,0 | 39,6 | 46,2 | 40,0 |
| 102 | - | 43,8 | 37,5 | 44,3 | 37,8 | - | 44,5 | 38,2 | 44,3 | 38,5 | - | 44,2 | 38,8 | 42,7 | 39,1 |
| 106 | - | 42,7 | 36,8 | 43,2 | 37,1 | - | 42,8 | 37,4 | 41,1 | 37,7 | - | 40,2 | 38,0 | 38,3 | 38,3 |
| 110 | - | 41,0 | 36,1 | 40,0 | 36,4 | - | 39,2 | 36,7 | 37,5 | 36,6 | - | 36,8 | 36,2 | 34,9 | 35,1 |
| 114 | - | 38,5 | 35,5 | 36,8 | 35,3 | - | 35,9 | 35,2 | 34,2 | 34,5 | - | 33,5 | 33,8 | 31,6 | 32,0 |
| 118 | - | 35,3 | 35,1 | 33,6 | 33,8 | - | 32,7 | 32,9 | 31,0 | 31,3 | - | 30,3 | 30,6 | 28,5 | 28,9 |
| 122 | - | 32,4 | 32,5 | 30,7 | 30,8 | - | 29,7 | 29,9 | 28,0 | 28,3 | - | 27,4 | 27,7 | 25,7 | 25,9 |
| 124 | - | 31,0 | 31,2 | 29,3 | 29,4 | - | 28,3 | 28,5 | 26,6 | 26,9 | - | 26,0 | 26,3 | 24,3 | 24,5 |
| 126 | - | 29,7 | - | 27,9 | 28,1 | - | 27,0 | 27,2 | 25,3 | 25,6 | - | 24,7 | 25,0 | 22,9 | 23,2 |
| 127 | - | 29,0 | - | 27,3 | 27,5 | - | 26,3 | 26,5 | 24,6 | 24,9 | - | 24,0 | 24,3 | 22,3 | 22,5 |
| 128 | - | 28,4 | - | 26,6 | - | - | 25,7 | 25,9 | 24,0 | 24,3 | - | 23,4 | 23,7 | 21,6 | 21,9 |
| 129 | - | - | - | 26,0 | - | - | 25,0 | 25,3 | 23,3 | 23,6 | - | 22,7 | 23,0 | 21,0 | 21,2 |
| 130 | - | - | - | 25,4 | - | - | 24,4 | - | 22,7 | 23,0 | - | 22,1 | 22,4 | 20,4 | 20,6 |
| 131 | - | - | - | 24,9 | - | - | 23,8 | - | 22,1 | 22,4 | - | 21,5 | 21,8 | 19,8 | 20,0 |
| 132 | - | - | - | - | - | - | 23,2 | - | 21,5 | 21,8 | - | 20,9 | 21,2 | 19,2 | 19,4 |
| 133 | - | - | - | - | - | - | 22,7 | - | 20,9 | - | - | 20,3 | 20,6 | 18,6 | 18,9 |
| 134 | - | - | - | - | - | - | - | - | 20,4 | - | - | 19,8 | 20,0 | 18,0 | 18,3 |
| 136 | - | - | - | - | - | - | - | - | 19,3 | - | - | 18,7 | - | 16,9 | 17,2 |
| 137 | - | - | - | - | - | - | - | - | - | - | - | 18,1 | - | 16,3 | 16,6 |
| 138 | - | - | - | - | - | - | - | - | - | - | - | 17,6 | - | 15,8 | - |
| 139 | - | - | - | - | - | - | - | - | - | - | - | 17,1 | - | 15,3 | - |
| 141 | - | - | - | - | - | - | - | - | - | - | - | - | - | 14,3 | - |
| 142 | - | - | - | - | - | - | - | - | - | - | - | - | - | - | 12,8 |
| 144 | - | - | - | - | - | - | - | - | - | - | - | - | - | - | 11,8 |









| 225 t + 50 t | | 8,40 m | | 9.8 m/s | | 360° | | ISO | | | | | | | | | | |
|--------------|-------|---------|------|---------|------|---------|------|---------|------|---------|------|---------|------|------|------|------|------|-----|
| 147 m | | 150 m | | 153 m | | 156 m | | 159 m | | 162 m | | 165 m | | | | | | |
| LSL+LF_14 | | | | | | | | | | | | | | | | | | |
| 18 m | | | | | | | | | | | | | | | | | | |
| 0t-325t | | 0t | | 0t-325t | | 0t | | 0t-325t | | 0t | | 0t-325t | | | | | | |
| 15° 20° | | 15° 20° | | 15° 20° | | 15° 20° | | 15° 20° | | 15° 20° | | 15° 20° | | | | | | |
| m | t | t | t | t | t | t | t | t | t | t | t | t | t | m | | | | |
| 21 | 107,0 | - | 77,5 | 102,0 | - | 98,5 | - | - | - | - | - | - | - | 21 | | | | |
| 22 | 107,0 | - | 73,0 | 102,0 | - | 98,5 | - | 69,5 | 94,5 | - | 90,0 | - | 66,0 | 87,0 | - | 83,0 | - | 22 |
| 23 | 107,0 | 82,0 | 69,2 | 102,0 | 82,0 | 98,5 | 82,5 | 65,7 | 94,5 | 82,5 | 90,0 | - | 62,5 | 87,0 | - | 83,0 | - | 23 |
| 24 | 107,0 | 80,5 | 65,5 | 102,0 | 81,0 | 98,5 | 81,0 | 62,0 | 94,5 | 81,5 | 90,0 | 81,5 | 59,0 | 87,0 | 80,5 | 83,0 | 77,0 | 24 |
| 26 | 106,0 | 78,5 | 59,0 | 102,0 | 78,7 | 98,5 | 79,0 | 55,8 | 94,5 | 79,2 | 90,0 | 79,5 | 52,8 | 86,7 | 79,0 | 82,5 | 76,8 | 26 |
| 28 | 105,0 | 76,5 | 52,5 | 102,0 | 76,5 | 98,5 | 77,0 | 49,6 | 94,5 | 77,0 | 90,0 | 77,5 | 46,6 | 86,5 | 77,5 | 82,5 | 76,5 | 28 |
| 30 | 101,5 | 74,5 | 47,3 | 100,5 | 74,7 | 98,0 | 75,0 | 44,4 | 94,0 | 75,2 | 89,7 | 75,5 | 41,6 | 86,2 | 75,7 | 82,2 | 75,5 | 30 |
| 34 | 95,2 | 70,7 | 37,9 | 96,0 | 71,2 | 95,5 | 71,2 | 35,1 | 93,0 | 71,7 | 89,0 | 72,0 | 32,4 | 85,5 | 72,2 | 81,5 | 72,7 | 34 |
| 38 | 89,7 | 67,5 | 30,0 | 90,5 | 67,7 | 91,0 | 68,0 | 27,3 | 90,7 | 68,5 | 87,7 | 68,7 | 24,8 | 84,5 | 69,0 | 80,5 | 69,5 | 38 |
| 42 | 84,8 | 64,5 | 23,4 | 85,6 | 64,6 | 86,1 | 65,1 | 20,9 | 86,8 | 65,5 | 86,0 | 65,6 | 18,4 | 82,8 | 66,1 | 79,5 | 66,5 | 42 |
| 46 | 80,5 | 61,5 | 17,6 | 81,0 | 62,0 | 81,5 | 62,5 | 15,1 | 82,5 | 62,5 | 83,0 | 63,0 | 12,7 | 80,5 | 63,5 | 77,5 | 63,5 | 46 |
| 50 | 76,5 | 59,1 | 12,8 | 77,0 | 59,6 | 77,8 | 59,8 | 10,4 | 78,5 | 60,1 | 79,0 | 60,6 | 8,1 | 77,8 | 60,8 | 75,0 | 61,1 | 50 |
| 54 | 72,9 | 56,8 | 8,4 | 73,3 | 57,3 | 74,2 | 57,5 | 6,1 | 74,7 | 58,0 | 75,3 | 58,2 | 3,7 | 75,0 | 58,5 | 72,6 | 59,0 | 54 |
| 56 | 71,3 | 55,6 | 6,5 | 71,6 | 56,1 | 72,4 | 56,5 | 4,1 | 73,0 | 57,0 | 73,6 | 57,0 | - | 73,7 | 57,5 | 71,3 | 58,0 | 56 |
| 58 | 69,5 | 54,5 | 4,6 | 70,0 | 55,0 | 71,0 | 55,5 | - | 71,5 | 56,0 | 72,0 | 56,0 | - | 72,5 | 56,5 | 70,0 | 57,0 | 58 |
| 59 | 68,7 | 54,0 | 3,7 | 69,5 | 54,5 | 70,2 | 55,0 | - | 70,7 | 55,5 | 71,2 | 55,5 | - | 71,7 | 56,0 | 69,4 | 56,5 | 59 |
| 62 | 66,5 | 52,8 | - | 67,4 | 53,0 | 68,0 | 53,5 | - | 68,5 | 54,0 | 69,0 | 54,0 | - | 69,5 | 54,5 | 67,6 | 55,0 | 62 |
| 66 | 63,8 | 51,1 | - | 64,6 | 51,2 | 65,1 | 51,6 | - | 65,6 | 52,1 | 66,1 | 52,1 | - | 66,8 | 52,7 | 65,3 | 53,2 | 66 |
| 70 | 61,5 | 49,4 | - | 62,0 | 49,8 | 62,5 | 50,0 | - | 63,0 | 50,5 | 63,5 | 50,5 | - | 64,5 | 51,0 | 63,0 | 51,5 | 70 |
| 74 | 59,1 | 47,9 | - | 59,6 | 48,2 | 60,1 | 48,6 | - | 60,6 | 48,9 | 61,5 | 49,3 | - | 61,8 | 49,6 | 60,2 | 49,9 | 74 |
| 78 | 57,0 | 46,4 | - | 57,5 | 46,8 | 58,0 | 47,2 | - | 58,5 | 47,5 | 59,3 | 47,9 | - | 59,1 | 48,2 | 57,7 | 48,5 | 78 |
| 82 | 55,0 | 45,1 | - | 55,5 | 45,5 | 56,0 | 45,8 | - | 56,5 | 46,2 | 57,0 | 46,5 | - | 56,5 | 46,8 | 55,5 | 47,2 | 82 |
| 86 | 53,3 | 43,9 | - | 53,8 | 44,2 | 54,3 | 44,6 | - | 54,9 | 44,9 | 54,8 | 45,2 | - | 53,3 | 45,6 | 51,3 | 45,9 | 86 |
| 90 | 50,9 | 42,7 | - | 52,2 | 43,0 | 52,5 | 43,4 | - | 52,0 | 43,7 | 50,3 | 44,0 | - | 49,3 | 44,4 | 47,2 | 44,7 | 90 |
| 94 | 47,8 | 41,7 | - | 50,5 | 42,0 | 49,1 | 42,3 | - | 48,0 | 42,6 | 46,1 | 42,9 | - | 45,1 | 43,3 | 43,1 | 43,6 | 94 |
| 98 | 43,4 | 40,6 | - | 46,5 | 41,0 | 44,7 | 41,3 | - | 43,8 | 41,6 | 41,9 | 41,9 | - | 41,1 | 41,7 | 39,1 | 40,5 | 98 |
| 102 | 39,3 | 38,8 | - | 42,5 | 40,1 | 40,7 | 39,7 | - | 39,8 | 39,7 | 38,0 | 39,4 | - | 37,2 | 38,9 | 35,3 | 37,0 | 102 |
| 106 | 35,5 | 36,1 | - | 38,6 | 39,1 | 36,9 | 37,6 | - | 36,0 | 37,0 | 34,2 | 35,5 | - | 33,5 | 34,9 | 31,7 | 33,1 | 106 |
| 110 | 32,0 | 32,6 | - | 35,1 | 35,7 | 33,3 | 34,0 | - | 32,4 | 33,0 | 30,6 | 31,4 | - | 29,9 | 30,8 | 28,2 | 29,2 | 110 |
| 114 | 28,9 | 29,4 | - | 31,8 | 32,4 | 30,1 | 30,6 | - | 29,1 | 29,7 | 27,3 | 27,9 | - | 26,5 | 27,2 | 24,9 | 25,3 | 114 |
| 118 | 25,9 | 26,3 | - | 28,9 | 29,3 | 27,1 | 27,6 | - | 26,1 | 26,7 | 24,3 | 24,9 | - | 23,4 | 24,1 | 21,7 | 22,3 | 118 |
| 122 | 23,0 | 23,4 | - | 26,1 | 26,4 | 24,3 | 24,8 | - | 23,3 | 23,8 | 21,5 | 22,1 | - | 20,7 | 21,3 | 18,9 | 19,5 | 122 |
| 126 | 20,3 | 20,7 | - | 23,4 | 23,7 | 21,7 | 22,0 | - | 20,7 | 21,1 | 18,9 | 19,4 | - | 18,1 | 18,6 | 16,4 | 16,9 | 126 |
| 130 | 17,8 | 18,1 | - | 20,8 | 21,1 | 19,1 | 19,4 | - | 18,2 | 18,5 | 16,4 | 16,8 | - | 15,7 | 16,1 | 14,0 | 14,4 | 130 |
| 134 | 15,4 | 15,7 | - | 18,4 | 18,7 | 16,7 | 17,0 | - | 15,8 | 16,1 | 14,1 | 14,4 | - | 13,3 | 13,7 | 11,1 | 11,7 | 134 |
| 138 | 13,2 | 13,4 | - | 16,2 | 16,4 | 14,5 | 14,8 | - | 13,6 | 13,8 | 11,8 | 12,2 | - | 10,8 | 11,1 | 7,8 | 8,1 | 138 |
| 142 | 11,1 | 11,3 | - | 14,1 | 14,3 | 12,4 | 12,7 | - | 11,5 | 11,7 | 9,8 | 10,0 | - | 8,0 | 8,2 | 4,6 | 4,7 | 142 |
| 143 | 10,6 | - | - | 13,6 | 13,8 | 11,9 | 12,2 | - | 11,0 | 11,2 | 9,1 | 9,4 | - | 7,3 | 7,5 | 3,9 | 4,0 | 143 |
| 144 | 10,1 | - | - | 13,1 | 13,4 | 11,4 | 11,7 | - | 10,5 | 10,7 | 8,5 | 8,8 | - | 6,6 | 6,8 | - | - | 144 |
| 146 | 9,2 | - | - | 12,1 | - | 10,4 | 10,7 | - | 9,5 | 9,7 | 7,2 | 7,6 | - | 5,2 | 5,5 | - | - | 146 |
| 147 | - | - | - | 11,7 | - | 9,9 | 10,2 | - | 9,0 | 9,2 | 6,5 | 7,0 | - | 4,5 | 4,8 | - | - | 147 |
| 148 | - | - | - | 11,2 | - | 9,5 | - | - | 8,6 | 8,8 | 5,9 | 6,5 | - | 3,8 | 4,2 | - | - | 148 |
| 149 | - | - | - | 10,8 | - | 9,0 | - | - | 8,1 | 8,4 | 5,3 | 5,9 | - | - | 3,6 | - | - | 149 |
| 150 | - | - | - | - | - | 8,6 | - | - | 7,7 | - | 4,8 | 5,3 | - | - | - | - | - | 150 |
| 151 | - | - | - | - | - | 8,2 | - | - | 7,3 | - | 4,2 | 4,8 | - | - | - | - | - | 151 |
| 152 | - | - | - | - | - | 7,8 | - | - | 6,8 | - | 3,7 | - | - | - | - | - | - | 152 |
| 154 | - | - | - | - | - | - | - | - | 6,0 | - | - | - | - | - | - | - | - | 154 |

0t
65t
95t
125t
165t
205t
265t
325t

| 165 t + 50 t | | 8,40 m | | | | | | 9.8 m/s | | | | | | 360° | | | | | | ISO | | | | | | |
|--------------|------|--------|---------|------|------|------|------|---------|---------|------|------|------|------|------|---------|------|------|------|------|------|---------|------|------|------|------|-----|
| 72 m | | | | 78 m | | | | 84 m | | | | 90 m | | | | 96 m | | | | | | | | | | |
| LSL+LF_2 | | | | | | | | | | | | | | | | | | | | | | | | | | |
| 24 m | | | | | | | | | | | | | | | | | | | | | | | | | | |
| 0 t | | | 0t-325t | | | 0 t | | | 0t-325t | | | 0 t | | | 0t-325t | | | 0 t | | | 0t-325t | | | | | |
| 15° | | | 20° | | | 30° | | | 15° | | | 20° | | | 30° | | | 15° | | | 20° | | | 30° | | |
| m | t | t | t | t | t | t | t | t | t | t | t | t | t | t | t | t | t | t | t | t | t | t | t | t | m | |
| 16 | 86,5 | 86,5 | - | - | - | - | - | - | - | - | - | - | - | - | - | - | - | - | - | - | - | - | - | - | 16 | |
| 17 | 84,0 | 84,0 | - | - | 84,5 | 85,0 | - | - | 85,0 | 85,5 | - | - | - | - | - | - | - | - | - | - | - | - | - | - | 17 | |
| 18 | 81,5 | 81,5 | 63,5 | - | 82,0 | 83,0 | - | - | 83,0 | 83,5 | - | - | 83,5 | 84,0 | - | - | 83,5 | 84,0 | - | - | 83,5 | 84,0 | - | - | 18 | |
| 19 | 79,2 | 79,2 | 62,0 | - | 80,0 | 80,7 | 62,5 | - | 81,0 | 81,5 | 63,0 | - | 81,5 | 82,0 | - | - | 81,7 | 82,2 | - | - | 81,7 | 82,2 | - | - | 19 | |
| 20 | 77,0 | 77,0 | 60,5 | - | 78,0 | 78,5 | 61,0 | - | 79,0 | 79,5 | 62,0 | - | 79,5 | 80,0 | 62,5 | - | 80,0 | 80,5 | 62,5 | - | 80,0 | 80,5 | 62,5 | - | 20 | |
| 22 | 72,5 | 72,5 | 57,5 | 37,9 | 74,0 | 74,5 | 58,5 | 38,1 | 75,0 | 75,5 | 59,0 | - | 76,0 | 76,5 | 60,0 | - | 76,5 | 77,0 | 60,5 | - | 76,5 | 77,0 | 60,5 | - | 22 | |
| 23 | 70,7 | 70,7 | 56,2 | 37,3 | 72,2 | 72,5 | 57,2 | 37,5 | 73,5 | 73,7 | 57,7 | 37,6 | 74,5 | 75,0 | 58,7 | 37,7 | 75,0 | 75,5 | 59,2 | - | 75,0 | 75,5 | 59,2 | - | 23 | |
| 24 | 69,0 | 69,0 | 55,0 | 36,7 | 70,5 | 70,5 | 56,0 | 36,9 | 72,0 | 72,0 | 56,5 | 37,0 | 73,0 | 73,5 | 57,5 | 37,2 | 73,5 | 74,0 | 58,0 | 37,2 | 73,5 | 74,0 | 58,0 | 37,2 | 24 | |
| 26 | 65,5 | 65,5 | 52,5 | 35,6 | 67,0 | 67,0 | 53,5 | 35,8 | 69,0 | 69,0 | 54,5 | 36,0 | 70,0 | 70,0 | 55,5 | 36,2 | 70,5 | 71,0 | 56,0 | 36,2 | 70,5 | 71,0 | 56,0 | 36,2 | 26 | |
| 28 | 62,5 | 62,5 | 50,5 | 34,5 | 64,0 | 64,0 | 51,5 | 34,8 | 66,0 | 66,0 | 52,5 | 35,1 | 67,5 | 67,5 | 53,5 | 35,3 | 67,5 | 68,5 | 54,0 | 35,3 | 67,5 | 68,5 | 54,0 | 35,3 | 28 | |
| 30 | 59,5 | 59,5 | 48,8 | 33,5 | 61,5 | 61,5 | 49,8 | 33,9 | 63,0 | 63,0 | 50,5 | 34,1 | 64,0 | 64,5 | 51,5 | 34,4 | 62,0 | 66,0 | 52,5 | 34,5 | 62,0 | 66,0 | 52,5 | 34,5 | 30 | |
| 34 | 54,8 | 54,8 | 45,4 | 31,6 | 56,8 | 56,8 | 46,4 | 32,1 | 56,3 | 58,3 | 47,3 | 32,4 | 55,0 | 59,8 | 48,3 | 32,8 | 53,2 | 61,3 | 49,3 | 32,9 | 59,8 | 61,3 | 49,3 | 32,9 | 34 | |
| 38 | 50,1 | 50,7 | 42,3 | 29,9 | 51,0 | 52,6 | 43,4 | 30,4 | 49,6 | 54,1 | 44,4 | 30,8 | 47,1 | 55,6 | 45,4 | 31,2 | 45,6 | 57,0 | 46,3 | 31,5 | 45,6 | 57,0 | 46,3 | 31,5 | 38 | |
| 42 | 45,4 | 47,3 | 39,6 | 28,4 | 44,2 | 48,9 | 40,8 | 28,9 | 42,9 | 50,5 | 41,8 | 29,4 | 40,5 | 52,0 | 42,7 | 29,8 | 39,0 | 53,0 | 43,7 | 30,2 | 42,7 | 29,8 | 39,0 | 53,0 | 43,7 | 42 |
| 46 | 39,4 | 44,3 | 37,4 | 27,1 | 38,2 | 45,9 | 38,5 | 27,6 | 37,2 | 47,4 | 39,5 | 28,1 | 35,3 | 48,8 | 40,5 | 28,5 | 33,8 | 50,1 | 41,4 | 28,9 | 40,5 | 28,5 | 33,8 | 50,1 | 41,4 | 46 |
| 50 | 34,2 | 41,6 | 35,4 | 25,9 | 32,8 | 43,1 | 36,4 | 26,4 | 32,0 | 44,6 | 37,4 | 26,9 | 30,3 | 46,0 | 38,4 | 27,3 | 29,1 | 47,4 | 39,3 | 27,7 | 38,4 | 27,3 | 29,1 | 47,4 | 39,3 | 50 |
| 54 | 29,7 | 39,2 | 33,6 | 24,9 | 28,2 | 40,6 | 34,6 | 25,4 | 27,2 | 42,1 | 35,6 | 25,9 | 25,7 | 43,4 | 36,6 | 26,3 | 24,9 | 44,8 | 37,4 | 26,7 | 36,6 | 26,3 | 24,9 | 44,8 | 37,4 | 54 |
| 58 | 25,9 | 37,1 | 32,0 | 24,0 | 24,4 | 38,5 | 33,0 | 24,5 | 23,4 | 39,9 | 34,0 | 24,9 | 21,8 | 41,2 | 34,9 | 25,4 | 21,0 | 42,5 | 35,8 | 25,8 | 34,9 | 25,4 | 21,0 | 42,5 | 35,8 | 58 |
| 62 | 22,6 | 35,2 | 30,6 | 23,2 | 21,0 | 36,6 | 31,6 | 23,7 | 19,9 | 38,0 | 32,5 | 24,1 | 18,3 | 39,2 | 33,4 | 24,6 | 17,5 | 40,4 | 34,3 | 25,0 | 33,4 | 24,6 | 17,5 | 40,4 | 34,3 | 62 |
| 66 | 19,6 | 33,6 | 29,4 | 22,5 | 18,0 | 34,9 | 30,3 | 22,9 | 16,9 | 36,2 | 31,2 | 23,4 | 15,3 | 37,4 | 32,1 | 23,8 | 14,5 | 38,6 | 32,9 | 24,2 | 32,1 | 23,8 | 14,5 | 38,6 | 32,9 | 66 |
| 70 | 17,1 | 32,2 | 28,3 | 21,9 | 15,4 | 33,4 | 29,1 | 22,3 | 14,4 | 34,6 | 30,0 | 22,7 | 12,7 | 35,8 | 30,9 | 23,1 | 11,9 | 37,0 | 31,7 | 23,5 | 30,9 | 23,1 | 11,9 | 37,0 | 31,7 | 70 |
| 74 | 14,8 | 30,9 | 27,3 | 21,4 | 13,1 | 32,1 | 28,1 | 21,7 | 12,1 | 33,2 | 29,0 | 22,1 | 10,4 | 34,4 | 29,8 | 22,5 | 9,6 | 35,5 | 30,5 | 22,9 | 29,8 | 22,5 | 9,6 | 35,5 | 30,5 | 74 |
| 76 | 13,8 | 30,3 | 26,9 | 21,2 | 12,1 | 31,5 | 27,7 | 21,5 | 11,0 | 32,6 | 28,5 | 21,9 | 9,4 | 33,7 | 29,3 | 22,2 | 8,5 | 34,8 | 30,0 | 22,6 | 29,3 | 22,2 | 8,5 | 34,8 | 30,0 | 76 |
| 78 | 12,8 | 29,8 | 26,5 | - | 11,1 | 30,9 | 27,3 | 21,3 | 10,0 | 32,0 | 28,0 | 21,7 | 8,4 | 33,0 | 28,8 | 22,0 | 7,5 | 34,1 | 29,5 | 22,3 | 28,8 | 22,0 | 7,5 | 34,1 | 29,5 | 78 |
| 80 | 11,9 | 29,3 | 26,1 | - | 10,2 | 30,3 | 26,9 | 21,1 | 9,1 | 31,4 | 27,6 | 21,5 | 7,5 | 32,4 | 28,3 | 21,7 | 6,6 | 33,5 | 29,0 | 22,0 | 28,3 | 21,7 | 6,6 | 33,5 | 29,0 | 80 |
| 82 | 11,0 | 28,8 | 25,8 | - | 9,3 | 29,8 | 26,5 | - | 8,2 | 30,8 | 27,2 | 21,3 | 6,6 | 31,8 | 27,9 | 21,5 | 5,7 | 32,9 | 28,6 | 21,8 | 27,9 | 21,5 | 5,7 | 32,9 | 28,6 | 82 |
| 84 | 10,2 | 28,4 | 25,5 | - | 8,5 | 29,3 | 26,2 | - | 7,4 | 30,3 | 26,8 | 21,1 | 5,7 | 31,3 | 27,5 | 21,3 | 4,8 | 32,3 | 28,2 | 21,6 | 27,5 | 21,3 | 4,8 | 32,3 | 28,2 | 84 |
| 85 | 9,8 | 28,2 | - | - | 8,1 | 29,1 | 26,0 | - | 7,0 | 30,0 | 26,6 | 21,0 | 5,3 | 31,0 | 27,3 | 21,2 | 4,4 | 32,0 | 28,0 | 21,5 | 27,3 | 21,2 | 4,4 | 32,0 | 28,0 | 85 |
| 86 | 9,4 | 28,0 | - | - | 7,7 | 28,9 | 25,9 | - | 6,6 | 29,8 | 26,5 | - | 4,9 | 30,8 | 27,1 | 21,1 | 4,0 | 31,8 | 27,8 | 21,4 | 27,1 | 21,1 | 4,0 | 31,8 | 27,8 | 86 |
| 87 | 9,0 | 27,8 | - | - | 7,4 | 28,7 | 25,7 | - | 6,2 | 29,6 | 26,3 | - | 4,5 | 30,5 | 27,0 | 21,0 | 3,6 | 31,5 | 27,6 | 21,3 | 27,0 | 21,0 | 3,6 | 31,5 | 27,6 | 87 |
| 89 | - | - | - | - | 6,6 | 28,3 | 25,5 | - | 5,4 | 29,2 | 26,0 | - | 3,8 | 30,1 | 26,6 | 20,9 | - | 31,0 | 27,2 | 21,1 | 26,6 | 20,9 | - | 31,0 | 27,2 | 89 |
| 90 | - | - | - | - | 6,3 | 28,1 | - | - | 5,1 | 29,0 | 25,9 | - | - | 29,8 | 26,5 | - | - | 30,8 | 27,1 | 21,1 | 26,5 | - | - | 30,8 | 27,1 | 90 |
| 92 | - | - | - | - | 5,6 | 27,8 | - | - | 4,4 | 28,6 | 25,6 | - | - | 29,4 | 26,2 | - | - | 30,3 | 26,7 | 20,9 | 26,2 | - | - | 30,3 | 26,7 | 92 |
| 93 | - | - | - | - | - | - | - | - | 4,1 | 28,4 | 25,5 | - | - | 29,2 | 26,0 | - | - | 30,1 | 26,6 | 20,8 | 26,0 | - | - | 30,1 | 26,6 | 93 |
| 94 | - | - | - | - | - | - | - | - | 3,8 | 28,2 | 25,4 | - | - | 29,0 | 25,9 | - | - | 29,8 | 26,4 | - | 25,4 | - | - | 29,8 | 26,4 | 94 |
| 95 | - | - | - | - | - | - | - | - | 3,5 | 28,0 | - | - | - | 28,8 | 25,7 | - | - | 29,6 | 26,2 | - | 25,7 | - | - | 29,6 | 26,2 | 95 |
| 98 | - | - | - | - | - | - | - | - | - | 27,6 | - | - | - | 28,3 | 25,4 | - | - | 29,0 | 25,8 | - | 25,4 | - | - | 29,0 | 25,8 | 98 |
| 99 | - | - | - | - | - | - | - | - | - | - | - | - | - | 28,1 | 25,3 | - | - | 28,8 | 25,7 | - | 25,3 | - | - | 28,8 | 25,7 | 99 |
| 102 | - | - | - | - | - | - | - | - | - | - | - | - | - | 27,7 | - | - | - | 28,3 | 25,4 | - | 25,7 | - | - | 28,3 | 25,4 | 102 |
| 103 | - | - | - | - | - | - | - | - | - | - | - | - | - | 27,5 | - | - | - | 28,1 | 25,3 | - | 25,7 | - | - | 28,1 | 25,3 | 103 |
| 105 | - | - | - | - | - | - | - | - | - | - | - | - | - | - | - | - | - | 27,9 | 25,1 | - | 25,7 | - | - | 27,9 | 25,1 | 105 |
| 106 | - | - | - | - | - | - | - | - | - | - | - | - | - | - | - | - | - | 27,7 | - | - | 25,7 | - | - | 27,7 | - | 106 |
| 108 | - | - | - | - | - | - | - | - | - | - | - | - | - | - | - | - | - | 27,5 | - | - | 25,7 | - | - | 27,5 | - | 108 |

| | | | | | | | | |
|--|----|-----|-----|------|------|------|------|------|
| | 0t | 65t | 95t | 125t | 165t | 205t | 265t | 325t |
|--|----|-----|-----|------|------|------|------|------|

| 165 t + 50 t | | 8,40 m | | 9.8 m/s | | 360° | | ISO | | | | | | | | | | | |
|--------------|------|---------|------|----------|---|------|---|----------|------|------|------|----------|---|------|---|------|---|------|-----|
| 114 m | | | | 117 m | | | | 120 m | | | | 123 m | | | | | | | |
| LSL+LF_2 | | | | LSL+LF_4 | | | | LSL+LF_2 | | | | LSL+LF_4 | | | | | | | |
| 24 m | | | | | | | | | | | | | | | | | | | |
| 0 t | | 0t-325t | | | | | | | | 0 t | | 0t-325t | | | | | | | |
| 15° | | 20° | | 30° | | 15° | | 20° | | 15° | | 20° | | 30° | | 15° | | 20° | |
| m | t | t | t | t | t | t | t | t | t | t | t | t | t | t | t | t | t | t | m |
| 20 | 77,5 | 80,0 | - | - | - | - | - | - | - | - | - | - | - | - | - | - | - | - | 20 |
| 21 | 77,2 | 79,5 | - | - | - | - | - | - | 72,0 | 75,0 | - | - | - | - | - | - | - | - | 21 |
| 22 | 77,0 | 79,0 | 61,5 | - | - | 56,5 | - | 57,0 | 72,0 | 74,5 | 61,0 | - | - | - | - | - | - | - | 22 |
| 23 | 73,2 | 77,7 | 60,5 | - | - | 55,7 | - | 56,0 | 69,5 | 74,0 | 60,0 | - | - | 56,0 | - | 56,0 | - | 56,0 | 23 |
| 24 | 71,0 | 76,5 | 59,5 | - | - | 55,0 | - | 55,0 | 68,5 | 73,5 | 59,0 | - | - | 55,5 | - | 55,5 | - | 55,5 | 24 |
| 26 | 64,5 | 74,0 | 57,5 | 36,6 | - | 53,0 | - | 53,5 | 62,0 | 72,0 | 57,5 | 36,5 | - | 53,5 | - | 54,0 | - | 54,0 | 26 |
| 28 | 58,5 | 71,5 | 56,0 | 35,8 | - | 51,5 | - | 52,0 | 56,5 | 71,0 | 56,0 | 35,7 | - | 52,0 | - | 52,5 | - | 52,5 | 28 |
| 30 | 53,5 | 69,0 | 54,5 | 35,0 | - | 50,0 | - | 50,5 | 51,5 | 69,0 | 55,0 | 35,0 | - | 51,0 | - | 51,0 | - | 51,0 | 30 |
| 34 | 45,3 | 64,6 | 51,5 | 33,6 | - | 47,6 | - | 48,1 | 43,4 | 65,3 | 52,0 | 33,7 | - | 48,4 | - | 48,7 | - | 48,7 | 34 |
| 38 | 38,0 | 60,6 | 48,7 | 32,3 | - | 45,3 | - | 45,7 | 36,3 | 61,6 | 49,2 | 32,5 | - | 46,1 | - | 46,5 | - | 46,5 | 38 |
| 42 | 31,7 | 57,0 | 46,1 | 31,1 | - | 43,1 | - | 43,5 | 30,1 | 58,0 | 46,8 | 31,4 | - | 43,9 | - | 44,3 | - | 44,3 | 42 |
| 46 | 26,8 | 53,6 | 43,8 | 29,9 | - | 41,2 | - | 41,6 | 25,3 | 55,0 | 44,5 | 30,2 | - | 41,9 | - | 42,4 | - | 42,4 | 46 |
| 50 | 22,4 | 50,8 | 41,7 | 28,8 | - | 39,4 | - | 39,8 | 20,9 | 52,1 | 42,4 | 29,1 | - | 40,1 | - | 40,6 | - | 40,6 | 50 |
| 54 | 18,4 | 48,4 | 39,9 | 27,8 | - | 37,8 | - | 38,2 | 17,0 | 49,5 | 40,6 | 28,1 | - | 38,5 | - | 39,0 | - | 39,0 | 54 |
| 58 | 15,2 | 46,0 | 38,2 | 26,8 | - | 36,2 | - | 36,6 | 13,8 | 47,1 | 38,9 | 27,1 | - | 37,0 | - | 37,4 | - | 37,4 | 58 |
| 62 | 12,2 | 43,9 | 36,6 | 26,0 | - | 34,8 | - | 35,2 | 10,8 | 45,0 | 37,3 | 26,3 | - | 35,6 | - | 36,0 | - | 36,0 | 62 |
| 66 | 9,4 | 42,0 | 35,2 | 25,2 | - | 33,4 | - | 33,9 | 8,2 | 43,0 | 35,9 | 25,6 | - | 34,2 | - | 34,7 | - | 34,7 | 66 |
| 70 | 6,8 | 40,2 | 33,9 | 24,5 | - | 32,2 | - | 32,6 | 5,7 | 41,2 | 34,6 | 24,8 | - | 33,0 | - | 33,5 | - | 33,5 | 70 |
| 73 | 4,9 | 39,0 | 33,0 | 24,0 | - | 31,3 | - | 31,7 | 4,0 | 40,0 | 33,7 | 24,3 | - | 32,1 | - | 32,6 | - | 32,6 | 73 |
| 74 | 4,3 | 38,6 | 32,8 | 23,9 | - | 31,0 | - | 31,4 | - | 39,6 | 33,4 | 24,2 | - | 31,8 | - | 32,3 | - | 32,3 | 74 |
| 75 | 3,8 | 38,2 | 32,5 | 23,7 | - | 30,8 | - | 31,2 | - | 39,2 | 33,1 | 24,0 | - | 31,6 | - | 32,0 | - | 32,0 | 75 |
| 78 | - | 37,1 | 31,7 | 23,3 | - | 30,0 | - | 30,4 | - | 38,1 | 32,3 | 23,6 | - | 30,8 | - | 31,2 | - | 31,2 | 78 |
| 82 | - | 35,8 | 30,7 | 22,7 | - | 29,1 | - | 29,5 | - | 36,7 | 31,3 | 23,0 | - | 29,8 | - | 30,2 | - | 30,2 | 82 |
| 86 | - | 34,6 | 29,7 | 22,2 | - | 28,3 | - | 28,7 | - | 35,5 | 30,3 | 22,5 | - | 29,0 | - | 29,4 | - | 29,4 | 86 |
| 90 | - | 33,4 | 28,9 | 21,8 | - | 27,6 | - | 28,0 | - | 34,3 | 29,5 | 22,1 | - | 28,3 | - | 28,6 | - | 28,6 | 90 |
| 94 | - | 32,4 | 28,2 | 21,4 | - | 26,8 | - | 27,2 | - | 33,2 | 28,7 | 21,7 | - | 27,5 | - | 27,9 | - | 27,9 | 94 |
| 98 | - | 31,4 | 27,5 | 21,0 | - | 26,2 | - | 26,5 | - | 32,2 | 28,0 | 21,3 | - | 26,9 | - | 27,1 | - | 27,1 | 98 |
| 102 | - | 30,6 | 26,9 | 20,8 | - | 25,6 | - | 25,9 | - | 31,4 | 27,4 | 21,0 | - | 26,2 | - | 26,5 | - | 26,5 | 102 |
| 106 | - | 29,8 | 26,3 | 20,5 | - | 25,0 | - | 25,3 | - | 30,6 | 26,8 | 20,7 | - | 25,6 | - | 25,9 | - | 25,9 | 106 |
| 107 | - | 29,6 | 26,1 | 20,5 | - | 24,9 | - | 25,2 | - | 30,4 | 26,6 | 20,6 | - | 25,5 | - | 25,8 | - | 25,8 | 107 |
| 110 | - | 29,1 | 25,8 | - | - | 24,5 | - | 24,8 | - | 29,8 | 26,2 | 20,5 | - | 25,1 | - | 25,3 | - | 25,3 | 110 |
| 111 | - | 28,9 | 25,7 | - | - | 24,4 | - | 24,7 | - | 29,6 | 26,1 | 20,4 | - | 25,0 | - | 25,2 | - | 25,2 | 111 |
| 114 | - | 28,5 | 25,4 | - | - | 24,1 | - | 24,4 | - | 29,1 | 25,8 | - | - | 24,6 | - | 24,9 | - | 24,9 | 114 |
| 118 | - | 27,9 | 25,0 | - | - | 23,7 | - | 24,0 | - | 28,5 | 25,4 | - | - | 24,2 | - | 24,4 | - | 24,4 | 118 |
| 120 | - | 27,7 | 24,9 | - | - | 22,0 | - | 23,8 | - | 28,2 | 25,2 | - | - | 24,0 | - | 24,2 | - | 24,2 | 120 |
| 122 | - | 27,4 | - | - | - | - | - | 23,6 | - | 27,9 | 25,0 | - | - | 23,8 | - | 24,0 | - | 24,0 | 122 |
| 123 | - | 27,3 | - | - | - | - | - | 6,3 | - | 27,8 | 24,9 | - | - | 23,7 | - | 23,9 | - | 23,9 | 123 |
| 124 | - | 27,2 | - | - | - | - | - | - | - | 27,7 | 24,9 | - | - | 23,7 | - | 23,8 | - | 23,8 | 124 |
| 125 | - | - | - | - | - | - | - | - | - | 27,6 | 24,8 | - | - | 23,6 | - | 23,8 | - | 23,8 | 125 |
| 126 | - | - | - | - | - | - | - | - | - | 27,5 | - | - | - | - | - | 23,7 | - | 23,7 | 126 |
| 128 | - | - | - | - | - | - | - | - | - | 27,3 | - | - | - | - | - | 8,4 | - | 8,4 | 128 |
| 129 | - | - | - | - | - | - | - | - | - | 27,2 | - | - | - | - | - | - | - | - | 129 |



| 165 t + 50 t | | 8,40 m | | 9.8 m/s | | 360° | | ISO | | |
|--------------|------|-------------|------|-----------|---|----------|------|-----------|------|-----|
| 126 m | | 129 m | | 24 m | | | | | | |
| LSL+LF_2 | | LSL+LF_4 | | LSL+LF_14 | | LSL+LF_4 | | LSL+LF_14 | | |
| 0 t | | 0 t - 325 t | | | | | | | | |
| 15° | | 20° | | 30° | | 15° | | 20° | | |
| 15° | | 20° | | 15° | | 20° | | 15° | | |
| m | t | t | t | t | t | t | t | t | t | m |
| 21 | 65,5 | 68,5 | - | - | - | 88,0 | - | - | 89,0 | 21 |
| 22 | 65,5 | 68,0 | - | - | - | 86,0 | - | - | 87,0 | 22 |
| 23 | 64,5 | 68,0 | 58,5 | - | - | 84,5 | 61,5 | - | 85,2 | 23 |
| 24 | 64,0 | 68,0 | 58,0 | - | - | 83,0 | 60,5 | - | 83,5 | 24 |
| 26 | 60,0 | 67,5 | 57,0 | - | - | 80,0 | 58,5 | - | 80,5 | 26 |
| 27 | 57,2 | 67,5 | 56,5 | 36,0 | - | 78,5 | 57,5 | - | 79,0 | 27 |
| 28 | 54,5 | 67,5 | 56,0 | 35,7 | - | 77,0 | 56,5 | - | 77,5 | 28 |
| 30 | 50,0 | 67,0 | 54,5 | 35,0 | - | 74,2 | 55,0 | - | 74,7 | 30 |
| 34 | 42,0 | 64,0 | 52,1 | 33,7 | - | 69,2 | 52,0 | - | 69,7 | 34 |
| 38 | 34,9 | 61,0 | 49,8 | 32,5 | - | 65,0 | 49,3 | - | 65,5 | 38 |
| 42 | 28,9 | 58,0 | 47,4 | 31,4 | - | 61,1 | 47,0 | - | 61,6 | 42 |
| 46 | 24,1 | 55,3 | 45,2 | 30,3 | - | 47,3 | 57,5 | - | 47,6 | 46 |
| 50 | 19,7 | 52,6 | 43,1 | 29,3 | - | 45,4 | 54,5 | - | 45,7 | 50 |
| 54 | 15,9 | 50,0 | 41,3 | 28,3 | - | 43,6 | 51,8 | - | 43,9 | 54 |
| 58 | 12,7 | 47,9 | 39,6 | 27,4 | - | 41,9 | 49,4 | - | 42,2 | 58 |
| 62 | 9,8 | 45,9 | 38,0 | 26,6 | - | 40,3 | 47,2 | - | 40,6 | 62 |
| 66 | 7,2 | 43,9 | 36,6 | 25,8 | - | 38,8 | 45,1 | - | 39,2 | 66 |
| 70 | 4,9 | 42,0 | 35,3 | 25,1 | - | 37,5 | 43,2 | - | 37,9 | 70 |
| 72 | 3,8 | 41,2 | 34,7 | 24,8 | - | 36,9 | 42,3 | - | 37,3 | 72 |
| 74 | - | 40,4 | 34,1 | 24,5 | - | 36,3 | 41,5 | - | 36,7 | 74 |
| 78 | - | 39,0 | 33,0 | 23,9 | - | 35,2 | 39,9 | - | 35,6 | 78 |
| 82 | - | 37,6 | 32,0 | 23,3 | - | 34,2 | 38,5 | - | 34,5 | 82 |
| 86 | - | 36,4 | 31,0 | 22,7 | - | 33,2 | 37,1 | - | 33,5 | 86 |
| 90 | - | 35,2 | 30,1 | 22,3 | - | 32,3 | 35,9 | - | 32,6 | 90 |
| 94 | - | 34,1 | 29,3 | 21,9 | - | 31,4 | 34,8 | - | 31,7 | 94 |
| 98 | - | 33,1 | 28,5 | 21,5 | - | 30,6 | 33,7 | - | 30,9 | 98 |
| 102 | - | 32,1 | 27,9 | 21,2 | - | 29,9 | 32,8 | - | 30,2 | 102 |
| 106 | - | 31,3 | 27,3 | 20,8 | - | 29,3 | 31,9 | - | 29,5 | 106 |
| 110 | - | 30,5 | 26,7 | 20,6 | - | 28,7 | 31,1 | - | 28,9 | 110 |
| 114 | - | 29,8 | 26,2 | 20,4 | - | 28,1 | 30,3 | - | 28,3 | 114 |
| 116 | - | 29,4 | 25,9 | 20,3 | - | 27,9 | 29,9 | - | 28,1 | 116 |
| 118 | - | 29,1 | 25,7 | - | - | 27,6 | 29,6 | - | 27,8 | 118 |
| 122 | - | 28,5 | 25,3 | - | - | 27,2 | 29,0 | - | 27,4 | 122 |
| 126 | - | 28,0 | 25,0 | - | - | 26,8 | 28,5 | - | 27,0 | 126 |
| 130 | - | 27,5 | 24,7 | - | - | 26,5 | 28,0 | - | 26,6 | 130 |
| 133 | - | 27,2 | - | - | - | 26,9 | - | - | 24,0 | 133 |
| 134 | - | 27,1 | - | - | - | 26,3 | - | - | 24,4 | 134 |
| 137 | - | - | - | - | - | - | - | - | 22,7 | 137 |

0 t 65 t 95 t 125 t 165 t 205 t 265 t 325 t

LSL+LF_14: 225 t + 50 t

| 165 t + 50 t | | 8,40 m | | 9.8 m/s | | 360° | | ISO | |
|--------------|------|-------------|------|-----------|---|----------|------|-----------|-----|
| 132 m | | 135 m | | 24 m | | | | | |
| LSL+LF_2 | | LSL+LF_4 | | LSL+LF_14 | | LSL+LF_4 | | LSL+LF_14 | |
| 0 t | | 0 t - 325 t | | | | | | | |
| 15° | | 20° | | 30° | | 15° | | 20° | |
| m | t | t | t | t | t | t | t | t | m |
| 22 | 59,5 | 61,5 | - | - | - | - | 87,5 | - | 22 |
| 24 | 59,5 | 61,0 | 54,5 | - | - | 61,5 | 84,0 | 60,5 | 24 |
| 26 | 57,0 | 60,5 | 54,5 | - | - | 60,0 | 81,0 | 58,7 | 26 |
| 27 | 54,5 | 60,5 | 54,2 | 35,9 | - | 59,2 | 79,5 | 57,8 | 27 |
| 28 | 52,5 | 60,5 | 54,0 | 35,6 | - | 58,5 | 78,0 | 57,0 | 28 |
| 30 | 48,0 | 60,0 | 53,5 | 35,0 | - | 57,0 | 75,5 | 55,5 | 30 |
| 34 | 40,1 | 59,0 | 51,8 | 33,8 | - | 54,3 | 70,5 | 52,5 | 34 |
| 38 | 33,2 | 57,8 | 49,9 | 32,7 | - | 51,9 | 66,0 | 49,9 | 38 |
| 42 | 27,2 | 56,5 | 47,7 | 31,5 | - | 49,8 | 62,1 | 47,6 | 42 |
| 46 | 22,5 | 54,8 | 45,6 | 30,4 | - | 47,7 | 58,5 | 45,4 | 46 |
| 50 | 18,3 | 53,0 | 43,6 | 29,4 | - | 45,8 | 55,5 | 43,4 | 50 |
| 54 | 14,5 | 51,0 | 41,8 | 28,5 | - | 44,1 | 52,8 | 41,6 | 54 |
| 58 | 11,3 | 49,0 | 40,2 | 27,6 | - | 42,4 | 50,5 | 39,9 | 58 |
| 62 | 8,4 | 47,0 | 38,6 | 26,8 | - | 40,8 | 48,2 | 38,3 | 62 |
| 66 | 5,8 | 45,0 | 37,2 | 26,1 | - | 39,4 | 46,1 | 36,9 | 66 |
| 70 | 3,5 | 42,8 | 35,9 | 25,4 | - | 38,1 | 44,2 | 35,7 | 70 |
| 74 | - | 41,0 | 34,7 | 24,7 | - | 36,9 | 42,5 | 34,5 | 74 |
| 78 | - | 39,5 | 33,6 | 24,1 | - | 35,8 | 40,9 | 33,3 | 78 |
| 82 | - | 38,2 | 32,6 | 23,5 | - | 34,8 | 39,4 | 32,3 | 82 |
| 86 | - | 37,0 | 31,6 | 23,0 | - | 33,8 | 38,0 | 31,4 | 86 |
| 90 | - | 35,9 | 30,7 | 22,6 | - | 32,9 | 36,8 | 30,5 | 90 |
| 94 | - | 34,8 | 29,9 | 22,1 | - | 32,0 | 35,6 | 29,7 | 94 |
| 98 | - | 33,8 | 29,1 | 21,7 | - | 31,2 | 34,5 | 28,9 | 98 |
| 102 | - | 32,9 | 28,4 | 21,4 | - | 30,5 | 33,5 | 28,3 | 102 |
| 106 | - | 32,0 | 27,8 | 21,0 | - | 29,8 | 32,6 | 27,6 | 106 |
| 110 | - | 31,2 | 27,2 | 20,7 | - | 29,2 | 31,8 | 27,1 | 110 |
| 114 | - | 30,4 | 26,6 | 20,5 | - | 28,6 | 31,0 | 26,5 | 114 |
| 118 | - | 29,7 | 26,1 | 20,3 | - | 28,0 | 30,3 | 26,1 | 118 |
| 120 | - | 29,4 | 25,9 | 20,2 | - | 27,8 | 29,9 | 25,9 | 120 |
| 122 | - | 29,1 | 25,7 | - | - | 27,6 | 29,6 | 25,7 | 122 |
| 126 | - | 28,5 | 25,3 | - | - | 27,2 | 28,5 | 25,3 | 126 |
| 130 | - | 28,0 | 24,9 | - | - | 26,8 | 25,9 | 25,0 | 130 |
| 134 | - | 27,6 | 24,6 | - | - | 26,5 | 23,5 | 23,6 | 134 |
| 135 | - | 27,5 | 24,6 | - | - | 26,5 | 22,9 | 23,3 | 135 |
| 136 | - | 27,4 | 12,6 | - | - | - | 22,3 | - | 136 |
| 138 | - | 27,2 | - | - | - | - | 21,2 | - | 138 |
| 139 | - | 27,1 | - | - | - | - | 20,7 | - | 139 |
| 142 | - | - | - | - | - | - | - | - | 142 |

0 t 65 t 95 t 125 t 165 t 205 t 265 t 325 t

LSL+LF_14: 225 t + 50 t



| 165 t + 50 t | | 8,40 m | | 9.8 m/s | | 360° | | ISO | | |
|--------------|------|-------------|------|-----------|---|----------|------|-----------|------|-----|
| 138 m | | 141 m | | 24 m | | | | | | |
| LSL+LF_2 | | LSL+LF_4 | | LSL+LF_14 | | LSL+LF_4 | | LSL+LF_14 | | |
| 0 t | | 0 t - 325 t | | | | | | | | |
| 15° | | 20° | | 30° | | 15° | | 20° | | |
| 15° | | 20° | | 15° | | 20° | | 15° | | |
| m | t | t | t | t | t | t | t | t | t | m |
| 22 | 52,0 | 54,0 | - | - | - | 87,5 | - | - | 89,0 | 22 |
| 24 | 52,0 | 53,5 | 48,9 | - | - | 59,5 | 84,5 | 61,0 | 58,0 | 24 |
| 25 | 52,0 | 53,2 | 48,8 | - | - | 59,0 | 83,1 | 60,0 | 57,7 | 25 |
| 26 | 52,0 | 53,0 | 48,8 | - | - | 59,0 | 81,7 | 59,1 | 57,5 | 26 |
| 28 | 50,0 | 52,5 | 48,6 | 35,4 | - | 58,0 | 79,0 | 57,5 | 57,5 | 28 |
| 30 | 46,4 | 52,5 | 48,3 | 34,8 | - | 57,0 | 76,5 | 56,0 | 57,0 | 30 |
| 34 | 38,7 | 51,5 | 47,5 | 33,6 | - | 54,6 | 71,5 | 53,0 | 54,6 | 34 |
| 38 | 31,9 | 50,6 | 46,6 | 32,4 | - | 52,3 | 67,0 | 50,4 | 52,5 | 38 |
| 42 | 26,0 | 50,0 | 45,6 | 31,3 | - | 50,0 | 63,1 | 48,2 | 50,5 | 42 |
| 46 | 21,4 | 49,0 | 44,5 | 30,3 | - | 48,1 | 59,5 | 46,0 | 48,6 | 46 |
| 50 | 17,2 | 47,9 | 43,3 | 29,3 | - | 46,3 | 56,5 | 44,0 | 46,8 | 50 |
| 54 | 13,5 | 46,5 | 41,9 | 28,4 | - | 44,6 | 53,8 | 42,2 | 45,0 | 54 |
| 58 | 10,4 | 45,1 | 40,5 | 27,5 | - | 43,0 | 51,5 | 40,5 | 43,4 | 58 |
| 62 | 7,6 | 43,7 | 39,0 | 26,7 | - | 41,5 | 49,2 | 39,0 | 41,9 | 62 |
| 66 | 5,0 | 42,3 | 37,6 | 26,1 | - | 40,1 | 47,1 | 37,5 | 40,5 | 66 |
| 68 | 3,8 | 41,6 | 36,9 | 25,7 | - | 39,3 | 46,1 | 36,9 | 39,8 | 68 |
| 70 | - | 40,9 | 36,2 | 25,4 | - | 38,7 | 45,2 | 36,3 | 39,1 | 70 |
| 74 | - | 39,6 | 34,9 | 24,8 | - | 37,5 | 43,4 | 35,1 | 37,9 | 74 |
| 78 | - | 38,2 | 33,8 | 24,3 | - | 36,3 | 41,8 | 33,9 | 36,7 | 78 |
| 82 | - | 36,8 | 32,8 | 23,7 | - | 35,3 | 40,3 | 32,9 | 35,6 | 82 |
| 86 | - | 35,6 | 32,0 | 23,2 | - | 34,3 | 38,9 | 31,9 | 34,6 | 86 |
| 90 | - | 34,4 | 31,2 | 22,8 | - | 33,4 | 37,6 | 31,0 | 33,8 | 90 |
| 94 | - | 33,2 | 30,4 | 22,3 | - | 32,6 | 36,4 | 30,2 | 32,9 | 94 |
| 98 | - | 31,7 | 29,6 | 21,9 | - | 31,8 | 35,3 | 29,4 | 32,1 | 98 |
| 102 | - | 30,8 | 28,9 | 21,6 | - | 31,0 | 34,3 | 28,7 | 31,3 | 102 |
| 106 | - | 30,0 | 28,2 | 21,2 | - | 30,3 | 33,4 | 28,1 | 30,5 | 106 |
| 110 | - | 29,2 | 27,6 | 20,9 | - | 29,7 | 32,5 | 27,5 | 29,9 | 110 |
| 114 | - | 28,7 | 27,1 | 20,6 | - | 29,1 | 31,7 | 26,9 | 29,3 | 114 |
| 118 | - | 28,3 | 26,5 | 20,4 | - | 28,5 | 30,9 | 26,5 | 28,7 | 118 |
| 122 | - | 28,0 | 26,0 | 20,2 | - | 27,9 | 28,8 | 26,0 | 28,2 | 122 |
| 125 | - | 27,9 | 25,7 | 20,1 | - | 27,6 | 26,9 | 25,5 | 27,8 | 125 |
| 126 | - | 27,8 | 25,6 | - | - | 27,5 | 26,3 | 25,2 | 27,7 | 126 |
| 130 | - | 27,6 | 25,2 | - | - | 26,6 | 23,7 | 24,0 | 25,8 | 130 |
| 134 | - | 27,3 | 24,9 | - | - | 25,0 | 21,2 | 21,6 | 23,6 | 134 |
| 138 | - | 26,9 | 24,7 | - | - | 22,9 | 19,0 | 19,3 | 21,5 | 138 |
| 140 | - | 26,0 | 24,6 | - | - | 21,9 | 17,9 | 18,2 | 20,5 | 140 |
| 141 | - | 25,6 | 14,1 | - | - | - | 17,4 | - | 20,0 | 141 |
| 142 | - | 25,1 | - | - | - | - | 16,9 | - | 19,5 | 142 |
| 143 | - | 24,7 | - | - | - | - | 16,4 | - | 19,1 | 143 |
| 144 | - | 24,3 | - | - | - | - | 15,9 | - | - | 144 |
| 146 | - | - | - | - | - | - | - | - | - | 146 |
| 147 | - | - | - | - | - | - | - | - | - | 147 |

0 t 65 t 95 t 125 t 165 t 205 t 265 t 325 t

LSL+LF_14: 225 t + 50 t

| 165 t + 50 t | | 8,40 m | | 9.8 m/s | | 360° | | ISO | | |
|--------------|------|-------------|------|-----------|---|----------|------|-----------|------|-----|
| 144 m | | 147 m | | 24 m | | | | | | |
| LSL+LF_2 | | LSL+LF_4 | | LSL+LF_14 | | LSL+LF_4 | | LSL+LF_14 | | |
| 0 t | | 0 t - 325 t | | | | | | | | |
| 15° | | 20° | | 30° | | 15° | | 20° | | |
| 15° | | 20° | | 15° | | 20° | | 15° | | |
| m | t | t | t | t | t | t | t | t | m | |
| 23 | 45,8 | 47,4 | - | - | - | 87,5 | - | - | 87,0 | 23 |
| 24 | 45,7 | 47,2 | - | - | - | 86,0 | - | - | 86,5 | 24 |
| 25 | 45,6 | 47,0 | 43,4 | - | - | 84,5 | 60,5 | - | 85,0 | 25 |
| 26 | 45,5 | 46,8 | 43,3 | - | - | 83,0 | 59,5 | - | 83,5 | 26 |
| 28 | 45,1 | 46,4 | 43,1 | 34,8 | - | 80,0 | 58,0 | - | 80,5 | 28 |
| 30 | 44,1 | 46,0 | 42,8 | 34,3 | - | 77,2 | 56,5 | - | 77,7 | 30 |
| 34 | 36,7 | 45,2 | 42,2 | 33,1 | - | 72,2 | 53,5 | - | 72,7 | 34 |
| 38 | 30,2 | 44,4 | 41,6 | 32,0 | - | 68,0 | 50,9 | - | 68,5 | 38 |
| 42 | 24,4 | 43,6 | 41,0 | 31,0 | - | 64,3 | 48,7 | - | 64,6 | 42 |
| 46 | 19,8 | 42,8 | 40,3 | 30,0 | - | 61,0 | 46,5 | - | 61,0 | 46 |
| 50 | 15,7 | 41,9 | 39,5 | 29,0 | - | 57,6 | 44,5 | - | 58,0 | 50 |
| 54 | 12,0 | 40,9 | 38,6 | 28,2 | - | 54,6 | 42,7 | - | 55,3 | 54 |
| 58 | 8,9 | 39,8 | 37,5 | 27,4 | - | 52,5 | 41,1 | - | 53,0 | 58 |
| 62 | 6,1 | 38,8 | 36,5 | 26,6 | - | 50,0 | 39,5 | - | 50,5 | 62 |
| 66 | 3,6 | 37,8 | 35,5 | 25,9 | - | 48,1 | 38,1 | - | 48,6 | 66 |
| 70 | - | 36,8 | 34,4 | 25,3 | - | 46,1 | 36,8 | - | 46,6 | 70 |
| 74 | - | 35,7 | 33,4 | 24,7 | - | 44,3 | 35,6 | - | 44,8 | 74 |
| 78 | - | 34,7 | 32,4 | 24,1 | - | 42,7 | 34,5 | - | 43,1 | 78 |
| 82 | - | 33,5 | 31,4 | 23,6 | - | 41,2 | 33,4 | - | 41,6 | 82 |
| 86 | - | 32,4 | 30,3 | 23,1 | - | 39,8 | 32,5 | - | 40,2 | 86 |
| 90 | - | 31,4 | 29,5 | 22,7 | - | 38,4 | 31,6 | - | 38,8 | 90 |
| 94 | - | 30,4 | 28,7 | 22,3 | - | 37,2 | 30,7 | - | 37,6 | 94 |
| 98 | - | 29,3 | 27,9 | 21,9 | - | 36,1 | 29,9 | - | 36,5 | 98 |
| 102 | - | 28,1 | 27,2 | 21,6 | - | 35,1 | 29,2 | - | 35,5 | 102 |
| 106 | - | 27,4 | 26,1 | 21,3 | - | 34,1 | 28,6 | - | 34,5 | 106 |
| 110 | - | 26,4 | 25,5 | 21,0 | - | 33,2 | 28,0 | - | 32,9 | 110 |
| 114 | - | 25,9 | 25,1 | 20,8 | - | 32,1 | 27,4 | - | 30,5 | 114 |
| 118 | - | 25,4 | 24,5 | 20,5 | - | 28,9 | 26,9 | - | 29,2 | 118 |
| 122 | - | 25,1 | 24,3 | 20,3 | - | 28,2 | 26,2 | - | 28,0 | 122 |
| 126 | - | 24,8 | 24,1 | 20,1 | - | 27,2 | 25,8 | - | 25,8 | 126 |
| 130 | - | 24,6 | 23,9 | 17,7 | - | 24,7 | 23,4 | - | 23,4 | 130 |
| 134 | - | 24,4 | 23,9 | - | - | 22,5 | 21,4 | - | 21,2 | 134 |
| 138 | - | 24,3 | 23,9 | - | - | 20,4 | 19,0 | - | 19,0 | 138 |
| 142 | - | 23,5 | 23,6 | - | - | 18,4 | 16,7 | - | 17,0 | 142 |
| 145 | - | 22,6 | 22,9 | - | - | 17,0 | 14,5 | - | 15,6 | 145 |
| 146 | - | 22,2 | 18,7 | - | - | - | 13,0 | - | 15,2 | 146 |
| 148 | - | 21,4 | - | - | - | - | - | - | 10,4 | 148 |
| 150 | - | 20,6 | - | - | - | - | - | - | 9,5 | 150 |
| 152 | - | - | - | - | - | - | - | - | 8,6 | 152 |

0 t
65 t
95 t
125 t
165 t
205 t
265 t
325 t

LSL+LF_14:  225 t +  50 t

| 165 t + 50 t | | 8,40 m | | 9.8 m/s | | 360° | | ISO | | | |
|--------------|------|-------------|------|----------|---|-----------|------|-------------|------|-----------|-----|
| 150 m | | 153 m | | 156 m | | 159 m | | 162 m | | 165 m | |
| LSL+LF_4 | | LSL+LF_14 | | LSL+LF_4 | | LSL+LF_14 | | LSL+LF_4 | | LSL+LF_14 | |
| 24 m | | | | | | | | | | | |
| 0 t | | 0 t - 325 t | | | | 0 t | | 0 t - 325 t | | | |
| 20° | | 15° | | 20° | | 15° | | 20° | | 15° | |
| m | t | t | t | t | t | t | t | t | t | t | m |
| 23 | - | - | 85,5 | - | - | - | 82,5 | - | - | - | 23 |
| 24 | - | - | 85,5 | - | - | - | 82,5 | - | - | - | 24 |
| 25 | 45,2 | 46,9 | 84,3 | - | - | 45,5 | 82,0 | - | - | - | 25 |
| 26 | 45,2 | 46,8 | 83,2 | 60,0 | - | 45,4 | 81,5 | 60,0 | 42,1 | 43,5 | 26 |
| 27 | 44,4 | 46,7 | 82,1 | 59,2 | - | 45,3 | 81,0 | 59,5 | 41,5 | 43,4 | 27 |
| 28 | 44,4 | 46,7 | 81,0 | 58,5 | - | 45,2 | 80,5 | 58,5 | 41,5 | 43,3 | 28 |
| 30 | 42,1 | 46,5 | 78,2 | 57,0 | - | 45,0 | 78,2 | 57,0 | 39,6 | 43,1 | 30 |
| 34 | 34,5 | 45,9 | 73,2 | 54,0 | - | 44,4 | 73,7 | 54,2 | 32,2 | 42,6 | 34 |
| 38 | 27,9 | 45,2 | 69,0 | 51,2 | - | 43,9 | 69,5 | 51,7 | 25,6 | 42,1 | 38 |
| 42 | 22,2 | 44,5 | 65,1 | 49,0 | - | 43,3 | 65,6 | 49,4 | 20,0 | 41,5 | 42 |
| 46 | 17,6 | 43,7 | 61,5 | 47,1 | - | 42,5 | 62,0 | 47,3 | 15,4 | 40,8 | 46 |
| 50 | 13,4 | 42,9 | 58,5 | 45,1 | - | 41,8 | 59,0 | 45,3 | 11,3 | 40,1 | 50 |
| 54 | 9,7 | 42,1 | 55,8 | 43,3 | - | 41,2 | 56,1 | 43,5 | 7,7 | 39,5 | 54 |
| 58 | 6,6 | 40,9 | 53,5 | 41,6 | - | 40,2 | 53,5 | 41,9 | 4,5 | 38,8 | 58 |
| 59 | 5,8 | 40,6 | 52,8 | 41,2 | - | 40,0 | 53,0 | 41,5 | 3,8 | 38,6 | 59 |
| 62 | 3,7 | 39,7 | 51,0 | 40,1 | - | 39,3 | 51,5 | 40,3 | - | 38,0 | 62 |
| 66 | - | 38,7 | 49,0 | 38,7 | - | 38,5 | 49,5 | 39,0 | - | 37,3 | 66 |
| 70 | - | 37,6 | 47,0 | 37,4 | - | 37,6 | 47,5 | 37,6 | - | 36,6 | 70 |
| 74 | - | 36,6 | 45,2 | 36,2 | - | 36,8 | 45,7 | 36,4 | - | 35,8 | 74 |
| 78 | - | 35,7 | 43,6 | 35,0 | - | 36,0 | 44,0 | 35,3 | - | 35,2 | 78 |
| 82 | - | 34,8 | 42,0 | 34,0 | - | 35,0 | 42,4 | 34,2 | - | 34,2 | 82 |
| 86 | - | 33,9 | 40,6 | 33,0 | - | 34,3 | 41,0 | 33,2 | - | 33,5 | 86 |
| 90 | - | 33,1 | 39,3 | 32,1 | - | 33,5 | 39,7 | 32,3 | - | 32,8 | 90 |
| 94 | - | 32,3 | 38,0 | 31,2 | - | 32,5 | 38,4 | 31,5 | - | 31,8 | 94 |
| 98 | - | 31,5 | 36,9 | 30,4 | - | 31,9 | 37,2 | 30,7 | - | 31,1 | 98 |
| 102 | - | 30,9 | 35,8 | 29,7 | - | 31,2 | 36,2 | 29,9 | - | 30,5 | 102 |
| 106 | - | 30,2 | 34,8 | 29,0 | - | 30,5 | 35,2 | 29,2 | - | 29,6 | 106 |
| 110 | - | 29,6 | 33,9 | 28,4 | - | 29,8 | 34,2 | 28,6 | - | 28,8 | 110 |
| 114 | - | 29,2 | 32,5 | 27,8 | - | 29,2 | 31,9 | 28,0 | - | 28,3 | 114 |
| 118 | - | 28,5 | 30,1 | 27,3 | - | 28,8 | 28,3 | 27,5 | - | 27,8 | 118 |
| 122 | - | 28,1 | 27,3 | 26,7 | - | 28,0 | 25,5 | 25,8 | - | 27,0 | 122 |
| 126 | - | 27,7 | 24,6 | 25,2 | - | 26,6 | 22,9 | 23,6 | - | 25,3 | 126 |
| 130 | - | 25,5 | 22,0 | 22,7 | - | 24,2 | 20,4 | 21,1 | - | 22,9 | 130 |
| 134 | - | 23,3 | 19,6 | 20,3 | - | 21,9 | 18,0 | 18,6 | - | 20,7 | 134 |
| 138 | - | 21,1 | 17,4 | 18,0 | - | 19,8 | 15,7 | 16,3 | - | 18,6 | 138 |
| 142 | - | 19,1 | 15,2 | 15,8 | - | 17,8 | 13,6 | 14,1 | - | 16,6 | 142 |
| 146 | - | 17,2 | 13,2 | 13,8 | - | 15,9 | 11,5 | 12,1 | - | 14,7 | 146 |
| 148 | - | 16,3 | 12,3 | 12,8 | - | 15,0 | 10,6 | 11,1 | - | 13,8 | 148 |
| 150 | - | 15,5 | 11,4 | 11,8 | - | 14,2 | 9,7 | 10,1 | - | 13,0 | 150 |
| 151 | - | - | 10,9 | - | - | 13,7 | 9,2 | 9,7 | - | 12,5 | 151 |
| 153 | - | - | 10,1 | - | - | 12,9 | 8,3 | 8,8 | - | 11,7 | 153 |
| 154 | - | - | 9,7 | - | - | - | 7,9 | - | - | 11,3 | 154 |
| 155 | - | - | 9,2 | - | - | - | 7,5 | - | - | 10,9 | 155 |
| 156 | - | - | - | - | - | - | 7,1 | - | - | - | 156 |
| 157 | - | - | - | - | - | - | 6,7 | - | - | - | 157 |
| 158 | - | - | - | - | - | - | - | - | - | - | 158 |
| 160 | - | - | - | - | - | - | - | - | - | - | 160 |

0 t 65 t 95 t 125 t 165 t 205 t 265 t 325 t

LSL+LF_14: 225 t + 50 t

| 165 t + 50 t | | 8,40 m | | 9.8 m/s | | 360° | | ISO | | |
|--------------|------|-----------|------|---------|------|-----------|------|------|------|------|
| 72 m | | 78 m | | 84 m | | 90 m | | 96 m | | |
| LSL+LF_2 | | | | | | | | | | |
| 36 m | | | | | | | | | | |
| 0 t | | 0 t-325 t | | 0 t | | 0 t-325 t | | 0 t | | |
| 15° | | 20° | | 30° | | 15° | | 20° | | |
| 30° | | 15° | | 20° | | 30° | | 15° | | |
| 20° | | 30° | | 15° | | 20° | | 30° | | |
| m | t | t | t | t | t | t | t | t | t | m |
| 20 | 52,0 | 52,0 | - | - | - | - | - | - | - | 20 |
| 21 | 50,7 | 50,8 | - | - | 51,0 | 51,0 | - | - | 51,0 | 51,5 |
| 22 | 49,4 | 49,6 | - | - | 49,8 | 50,0 | - | - | 50,0 | 50,0 |
| 23 | 48,2 | 48,4 | 38,4 | - | 48,6 | 48,8 | - | - | 48,9 | 49,0 |
| 24 | 47,0 | 47,2 | 37,6 | - | 47,5 | 47,7 | 37,8 | - | 47,8 | 48,1 |
| 25 | 45,9 | 46,1 | 36,8 | - | 46,4 | 46,6 | 37,0 | - | 46,7 | 47,0 |
| 26 | 44,8 | 45,0 | 36,0 | - | 45,3 | 45,6 | 36,2 | - | 45,7 | 46,0 |
| 28 | 42,8 | 43,1 | 34,5 | - | 43,4 | 43,6 | 34,8 | - | 43,9 | 44,1 |
| 29 | 41,9 | 42,1 | 33,8 | 21,8 | 42,5 | 42,7 | 34,2 | 21,8 | 43,0 | 43,2 |
| 30 | 41,0 | 41,2 | 33,2 | 21,5 | 41,7 | 41,9 | 33,6 | 21,5 | 42,2 | 42,4 |
| 31 | 40,2 | 40,3 | 32,6 | 21,1 | 40,9 | 41,1 | 33,0 | 21,2 | 41,4 | 41,6 |
| 34 | 37,8 | 37,9 | 30,8 | 20,2 | 38,5 | 38,7 | 31,3 | 20,3 | 39,1 | 39,3 |
| 38 | 34,8 | 34,9 | 28,7 | 19,0 | 35,6 | 35,7 | 29,2 | 19,1 | 36,3 | 36,5 |
| 42 | 32,2 | 32,3 | 26,8 | 18,0 | 33,0 | 33,1 | 27,3 | 18,1 | 33,8 | 33,9 |
| 46 | 30,0 | 30,1 | 25,2 | 17,0 | 30,8 | 30,9 | 25,7 | 17,2 | 31,6 | 31,7 |
| 50 | 28,2 | 28,3 | 23,7 | 16,2 | 28,9 | 29,0 | 24,2 | 16,4 | 29,6 | 29,8 |
| 54 | 26,6 | 26,8 | 22,5 | 15,5 | 27,3 | 27,4 | 23,0 | 15,7 | 27,9 | 28,1 |
| 58 | 25,2 | 25,4 | 21,4 | 14,9 | 25,5 | 26,1 | 22,0 | 15,1 | 25,0 | 26,7 |
| 62 | 23,5 | 24,0 | 20,4 | 14,3 | 23,0 | 24,8 | 21,0 | 14,5 | 22,0 | 25,5 |
| 66 | 21,3 | 22,8 | 19,5 | 13,8 | 19,9 | 23,6 | 20,0 | 14,0 | 18,9 | 24,3 |
| 70 | 18,7 | 21,7 | 18,7 | 13,3 | 17,3 | 22,5 | 19,2 | 13,5 | 16,3 | 23,2 |
| 74 | 16,4 | 20,7 | 17,9 | 12,9 | 14,9 | 21,5 | 18,4 | 13,1 | 13,9 | 22,2 |
| 78 | 14,3 | 19,8 | 17,2 | 12,6 | 12,8 | 20,6 | 17,7 | 12,7 | 11,8 | 21,3 |
| 82 | 12,4 | 19,0 | 16,6 | 12,2 | 10,9 | 19,7 | 17,1 | 12,4 | 9,9 | 20,4 |
| 86 | 10,7 | 18,2 | 16,0 | 12,0 | 9,2 | 18,9 | 16,5 | 12,2 | 8,2 | 19,6 |
| 88 | 9,9 | 17,9 | 15,8 | 12,0 | 8,4 | 18,6 | 16,2 | 12,1 | 7,4 | 19,2 |
| 90 | 9,2 | 17,6 | 15,6 | - | 7,7 | 18,3 | 16,0 | 12,0 | 6,7 | 18,9 |
| 92 | 8,5 | 17,3 | 15,4 | - | 7,0 | 18,0 | 15,8 | 11,9 | 6,0 | 18,6 |
| 94 | 7,8 | 17,0 | 15,2 | - | 6,3 | 17,7 | 15,6 | - | 5,3 | 18,3 |
| 96 | 7,2 | 16,8 | 15,0 | - | 5,6 | 17,4 | 15,4 | - | 4,6 | 18,0 |
| 98 | 6,6 | 16,6 | - | - | 5,0 | 17,1 | 15,2 | - | 4,0 | 17,7 |
| 99 | 6,3 | 16,5 | - | - | 4,7 | 17,0 | 15,1 | - | 3,7 | 17,6 |
| 101 | - | - | - | - | 4,1 | 16,8 | 14,9 | - | - | 17,3 |
| 102 | - | - | - | - | 3,9 | 16,7 | - | - | - | 17,2 |
| 103 | - | - | - | - | 3,6 | 16,6 | - | - | - | 17,0 |
| 104 | - | - | - | - | - | 16,5 | - | - | - | 16,9 |
| 105 | - | - | - | - | - | - | - | - | - | 16,8 |
| 106 | - | - | - | - | - | - | - | - | - | 16,7 |
| 109 | - | - | - | - | - | - | - | - | - | 16,4 |
| 110 | - | - | - | - | - | - | - | - | - | 16,8 |
| 111 | - | - | - | - | - | - | - | - | - | 16,7 |
| 114 | - | - | - | - | - | - | - | - | - | 16,4 |
| 116 | - | - | - | - | - | - | - | - | - | 16,6 |
| 118 | - | - | - | - | - | - | - | - | - | 16,4 |
| 120 | - | - | - | - | - | - | - | - | - | 16,3 |



0 t
65 t
95 t
125 t
165 t
205 t
265 t
325 t

| 165 t + 50 t | | 8,40 m | | 9.8 m/s | | 360° | | ISO | | |
|--------------|------|-----------|------|---------|------|-----------|------|-------|------|-----|
| 102 m | | 108 m | | 114 m | | 120 m | | 126 m | | |
| LSL+LF_2 | | | | | | | | | | |
| 36 m | | | | | | | | | | |
| 0 t | | 0 t-325 t | | 0 t | | 0 t-325 t | | 0 t | | |
| 15° | | 20° | | 30° | | 15° | | 20° | | |
| 30° | | 15° | | 20° | | 30° | | 15° | | |
| 20° | | 30° | | 15° | | 20° | | 30° | | |
| m | t | t | t | t | t | t | t | t | t | m |
| 23 | 49,5 | 49,9 | - | - | - | - | - | - | - | 23 |
| 24 | 48,6 | 48,9 | - | - | 48,7 | 49,1 | - | - | 48,8 | 24 |
| 25 | 47,6 | 47,9 | - | - | 47,8 | 48,2 | - | - | 48,0 | 25 |
| 26 | 46,7 | 47,0 | 36,8 | - | 47,0 | 47,3 | - | - | 47,2 | 26 |
| 27 | 45,8 | 46,1 | 36,2 | - | 46,1 | 46,4 | 36,3 | - | 46,4 | 27 |
| 28 | 45,0 | 45,3 | 35,6 | - | 45,3 | 45,6 | 35,7 | - | 45,6 | 28 |
| 30 | 43,4 | 43,7 | 34,5 | - | 43,8 | 44,1 | 34,6 | - | 44,2 | 30 |
| 31 | 42,7 | 43,0 | 34,0 | 21,2 | 43,1 | 43,4 | 34,1 | - | 43,4 | 31 |
| 32 | 42,0 | 42,3 | 33,5 | 20,9 | 42,4 | 42,7 | 33,6 | 20,9 | 42,7 | 32 |
| 33 | 41,3 | 41,6 | 33,0 | 20,6 | 41,8 | 42,0 | 33,2 | 20,6 | 42,1 | 33 |
| 34 | 40,6 | 40,9 | 32,5 | 20,4 | 41,1 | 41,3 | 32,7 | 20,4 | 41,4 | 34 |
| 38 | 38,1 | 38,3 | 30,6 | 19,4 | 38,0 | 38,3 | 30,9 | 19,5 | 37,5 | 38 |
| 42 | 35,7 | 35,9 | 29,0 | 18,6 | 35,3 | 36,5 | 29,3 | 18,7 | 33,2 | 42 |
| 46 | 31,9 | 33,7 | 27,4 | 17,8 | 30,3 | 34,4 | 27,8 | 17,9 | 28,3 | 46 |
| 50 | 28,2 | 31,8 | 26,0 | 17,0 | 25,9 | 32,5 | 26,4 | 17,1 | 23,9 | 50 |
| 54 | 24,2 | 30,0 | 24,8 | 16,4 | 22,0 | 30,7 | 25,2 | 16,5 | 19,9 | 54 |
| 58 | 20,9 | 28,5 | 23,6 | 15,7 | 18,7 | 29,1 | 24,0 | 15,9 | 16,7 | 58 |
| 62 | 17,9 | 27,2 | 22,6 | 15,1 | 15,7 | 27,7 | 23,0 | 15,3 | 13,7 | 62 |
| 66 | 15,1 | 26,0 | 21,7 | 14,7 | 13,0 | 26,5 | 22,0 | 14,8 | 11,0 | 66 |
| 70 | 12,5 | 24,9 | 20,9 | 14,2 | 10,6 | 25,4 | 21,2 | 14,3 | 8,6 | 70 |
| 74 | 10,2 | 23,9 | 20,1 | 13,7 | 8,4 | 24,4 | 20,4 | 13,9 | 6,5 | 74 |
| 75 | 9,6 | 23,6 | 19,9 | 13,6 | 7,9 | 24,1 | 20,2 | 13,8 | 6,0 | 75 |
| 77 | 8,5 | 23,1 | 19,5 | 13,4 | 6,8 | 23,6 | 19,8 | 13,6 | 5,0 | 77 |
| 78 | 8,0 | 22,9 | 19,4 | 13,3 | 6,3 | 23,4 | 19,7 | 13,5 | 4,5 | 78 |
| 80 | 7,0 | 22,4 | 19,0 | 13,1 | 5,3 | 23,0 | 19,3 | 13,3 | 3,6 | 80 |
| 82 | 6,1 | 22,0 | 18,7 | 12,9 | 4,3 | 22,5 | 19,0 | 13,1 | - | 82 |
| 83 | 5,6 | 21,8 | 18,5 | 12,8 | 3,9 | 22,3 | 18,9 | 13,0 | - | 83 |
| 86 | 4,3 | 21,2 | 18,1 | 12,6 | - | 21,7 | 18,4 | 12,8 | - | 86 |
| 88 | 3,5 | 20,9 | 17,8 | 12,5 | - | 21,3 | 18,1 | 12,6 | - | 88 |
| 90 | - | 20,5 | 17,5 | 12,4 | - | 21,0 | 17,8 | 12,5 | - | 90 |
| 94 | - | 19,8 | 17,0 | 12,1 | - | 20,2 | 17,3 | 12,2 | - | 94 |
| 98 | - | 19,2 | 16,6 | 11,9 | - | 19,6 | 16,8 | 12,0 | - | 98 |
| 102 | - | 18,6 | 16,2 | 11,7 | - | 19,0 | 16,4 | 11,8 | - | 102 |
| 106 | - | 18,1 | 15,8 | 11,5 | - | 18,5 | 16,0 | 11,6 | - | 106 |
| 109 | - | 17,7 | 15,5 | 11,5 | - | 18,1 | 15,8 | 11,5 | - | 109 |
| 110 | - | 17,6 | 15,4 | - | - | 18,0 | 15,7 | 11,5 | - | 110 |
| 114 | - | 17,2 | 15,2 | - | - | 17,6 | 15,4 | 11,4 | - | 114 |
| 118 | - | 16,8 | 14,9 | - | - | 17,2 | 15,1 | - | - | 118 |
| 121 | - | 16,6 | 14,7 | - | - | 16,9 | 14,9 | - | - | 121 |
| 122 | - | 16,5 | - | - | - | 16,8 | 14,9 | - | - | 122 |
| 123 | - | 16,4 | - | - | - | 16,8 | 14,8 | - | - | 123 |
| 125 | - | 16,3 | - | - | - | 16,6 | 14,7 | - | - | 125 |
| 126 | - | - | - | - | - | 16,5 | 14,7 | - | - | 126 |
| 127 | - | - | - | - | - | 16,4 | - | - | - | 127 |
| 130 | - | - | - | - | - | 16,2 | - | - | - | 130 |
| 131 | - | - | - | - | - | - | - | - | - | 131 |
| 134 | - | - | - | - | - | - | - | - | - | 134 |
| 135 | - | - | - | - | - | - | - | - | - | 135 |
| 136 | - | - | - | - | - | - | - | - | - | 136 |
| 138 | - | - | - | - | - | - | - | - | - | 138 |
| 140 | - | - | - | - | - | - | - | - | - | 140 |
| 142 | - | - | - | - | - | - | - | - | - | 142 |
| 146 | - | - | - | - | - | - | - | - | - | 146 |

| | | | | | | | | |
|--|----|-----|-----|------|------|------|------|------|
| | 0t | 65t | 95t | 125t | 165t | 205t | 265t | 325t |
|--|----|-----|-----|------|------|------|------|------|

| 165 t + 50 t | | 8,40 m | | 9.8 m/s | | 360° | | ISO | | | | | |
|--------------|------|---------|------|---------|------|-------|---------|------|------|------|------|---------|-----|
| 132 m | | 138 m | | | | 144 m | | | | | | | |
| LSL+LF 2 | | | | | | | | | | | | | |
| 36 m | | | | | | | | | | | | | |
| 0 t | | 0t-325t | | | 0 t | | 0t-325t | | | 0 t | | 0t-325t | |
| 15° | | 20° | 30° | 15° | | 20° | 30° | 15° | | 20° | 30° | | |
| m | t | t | t | t | t | t | t | t | t | t | t | t | m |
| 26 | 40,5 | 42,3 | - | - | 36,5 | 37,9 | - | - | - | - | - | - | 26 |
| 27 | 40,5 | 42,2 | - | - | 36,5 | 37,8 | - | - | 32,5 | 33,7 | - | - | 27 |
| 28 | 40,5 | 42,2 | - | - | 36,5 | 37,8 | - | - | 32,5 | 33,6 | - | - | 28 |
| 29 | 40,4 | 42,0 | 34,5 | - | 36,5 | 37,7 | 32,7 | - | 32,4 | 33,5 | - | - | 29 |
| 30 | 40,4 | 41,8 | 34,1 | - | 36,5 | 37,7 | 32,6 | - | 32,4 | 33,4 | 29,4 | - | 30 |
| 34 | 37,8 | 40,6 | 32,6 | 20,1 | 34,9 | 37,1 | 31,6 | - | 31,8 | 32,9 | 29,1 | - | 34 |
| 35 | 37,6 | 40,3 | 32,2 | 19,9 | 34,8 | 37,0 | 31,4 | 19,8 | 31,6 | 32,8 | 29,0 | 19,6 | 35 |
| 38 | 34,5 | 39,1 | 31,2 | 19,3 | 31,8 | 36,3 | 30,6 | 19,2 | 28,9 | 32,4 | 28,7 | 19,0 | 38 |
| 42 | 28,8 | 37,2 | 29,8 | 18,7 | 27,6 | 35,3 | 29,4 | 18,5 | 26,1 | 31,8 | 28,2 | 18,3 | 42 |
| 46 | 24,1 | 35,4 | 28,4 | 18,0 | 23,0 | 34,0 | 28,1 | 17,8 | 21,5 | 31,1 | 27,2 | 17,6 | 46 |
| 50 | 19,9 | 33,6 | 27,2 | 17,3 | 18,8 | 32,8 | 26,9 | 17,2 | 17,3 | 30,4 | 26,2 | 17,0 | 50 |
| 54 | 16,1 | 32,0 | 26,0 | 16,7 | 15,1 | 31,6 | 25,8 | 16,6 | 13,7 | 29,8 | 25,3 | 16,5 | 54 |
| 58 | 12,9 | 30,5 | 24,9 | 16,1 | 11,9 | 30,4 | 24,7 | 16,0 | 10,6 | 28,9 | 24,4 | 15,9 | 58 |
| 62 | 10,0 | 29,1 | 23,9 | 15,6 | 9,1 | 29,2 | 23,7 | 15,5 | 7,8 | 28,0 | 23,6 | 15,3 | 62 |
| 66 | 7,4 | 27,8 | 22,9 | 15,1 | 6,5 | 28,1 | 22,8 | 15,0 | 5,2 | 27,1 | 22,8 | 14,9 | 66 |
| 68 | 6,2 | 27,2 | 22,4 | 14,8 | 5,3 | 27,5 | 22,4 | 14,7 | 4,0 | 26,6 | 22,4 | 14,6 | 68 |
| 70 | 5,1 | 26,6 | 22,0 | 14,6 | 4,2 | 26,9 | 22,0 | 14,5 | - | 26,2 | 22,0 | 14,4 | 70 |
| 71 | 4,5 | 26,3 | 21,8 | 14,5 | 3,7 | 26,6 | 21,8 | 14,4 | - | 26,0 | 21,8 | 14,3 | 71 |
| 72 | 4,0 | 26,0 | 21,6 | 14,4 | - | 26,4 | 21,6 | 14,3 | - | 25,8 | 21,6 | 14,2 | 72 |
| 74 | - | 25,5 | 21,2 | 14,2 | - | 25,8 | 21,2 | 14,1 | - | 25,3 | 21,2 | 14,0 | 74 |
| 78 | - | 24,5 | 20,5 | 13,8 | - | 24,8 | 20,5 | 13,7 | - | 24,4 | 20,5 | 13,7 | 78 |
| 82 | - | 23,7 | 19,9 | 13,4 | - | 23,8 | 19,9 | 13,3 | - | 23,5 | 19,7 | 13,3 | 82 |
| 86 | - | 22,9 | 19,3 | 13,0 | - | 22,9 | 19,3 | 13,0 | - | 22,6 | 19,1 | 12,9 | 86 |
| 90 | - | 22,1 | 18,7 | 12,7 | - | 22,2 | 18,7 | 12,7 | - | 21,8 | 18,6 | 12,7 | 90 |
| 94 | - | 21,4 | 18,1 | 12,4 | - | 21,5 | 18,1 | 12,4 | - | 21,0 | 18,0 | 12,3 | 94 |
| 98 | - | 20,8 | 17,6 | 12,2 | - | 20,9 | 17,6 | 12,1 | - | 20,3 | 17,5 | 12,1 | 98 |
| 102 | - | 20,2 | 17,1 | 11,9 | - | 20,3 | 17,2 | 11,9 | - | 19,7 | 17,1 | 11,9 | 102 |
| 106 | - | 19,6 | 16,7 | 11,7 | - | 19,7 | 16,8 | 11,7 | - | 19,0 | 16,7 | 11,6 | 106 |
| 110 | - | 19,0 | 16,3 | 11,5 | - | 19,1 | 16,4 | 11,5 | - | 18,4 | 16,3 | 11,4 | 110 |
| 114 | - | 18,6 | 16,0 | 11,4 | - | 18,7 | 16,0 | 11,4 | - | 17,9 | 16,0 | 11,3 | 114 |
| 118 | - | 18,1 | 15,6 | 11,2 | - | 18,2 | 15,7 | 11,2 | - | 17,4 | 15,6 | 11,1 | 118 |
| 122 | - | 17,7 | 15,3 | 11,1 | - | 17,8 | 15,4 | 11,1 | - | 16,9 | 15,3 | 11,0 | 122 |
| 126 | - | 17,4 | 15,1 | 11,1 | - | 17,5 | 15,2 | 11,0 | - | 16,4 | 15,1 | 10,9 | 126 |
| 130 | - | 17,0 | 14,9 | 11,0 | - | 17,1 | 15,0 | 10,9 | - | 16,1 | 14,9 | 10,8 | 130 |
| 132 | - | 16,9 | 14,8 | 10,9 | - | 17,0 | 14,9 | 10,9 | - | 16,0 | 14,8 | 10,8 | 132 |
| 134 | - | 16,8 | 14,8 | - | - | 16,8 | 14,8 | 10,9 | - | 15,9 | 14,7 | 10,7 | 134 |
| 136 | - | 16,7 | 14,7 | - | - | 16,7 | 14,7 | 10,8 | - | 15,8 | 14,6 | 10,7 | 136 |
| 138 | - | 16,6 | 14,6 | - | - | 16,6 | 14,6 | - | - | 15,8 | 14,5 | 10,7 | 138 |
| 141 | - | 16,4 | 14,5 | - | - | 16,4 | 14,5 | - | - | 15,7 | 14,4 | 10,7 | 141 |
| 142 | - | 16,4 | 14,5 | - | - | 16,4 | 14,4 | - | - | 15,6 | 14,3 | - | 142 |
| 146 | - | 16,2 | 14,4 | - | - | 16,2 | 14,3 | - | - | 15,5 | 14,3 | - | 146 |
| 147 | - | 16,2 | 14,4 | - | - | 16,2 | 14,3 | - | - | 15,5 | 14,2 | - | 147 |
| 150 | - | 16,1 | - | - | - | 16,1 | 14,3 | - | - | 15,5 | 14,2 | - | 150 |
| 151 | - | 16,0 | - | - | - | 16,0 | 14,3 | - | - | 15,5 | 14,1 | - | 151 |
| 152 | - | - | - | - | - | 16,0 | 14,3 | - | - | 15,5 | 14,1 | - | 152 |
| 154 | - | - | - | - | - | 16,0 | - | - | - | 15,5 | 14,1 | - | 154 |
| 156 | - | - | - | - | - | 16,0 | - | - | - | 15,5 | 14,1 | - | 156 |
| 158 | - | - | - | - | - | - | - | - | - | 15,5 | 5,5 | - | 158 |
| 161 | - | - | - | - | - | - | - | - | - | 15,5 | - | - | 161 |

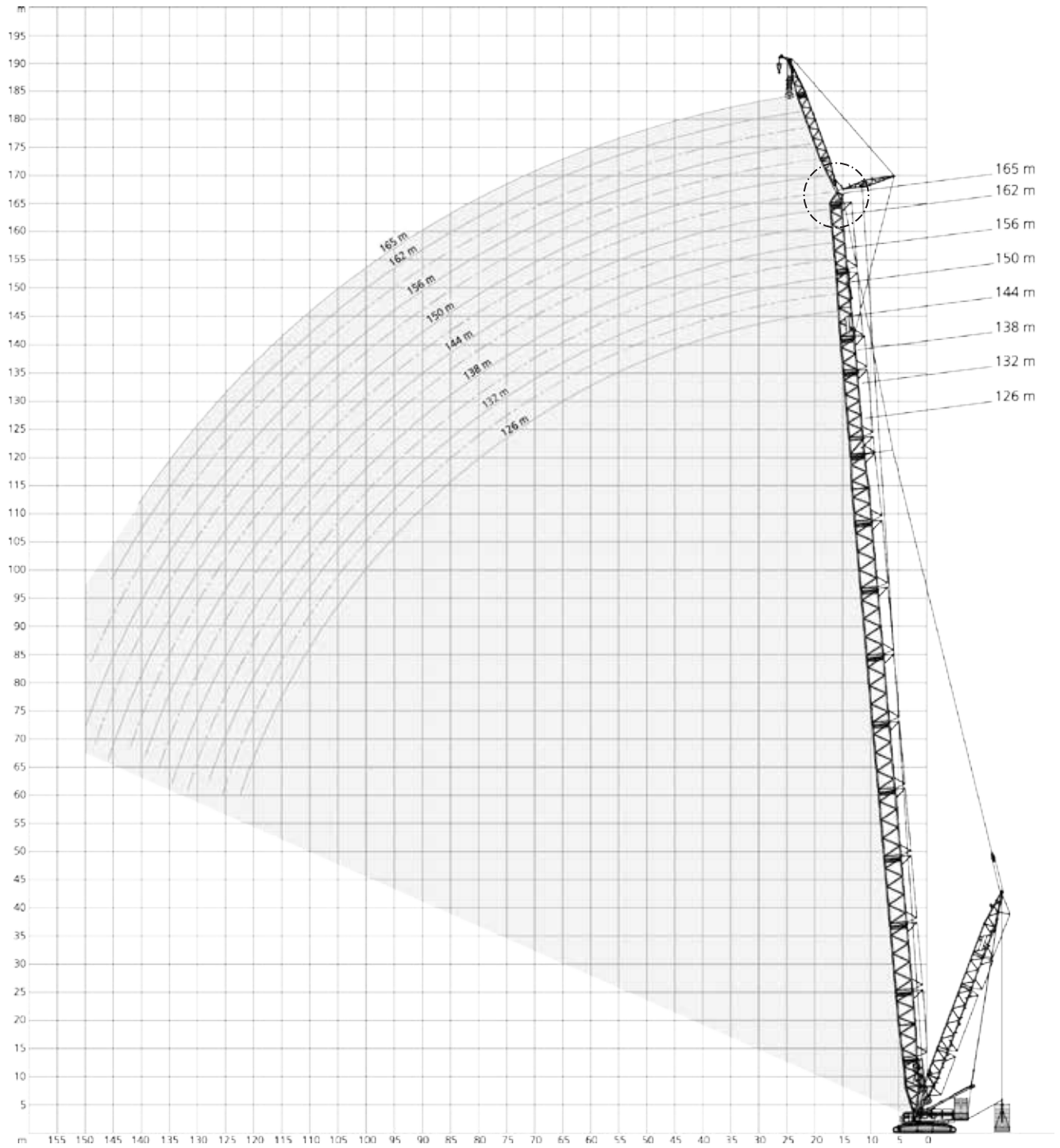
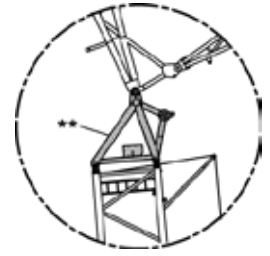
0t
65t
95t
125t
165t
205t
265t
325t



** Option · Option · En option · Opzione · Orcion · Orcional · Опция

Notes

CC 3800-1

Notizen · Notes · Nota · Notas · Notas ·
пометы, комментарии, примечания

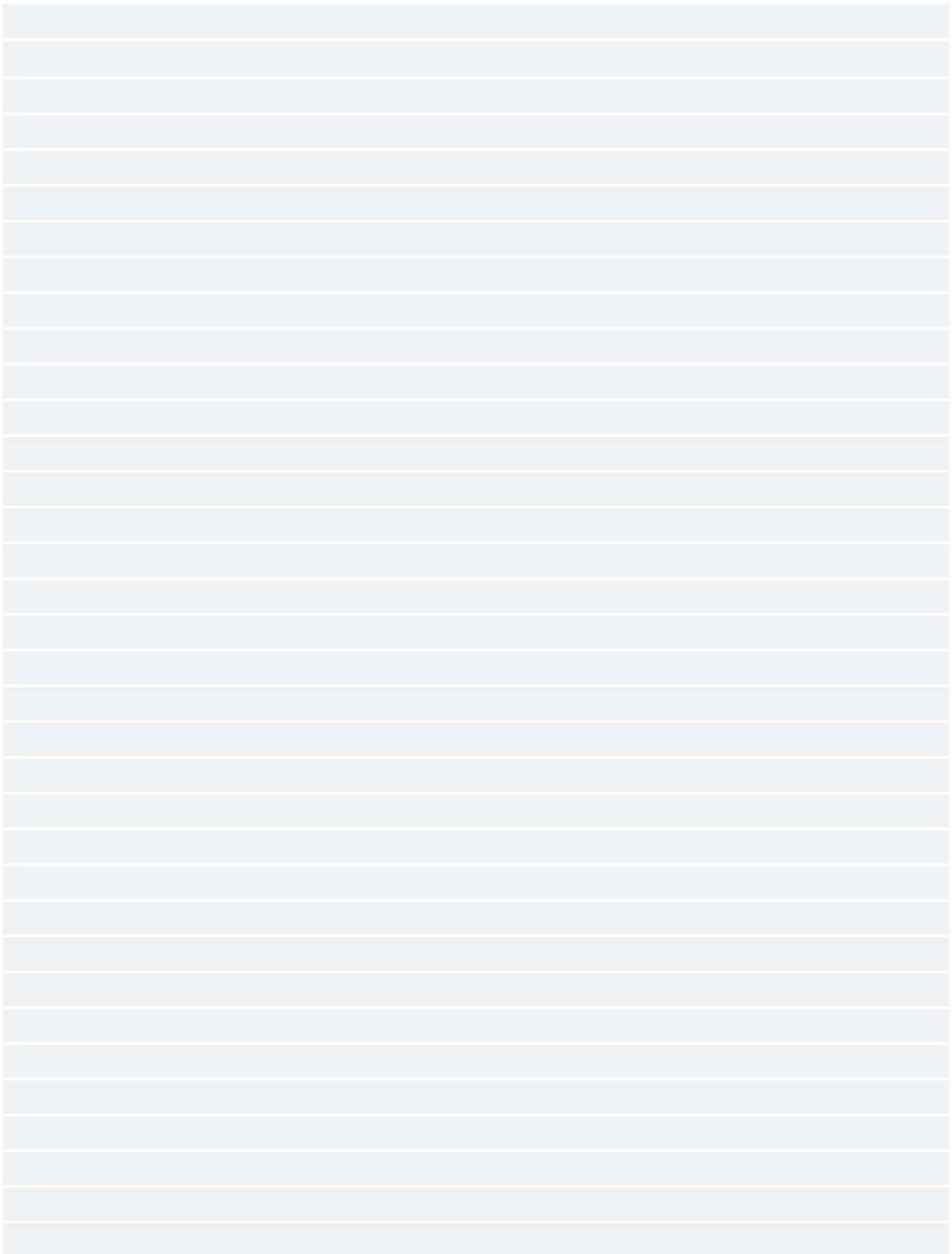

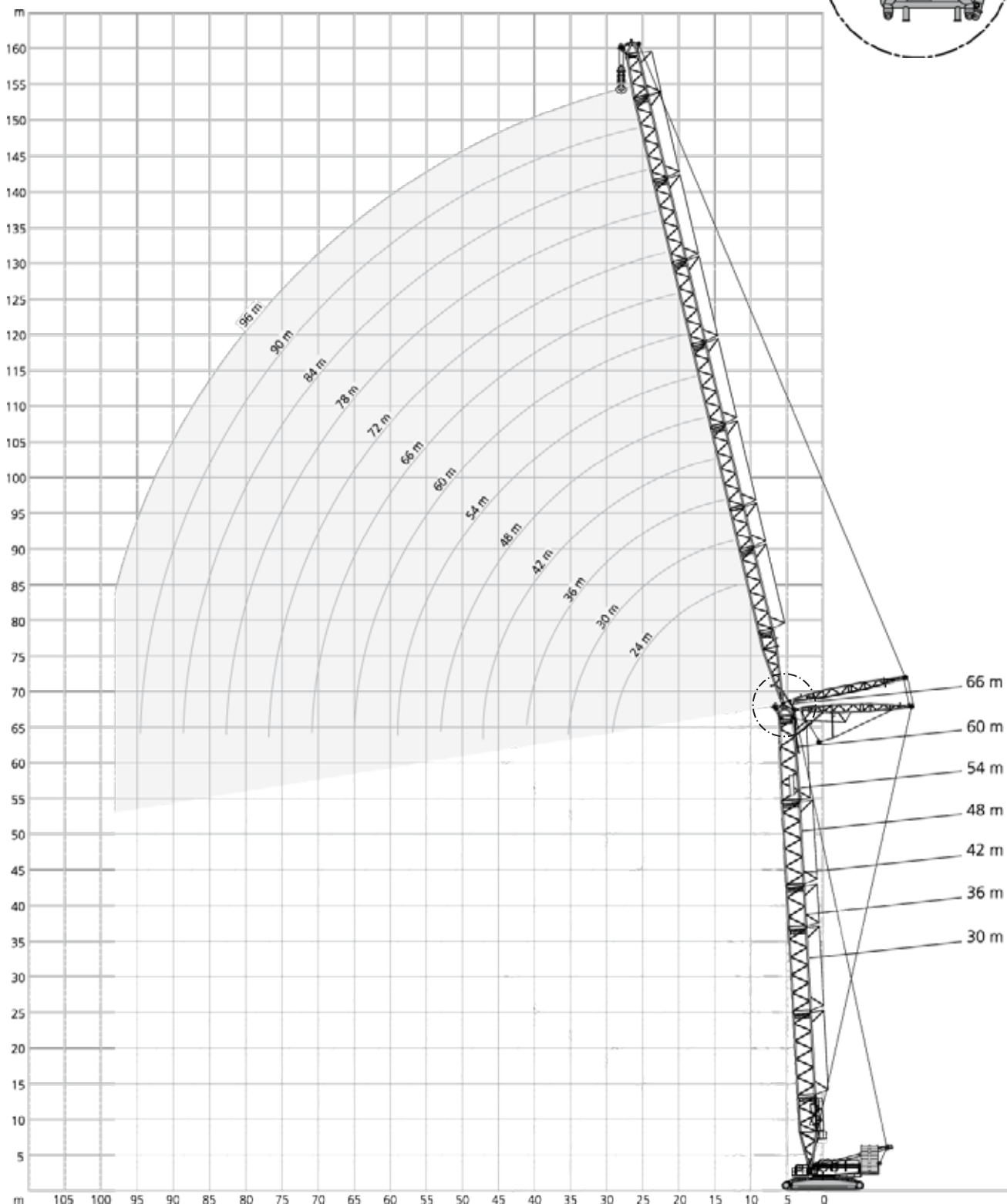
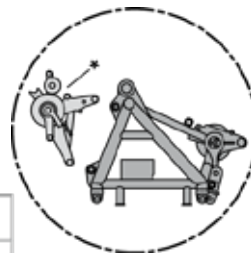

* Attachable · Anbaubar · Amovible · Montabile · Acoplable · Adaptável · Приставн

| 205 t + 50 t | | 8,40 m | | 9.8 m/s | | 360° | | ISO | | | | | | | | | |
|--------------|-------|--------|------|---------|------|------|-------|------|---------|-------|------|------|-------|------|------|---|---|
| 36 m | | | | | | | | | | | | | | | | | |
| 24 m | | | 30 m | | | 36 m | | | 42 m | | | 48 m | | | | | |
| SW_1 | | | | | | | | | | | | | | | | | |
| 87°/85° | | | 75° | | | 65° | | | 87°/85° | | | 75° | | | 65° | | |
| m | t | t | t | t | t | t | t | t | t | t | t | t | t | t | t | t | t |
| 11 | 269,0 | - | - | - | - | - | - | - | - | - | - | - | - | - | - | - | - |
| 12 | 247,0 | - | - | 236,0 | - | - | - | - | - | - | - | - | - | - | - | - | - |
| 14 | 213,0 | - | - | 204,0 | - | - | 196,0 | - | - | - | - | - | - | - | - | - | - |
| 15 | 199,0 | - | - | 191,0 | - | - | 183,0 | - | - | 177,0 | - | - | - | - | - | - | - |
| 16 | 186,0 | - | - | 179,0 | - | - | 172,0 | - | - | 166,0 | - | - | - | - | - | - | - |
| 17 | 176,0 | - | - | 169,0 | - | - | 162,0 | - | - | 157,0 | - | - | 151,0 | - | - | - | - |
| 18 | 166,0 | - | - | 160,0 | - | - | 154,0 | - | - | 149,0 | - | - | 143,0 | - | - | - | - |
| 20 | 148,0 | - | - | 144,0 | - | - | 139,0 | - | - | 134,0 | - | - | 129,0 | - | - | - | - |
| 22 | 129,0 | - | - | 128,0 | - | - | 126,0 | - | - | 122,0 | - | - | 117,0 | - | - | - | - |
| 23 | 122,0 | 109,0 | - | 121,0 | - | - | 120,0 | - | - | 117,0 | - | - | 112,0 | - | - | - | - |
| 24 | 115,0 | 103,0 | - | 114,0 | - | - | 114,0 | - | - | 112,0 | - | - | 107,0 | - | - | - | - |
| 26 | 103,0 | 93,0 | - | 102,0 | 91,5 | - | 102,0 | - | - | 101,0 | - | - | 99,5 | - | - | - | - |
| 28 | 92,5* | 84,0 | - | 93,0 | 83,0 | - | 92,5 | 82,0 | - | 92,0 | - | - | 91,0 | - | - | - | - |
| 30 | - | 77,0 | - | 85,0 | 75,5 | - | 84,0 | 74,5 | - | 84,0 | - | - | 82,5 | - | - | - | - |
| 31 | - | 74,0 | - | 81,6 | 72,5 | - | 80,8 | 71,5 | - | 80,7 | 70,5 | - | 79,2 | - | - | - | - |
| 33 | - | 68,0 | 61,0 | 75,0 | 66,5 | - | 74,6 | 65,5 | - | 74,2 | 64,8 | - | 72,7 | 63,0 | - | - | - |
| 34 | - | 65,0 | 58,5 | 70,5* | 63,5 | - | 71,5 | 62,5 | - | 71,0 | 62,0 | - | 69,5 | 60,5 | - | - | - |
| 35 | - | 62,5 | 56,5 | - | 61,3 | - | 69,0 | 60,3 | - | 68,5 | 59,7 | - | 67,0 | 58,2 | - | - | - |
| 36 | - | - | 54,5 | - | 59,2 | 53,0 | 66,5 | 58,2 | - | 66,0 | 57,5 | - | 64,5 | 56,0 | - | - | - |
| 38 | - | - | 50,5 | - | 55,0 | 49,2 | 61,5 | 54,0 | - | 61,0 | 53,0 | - | 59,5 | 51,5 | - | - | - |
| 40 | - | - | 47,4 | - | 51,5 | 45,9 | 56,0* | 50,5 | 44,7 | 57,0 | 49,7 | - | 55,7 | 48,2 | - | - | - |
| 41 | - | - | 45,9 | - | - | 44,3 | - | 48,8 | 43,2 | 55,0 | 48,1 | - | 53,8 | 46,5 | - | - | - |
| 42 | - | - | - | - | - | 42,9 | - | 47,1 | 41,7 | 53,0 | 46,5 | - | 52,0 | 44,9 | - | - | - |
| 43 | - | - | - | - | - | 41,6 | - | 45,7 | 40,4 | 51,5 | 45,1 | 39,6 | 50,4 | 43,5 | - | - | - |
| 46 | - | - | - | - | - | 37,9 | - | 41,7 | 36,7 | 46,3* | 40,9 | 35,9 | 45,9 | 39,3 | - | - | - |
| 47 | - | - | - | - | - | - | - | - | 35,6 | - | 39,7 | 34,8 | 44,6 | 38,1 | 32,7 | - | - |
| 50 | - | - | - | - | - | - | - | - | 32,6 | - | 36,4 | 31,6 | 40,9 | 34,8 | 29,6 | - | - |
| 52 | - | - | - | - | - | - | - | - | 30,8 | - | 34,5 | 29,8 | 37,7* | 32,9 | 27,8 | - | - |
| 54 | - | - | - | - | - | - | - | - | - | - | 28,1 | - | 31,0 | 26,0 | - | - | - |
| 58 | - | - | - | - | - | - | - | - | - | - | 25,2 | - | 28,0 | 23,0 | - | - | - |
| 62 | - | - | - | - | - | - | - | - | - | - | - | - | - | 20,6 | - | - | - |
| 64 | - | - | - | - | - | - | - | - | - | - | - | - | - | 19,5 | - | - | - |

* Main boom angle 85° · Hauptauslegerwinkel 85° · Jarret de flèche principale 85° · Inclinazione braccio base 85° ·
 Ângulo de pluma principal 85° · Ângulo da lança principal 85° · Угол подъема гл. стрелы 85°

Main boom angle 87°, 85°, 75° and 65°, capacities for intermediate boom positions are calculated by the crane control system IC-1 ·
 Hauptauslegerwinkel 87°, 85°, 75° und 65°, Traglasten für Zwischenstellungen des Hauptauslegers werden von der Kransteuerung IC-1
 berechnet · Jarret de flèche principale 87°, 85°, 75° et 65°, le système de commande de la grue IC-1 calcule les charges pour les positions
 intermédiaires de la flèche · Inclinazione braccio base 87°, 85°, 75° e 65°, capacità per posizioni intermedie del braccio sono calcolate dal
 sistema di controllo della gru IC-1 · Ângulo de pluma principal 87°, 85°, 75° y 65°, las capacidades para posiciones de pluma intermedias
 son calculadas por el sistema de control de grúa IC-1 · Ângulos da lança principal 87°, 85°, 75° e 65°, as capacidades para posições da
 lança intermediária são calculadas pelo sistema de controle da grua IC-1 · Грузоподъемность при углах подъема главной стрелы
 87°, 85°, 75° и 65°, грузоподъемность в промежуточных положениях стрелы рассчитывается системой управления краном IC-1

| 205 t + 50 t | | 8,40 m | | 9.8 m/s | | 360° | | ISO | | | | | | | | | |
|--------------|-------|--------|------|---------|------|------|-------|------|---------|-------|------|------|---|---|-----|---|--|
| 36 m | | | | | | | | | | | | | | | | | |
| 54 m | | | 60 m | | | 66 m | | | 72 m | | | | | | | | |
| SW_1 | | | | | | | | | | | | | | | | | |
| 87°/85° | | | 75° | | | 65° | | | 87°/85° | | | 75° | | | 65° | | |
| m | t | t | t | t | t | t | t | t | t | t | t | t | t | t | t | t | |
| 18 | 138,0 | - | - | - | - | - | - | - | - | - | - | - | - | - | - | - | |
| 19 | 131,0 | - | - | 126,0 | - | - | - | - | - | - | - | - | - | - | - | - | |
| 20 | 125,0 | - | - | 120,0 | - | - | - | - | - | - | - | - | - | - | - | - | |
| 21 | 119,5 | - | - | 115,0 | - | - | 111,0 | - | - | - | - | - | - | - | - | - | |
| 22 | 114,0 | - | - | 110,0 | - | - | 106,0 | - | - | 99,0 | - | - | - | - | - | - | |
| 24 | 104,0 | - | - | 101,0 | - | - | 97,5 | - | - | 94,0 | - | - | - | - | - | - | |
| 26 | 96,0 | - | - | 93,0 | - | - | 90,0 | - | - | 87,0 | - | - | - | - | - | - | |
| 28 | 89,0 | - | - | 86,0 | - | - | 83,5 | - | - | 80,5 | - | - | - | - | - | - | |
| 30 | 82,5 | - | - | 80,0 | - | - | 77,5 | - | - | 74,5 | - | - | - | - | - | - | |
| 34 | 69,5 | - | - | 68,5 | - | - | 67,5 | - | - | 65,0 | - | - | - | - | - | - | |
| 36 | 64,5 | 55,5 | - | 63,5 | - | - | 62,7 | - | - | 61,0 | - | - | - | - | - | - | |
| 38 | 59,5 | 51,5 | - | 58,5 | - | - | 58,0 | - | - | 57,0 | - | - | - | - | - | - | |
| 39 | 57,5 | 49,7 | - | 56,6 | 48,7 | - | 56,1 | - | - | 55,2 | - | - | - | - | - | - | |
| 41 | 53,5 | 46,3 | - | 52,8 | 45,3 | - | 52,3 | 44,4 | - | 51,6 | - | - | - | - | - | - | |
| 42 | 51,5 | 44,6 | - | 51,0 | 43,6 | - | 50,5 | 42,9 | - | 49,9 | - | - | - | - | - | - | |
| 44 | 48,5 | 41,7 | - | 47,8 | 40,8 | - | 47,3 | 40,1 | - | 46,7 | 39,1 | - | - | - | - | - | |
| 46 | 45,6 | 39,0 | - | 44,7 | 38,0 | - | 44,2 | 37,3 | - | 43,5 | 36,5 | - | - | - | - | - | |
| 50 | 40,5 | 34,4 | 29,1 | 39,6 | 33,4 | - | 39,0 | 32,6 | - | 38,3 | 31,7 | - | - | - | - | - | |
| 53 | 37,2 | 31,5 | 26,4 | 36,3 | 30,4 | 25,0 | 35,7 | 29,6 | - | 35,0 | 28,7 | - | - | - | - | - | |
| 54 | 36,2 | 30,6 | 25,5 | 35,3 | 29,5 | 24,2 | 34,6 | 28,6 | - | 34,0 | 27,7 | - | - | - | - | - | |
| 57 | 32,6* | 28,1 | 23,2 | 32,5 | 26,8 | 21,8 | 31,8 | 26,0 | 20,9 | 31,2 | 25,0 | - | - | - | - | - | |
| 58 | - | 27,3 | 22,5 | 31,6 | 26,0 | 21,1 | 31,0 | 25,2 | 20,1 | 30,3 | 24,2 | - | - | - | - | - | |
| 60 | - | 25,8 | 21,2 | 30,0 | 24,5 | 19,8 | 29,4 | 23,7 | 18,8 | 28,7 | 22,7 | 17,7 | - | - | - | - | |
| 62 | - | 24,4 | 19,9 | 28,6 | 23,1 | 18,5 | 27,8 | 22,2 | 17,5 | 27,1 | 21,3 | 16,5 | - | - | - | - | |
| 63 | - | 23,8 | 19,3 | 27,1* | 22,5 | 17,9 | 27,1 | 21,5 | 16,9 | 26,4 | 20,6 | 15,9 | - | - | - | - | |
| 64 | - | 23,2 | 18,8 | - | 21,9 | 17,4 | 26,5 | 20,9 | 16,4 | 25,7 | 20,0 | 15,3 | - | - | - | - | |
| 66 | - | - | 17,7 | - | 20,7 | 16,3 | 25,2 | 19,7 | 15,3 | 24,4 | 18,7 | 14,2 | - | - | - | - | |
| 69 | - | - | 16,3 | - | 19,1 | 14,8 | 22,6* | 18,0 | 13,8 | 22,4 | 17,0 | 12,7 | - | - | - | - | |
| 70 | - | - | 15,9 | - | - | 14,4 | - | 17,5 | 13,4 | 21,8 | 16,5 | 12,2 | - | - | - | - | |
| 74 | - | - | - | - | - | 12,7 | - | 15,7 | 11,7 | 18,8* | 14,5 | 10,5 | - | - | - | - | |
| 75 | - | - | - | - | - | 12,4 | - | 15,3 | 11,3 | 18,3* | 14,0 | 10,1 | - | - | - | - | |
| 78 | - | - | - | - | - | - | - | - | 10,2 | - | 12,8 | 9,0 | - | - | - | - | |
| 81 | - | - | - | - | - | - | - | - | 9,3 | - | 11,7 | 8,0 | - | - | - | - | |
| 82 | - | - | - | - | - | - | - | - | - | - | - | 7,7 | - | - | - | - | |
| 86 | - | - | - | - | - | - | - | - | - | - | - | 6,5 | - | - | - | - | |
| 87 | - | - | - | - | - | - | - | - | - | - | - | 6,3 | - | - | - | - | |

* Main boom angle 85° · Hauptauslegerwinkel 85° · Jarret de flèche principale 85° · Inclinação braccio base 85° ·
 Ángulo de pluma principal 85° · Ângulo da lança principal 85° · Угол подъема гл. стрелы 85°

Main boom angle 87°, 85°, 75° and 65°, capacities for intermediate boom positions are calculated by the crane control system IC-1 ·
 Hauptauslegerwinkel 87°, 85°, 75° und 65°, Traglasten für Zwischenstellungen des Hauptauslegers werden von der Kransteuerung IC-1
 berechnet · Jarret de flèche principale 87°, 85°, 75° et 65°, le système de commande de la grue IC-1 calcule les charges pour les positions
 intermédiaires de la flèche · Inclinação braccio base 87°, 85°, 75° e 65°, capacità per posizioni intermedie del braccio sono calcolate dal
 sistema di controllo della gru IC-1 · Ángulo de pluma principal 87°, 85°, 75° y 65°, las capacidades para posiciones de pluma intermedias
 son calculadas por el sistema de control de grúa IC-1 · Ângulos da lança principal 87°, 85°, 75° e 65°; as capacidades para posições da
 lança intermediária são calculadas pelo sistema de controle da grua IC-1 · Грузоподъемность при углах подъема главной стрелы
 87°, 85°, 75° и 65°, грузоподъемность в промежуточных положениях стрелы рассчитывается системой управления краном IC-1

| 205 t + 50 t | | 8,40 m | | 9.8 m/s | | 360° | | ISO | | | | | | | | | |
|--------------|-------|--------|------|---------|------|------|------|------|---------|------|------|-----|---|---|-----|---|--|
| 36 m | | | | | | | | | | | | | | | | | |
| 78 m | | | 84 m | | | 90 m | | | 96 m | | | | | | | | |
| SW_1 | | | | | | | | | | | | | | | | | |
| 87°/85° | | | 75° | | | 65° | | | 87°/85° | | | 75° | | | 65° | | |
| m | t | t | t | t | t | t | t | t | t | t | t | t | t | t | t | t | |
| 23 | 84,5 | - | - | - | - | - | - | - | - | - | - | - | - | - | - | - | |
| 24 | 84,0 | - | - | - | - | - | - | - | - | - | - | - | - | - | - | - | |
| 25 | 83,5 | - | - | 71,5 | - | - | - | - | - | - | - | - | - | - | - | - | |
| 26 | 83,0 | - | - | 71,0 | - | - | 61,0 | - | - | - | - | - | - | - | - | - | |
| 27 | 80,2 | - | - | 70,5 | - | - | 60,5 | - | - | 52,5 | - | - | - | - | - | - | |
| 28 | 77,5 | - | - | 70,0 | - | - | 60,0 | - | - | 52,0 | - | - | - | - | - | - | |
| 30 | 72,0 | - | - | 69,5 | - | - | 59,5 | - | - | 51,5 | - | - | - | - | - | - | |
| 34 | 62,5 | - | - | 60,0 | - | - | 58,0 | - | - | 50,5 | - | - | - | - | - | - | |
| 38 | 55,0 | - | - | 52,5 | - | - | 51,0 | - | - | 48,8 | - | - | - | - | - | - | |
| 42 | 48,9 | - | - | 46,7 | - | - | 44,9 | - | - | 42,8 | - | - | - | - | - | - | |
| 46 | 42,9 | 35,5 | - | 41,5 | - | - | 39,8 | - | - | 37,8 | - | - | - | - | - | - | |
| 49 | 39,0 | 31,9 | - | 37,8 | 30,3 | - | 36,5 | - | - | 34,5 | - | - | - | - | - | - | |
| 50 | 37,7 | 30,8 | - | 36,6 | 29,3 | - | 35,4 | - | - | 33,4 | - | - | - | - | - | - | |
| 51 | 36,6 | 29,8 | - | 35,5 | 28,3 | - | 34,4 | 26,9 | - | 32,4 | - | - | - | - | - | - | |
| 54 | 33,3 | 26,8 | - | 32,2 | 25,3 | - | 31,6 | 24,4 | - | 29,7 | 22,4 | - | - | - | - | - | |
| 58 | 29,6 | 23,3 | - | 28,5 | 21,9 | - | 28,0 | 21,1 | - | 26,4 | 19,6 | - | - | - | - | - | |
| 62 | 26,4 | 20,4 | - | 25,2 | 18,9 | - | 24,6 | 18,2 | - | 23,5 | 17,0 | - | - | - | - | - | |
| 64 | 24,9 | 19,1 | 14,3 | 23,6 | 17,6 | - | 23,1 | 16,9 | - | 22,1 | 15,8 | - | - | - | - | - | |
| 66 | 23,5 | 17,8 | 13,2 | 22,2 | 16,4 | - | 21,6 | 15,6 | - | 20,7 | 14,6 | - | - | - | - | - | |
| 67 | 22,9 | 17,2 | 12,7 | 21,5 | 15,8 | 11,2 | 20,9 | 15,0 | - | 20,0 | 14,0 | - | - | - | - | - | |
| 70 | 21,0 | 15,6 | 11,3 | 19,7 | 14,1 | 9,7 | 19,0 | 13,4 | - | 18,1 | 12,3 | - | - | - | - | - | |
| 71 | 20,4 | 15,1 | 10,8 | 19,1 | 13,6 | 9,2 | 18,4 | 12,9 | 8,4 | 17,5 | 11,8 | - | - | - | - | - | |
| 74 | 18,7 | 13,6 | 9,5 | 17,4 | 12,2 | 8,0 | 16,7 | 11,4 | 7,2 | 15,8 | 10,3 | 6,0 | - | - | - | - | |
| 78 | 16,7 | 11,9 | 8,0 | 15,4 | 10,4 | 6,5 | 14,7 | 9,6 | 5,6 | 13,7 | 8,6 | 4,5 | - | - | - | - | |
| 79 | 16,3 | 11,5 | 7,6 | 14,9 | 10,0 | 6,1 | 14,2 | 9,2 | 5,2 | 13,2 | 8,2 | 4,1 | - | - | - | - | |
| 81 | 14,6* | 10,7 | 6,9 | 14,0 | 9,2 | 5,4 | 13,3 | 8,4 | 4,6 | 12,3 | 7,4 | - | - | - | - | - | |
| 82 | - | 10,3 | 6,6 | 13,6 | 8,9 | 5,1 | 12,9 | 8,1 | 4,3 | 11,9 | 7,0 | - | - | - | - | - | |
| 85 | - | 9,3 | 5,7 | 12,5 | 7,8 | 4,2 | 11,7 | 7,0 | - | 10,6 | 5,9 | - | - | - | - | - | |
| 86 | - | 9,0 | 5,4 | 11,3* | 7,5 | - | 11,3 | 6,7 | - | 10,2 | 5,6 | - | - | - | - | - | |
| 87 | - | 8,7 | 5,1 | - | 7,2 | - | 10,9 | 6,3 | - | 9,8 | 5,2 | - | - | - | - | - | |
| 90 | - | - | 4,4 | - | 6,3 | - | 9,8 | 5,4 | - | 8,8 | 4,3 | - | - | - | - | - | |
| 91 | - | - | 4,1 | - | 6,0 | - | 9,5 | 5,1 | - | 8,4 | 4,0 | - | - | - | - | - | |
| 92 | - | - | - | - | 5,7 | - | 8,4* | 4,8 | - | 8,1 | - | - | - | - | - | - | |
| 93 | - | - | - | - | 5,5 | - | - | 4,5 | - | 7,7 | - | - | - | - | - | - | |
| 94 | - | - | - | - | - | - | - | 4,3 | - | 7,4 | - | - | - | - | - | - | |
| 95 | - | - | - | - | - | - | - | 4,0 | - | 7,1 | - | - | - | - | - | - | |
| 98 | - | - | - | - | - | - | - | - | - | 5,5* | - | - | - | - | - | - | |

* Main boom angle 85° · Hauptauslegerwinkel 85° · Jarret de flèche principale 85° · Inclinazione braccio base 85° ·
 Ângulo de pluma principal 85° · Ângulo da lança principal 85° · Угол подъема гл. стрелы 85°

Main boom angle 87°, 85°, 75° and 65°, capacities for intermediate boom positions are calculated by the crane control system IC-1 ·
 Hauptauslegerwinkel 87°, 85°, 75° und 65°, Traglasten für Zwischenstellungen des Hauptauslegers werden von der Kransteuerung IC-1
 berechnet · Jarret de flèche principale 87°, 85°, 75° et 65°, le système de commande de la grue IC-1 calcule les charges pour les positions
 intermédiaires de la flèche · Inclinazione braccio base 87°, 85°, 75° e 65°, capacità per posizioni intermedie del braccio sono calcolate dal
 sistema di controllo della gru IC-1 · Ângulo de pluma principal 87°, 85°, 75° y 65°, las capacidades para posiciones de pluma intermedias
 son calculadas por el sistema de control de grúa IC-1 · Ângulos da lança principal 87°, 85°, 75° e 65°, as capacidades para posições da
 lança intermediária são calculadas pelo sistema de controle da grua IC-1 · Грузоподъемность при углах подъема главной стрелы
 87°, 85°, 75° и 65°, грузоподъемность в промежуточных положениях стрелы рассчитывается системой управления краном IC-1

| 205 t + 50 t | | 8,40 m | | 9.8 m/s | | 360° | | ISO | | | | | | | | | |
|--------------|-------|--------|------|---------|------|------|-------|------|---------|-------|------|------|-------|------|------|---|--|
| 42 m | | | | | | | | | | | | | | | | | |
| 24 m | | | 30 m | | | 36 m | | | 42 m | | | 48 m | | | | | |
| SW_1 | | | | | | | | | | | | | | | | | |
| 87°/85° | | | 75° | | | 65° | | | 87°/85° | | | 75° | | | 65° | | |
| m | t | t | t | t | t | t | t | t | t | t | t | t | t | t | t | t | |
| 12 | 236,0 | - | - | - | - | - | - | - | - | - | - | - | - | - | - | - | |
| 13 | 218,0 | - | - | 209,0 | - | - | - | - | - | - | - | - | - | - | - | - | |
| 14 | 204,0 | - | - | 195,0 | - | - | 188,0 | - | - | - | - | - | - | - | - | - | |
| 15 | 191,0 | - | - | 183,0 | - | - | 176,0 | - | - | 170,0 | - | - | - | - | - | - | |
| 16 | 179,0 | - | - | 172,0 | - | - | 166,0 | - | - | 160,0 | - | - | - | - | - | - | |
| 17 | 169,0 | - | - | 163,0 | - | - | 156,0 | - | - | 151,0 | - | - | 145,0 | - | - | - | |
| 18 | 160,0 | - | - | 154,0 | - | - | 148,0 | - | - | 143,0 | - | - | 138,0 | - | - | - | |
| 20 | 144,0 | - | - | 139,0 | - | - | 134,0 | - | - | 130,0 | - | - | 124,0 | - | - | - | |
| 22 | 129,0 | - | - | 126,0 | - | - | 122,0 | - | - | 118,0 | - | - | 113,0 | - | - | - | |
| 24 | 115,0 | - | - | 113,0 | - | - | 112,0 | - | - | 108,0 | - | - | 104,0 | - | - | - | |
| 25 | 109,0 | 95,0 | - | 107,5 | - | - | 106,5 | - | - | 104,0 | - | - | 100,0 | - | - | - | |
| 26 | 103,0 | 90,0 | - | 102,0 | - | - | 101,0 | - | - | 100,0 | - | - | 96,0 | - | - | - | |
| 28 | 91,5* | 81,5 | - | 92,5 | 80,0 | - | 92,0 | - | - | 91,5 | - | - | 89,0 | - | - | - | |
| 29 | 87,5* | 78,0 | - | 88,5 | 76,5 | - | 87,7 | - | - | 87,5 | - | - | 85,5 | - | - | - | |
| 30 | - | 74,5 | - | 84,5 | 73,0 | - | 83,5 | 72,0 | - | 83,5 | - | - | 82,0 | - | - | - | |
| 33 | - | 65,8 | - | 74,5 | 64,3 | - | 74,1 | 63,3 | - | 73,7 | 62,5 | - | 72,2 | - | - | - | |
| 34 | - | 63,0 | - | 70,0* | 61,5 | - | 71,0 | 60,5 | - | 70,5 | 60,0 | - | 69,0 | - | - | - | |
| 35 | - | 60,5 | - | 67,0* | 59,3 | - | 68,5 | 58,3 | - | 68,0 | 57,7 | - | 66,5 | 56,0 | - | - | |
| 36 | - | 58,0 | 51,0 | - | 57,2 | - | 66,0 | 56,2 | - | 65,5 | 55,5 | - | 64,0 | 53,9 | - | - | |
| 38 | - | - | 47,6 | - | 53,0 | - | 61,0 | 52,0 | - | 60,5 | 51,0 | - | 59,0 | 49,8 | - | - | |
| 39 | - | - | 46,0 | - | 51,3 | 44,3 | 59,0 | 50,3 | - | 58,6 | 49,4 | - | 57,1 | 48,1 | - | - | |
| 40 | - | - | 44,5 | - | 49,6 | 42,8 | 55,5* | 48,6 | - | 56,7 | 47,8 | - | 55,2 | 46,4 | - | - | |
| 42 | - | - | 41,5 | - | 46,3 | 39,9 | - | 45,3 | 38,6 | 53,0 | 44,6 | - | 51,5 | 43,0 | - | - | |
| 43 | - | - | 40,2 | - | - | 38,6 | - | 43,9 | 37,3 | 51,4 | 43,2 | - | 50,0 | 41,6 | - | - | |
| 46 | - | - | - | - | - | 35,0 | - | 39,9 | 33,6 | 45,6* | 39,2 | 32,7 | 45,5 | 37,6 | - | - | |
| 48 | - | - | - | - | - | 33,0 | - | 37,7 | 31,6 | - | 37,0 | 30,6 | 43,0 | 35,4 | - | - | |
| 49 | - | - | - | - | - | 32,0 | - | - | 30,6 | - | 35,9 | 29,6 | 41,7 | 34,3 | 27,5 | - | |
| 50 | - | - | - | - | - | - | - | - | 29,6 | - | 34,8 | 28,6 | 40,5 | 33,2 | 26,6 | - | |
| 52 | - | - | - | - | - | - | - | - | 27,9 | - | 33,0 | 26,9 | 37,2* | 31,3 | 24,9 | - | |
| 54 | - | - | - | - | - | - | - | - | 26,3 | - | 31,2 | 25,3 | - | 29,4 | 23,2 | - | |
| 55 | - | - | - | - | - | - | - | - | 25,6 | - | - | 24,6 | - | 28,6 | 22,5 | - | |
| 58 | - | - | - | - | - | - | - | - | - | - | - | 22,5 | - | 26,2 | 20,4 | - | |
| 59 | - | - | - | - | - | - | - | - | - | - | - | 21,9 | - | 25,6 | 19,8 | - | |
| 61 | - | - | - | - | - | - | - | - | - | - | - | 20,8 | - | - | 18,6 | - | |
| 62 | - | - | - | - | - | - | - | - | - | - | - | - | - | - | 18,0 | - | |
| 66 | - | - | - | - | - | - | - | - | - | - | - | - | - | - | 16,1 | - | |

* Main boom angle 85° · Hauptauslegerwinkel 85° · Jarret de flèche principale 85° · Inclinazione braccio base 85° ·
 Ângulo de pluma principal 85° · Ângulo da lança principal 85° · Угол подъема гл. стрелы 85°

Main boom angle 87°, 85°, 75° and 65°, capacities for intermediate boom positions are calculated by the crane control system IC-1 ·
 Hauptauslegerwinkel 87°, 85°, 75° und 65°, Traglasten für Zwischenstellungen des Hauptauslegers werden von der Kransteuerung IC-1
 berechnet · Jarret de flèche principale 87°, 85°, 75° et 65°, le système de commande de la grue IC-1 calcule les charges pour les positions
 intermédiaires de la flèche · Inclinazione braccio base 87°, 85°, 75° e 65°, capacità per posizioni intermedie del braccio sono calcolate dal
 sistema di controllo della gru IC-1 · Ângulo de pluma principal 87°, 85°, 75° y 65°, las capacidades para posiciones de pluma intermedias
 son calculadas por el sistema de control de grúa IC-1 · Ângulos da lança principal 87°, 85°, 75° e 65°; as capacidades para posições da
 lança intermediária são calculadas pelo sistema de controle da grua IC-1 · Грузоподъемность при углах подъема главной стрелы
 87°, 85°, 75° и 65°, грузоподъемность в промежуточных положениях стрелы рассчитывается системой управления краном IC-1

| 205 t + 50 t | | 8,40 m | | 9.8 m/s | | 360° | | ISO | | | | | | | | | |
|--------------|-------|--------|------|---------|------|------|-------|------|---------|---|-------|------|------|---|-----|---|---|
| 42 m | | | | | | | | | | | | | | | | | |
| 54 m | | | 60 m | | | 66 m | | | 72 m | | | | | | | | |
| SW_1 | | | | | | | | | | | | | | | | | |
| 87°/85° | | | 75° | | | 65° | | | 87°/85° | | | 75° | | | 65° | | |
| m | t | t | t | t | t | t | t | t | t | t | t | t | t | t | t | t | t |
| 18 | 133,0 | - | - | - | - | - | - | - | - | - | - | - | - | - | - | - | - |
| 20 | 120,0 | - | - | 116,0 | - | - | - | - | - | - | - | - | - | - | - | - | - |
| 21 | 115,0 | - | - | 111,0 | - | - | 107,0 | - | - | - | - | - | - | - | - | - | - |
| 22 | 110,0 | - | - | 106,0 | - | - | 103,0 | - | - | - | 95,0 | - | - | - | - | - | - |
| 24 | 101,0 | - | - | 97,5 | - | - | 94,5 | - | - | - | 91,0 | - | - | - | - | - | - |
| 26 | 93,0 | - | - | 90,0 | - | - | 87,0 | - | - | - | 84,0 | - | - | - | - | - | - |
| 28 | 86,5 | - | - | 83,5 | - | - | 80,5 | - | - | - | 78,0 | - | - | - | - | - | - |
| 30 | 80,5 | - | - | 77,5 | - | - | 75,0 | - | - | - | 72,5 | - | - | - | - | - | - |
| 34 | 69,0 | - | - | 67,5 | - | - | 65,5 | - | - | - | 63,0 | - | - | - | - | - | - |
| 38 | 59,0 | 49,6 | - | 58,5 | - | - | 58,0 | - | - | - | 55,5 | - | - | - | - | - | - |
| 40 | 55,2 | 46,1 | - | 54,5 | 44,9 | - | 54,0 | - | - | - | 52,4 | - | - | - | - | - | - |
| 42 | 51,5 | 42,8 | - | 50,5 | 41,8 | - | 50,0 | - | - | - | 49,3 | - | - | - | - | - | - |
| 43 | 49,9 | 41,4 | - | 48,9 | 40,4 | - | 48,4 | 39,5 | - | - | 47,8 | - | - | - | - | - | - |
| 45 | 46,8 | 38,7 | - | 45,9 | 37,6 | - | 45,4 | 36,8 | - | - | 44,8 | 35,6 | - | - | - | - | - |
| 46 | 45,3 | 37,4 | - | 44,4 | 36,3 | - | 43,9 | 35,5 | - | - | 43,3 | 34,5 | - | - | - | - | - |
| 50 | 40,2 | 32,9 | - | 39,3 | 31,7 | - | 38,7 | 30,8 | - | - | 38,1 | 29,9 | - | - | - | - | - |
| 53 | 36,9 | 29,9 | 23,6 | 36,0 | 28,7 | - | 35,4 | 27,8 | - | - | 34,7 | 26,9 | - | - | - | - | - |
| 54 | 35,9 | 29,0 | 22,8 | 35,0 | 27,8 | - | 34,4 | 26,9 | - | - | 33,7 | 26,0 | - | - | - | - | - |
| 56 | 34,1 | 27,3 | 21,3 | 33,2 | 26,1 | 19,9 | 32,5 | 25,2 | - | - | 31,8 | 24,3 | - | - | - | - | - |
| 58 | 31,3* | 25,7 | 19,9 | 31,4 | 24,4 | 18,5 | 30,7 | 23,6 | - | - | 30,0 | 22,6 | - | - | - | - | - |
| 59 | - | 25,0 | 19,3 | 30,6 | 23,7 | 17,9 | 29,9 | 22,8 | 16,9 | - | 29,2 | 21,9 | - | - | - | - | - |
| 62 | - | 22,9 | 17,5 | 28,3 | 21,6 | 16,1 | 27,6 | 20,7 | 15,1 | - | 26,9 | 19,8 | - | - | - | - | - |
| 63 | - | 22,3 | 16,9 | 26,6* | 21,0 | 15,5 | 26,9 | 20,1 | 14,5 | - | 26,2 | 19,1 | 13,5 | - | - | - | - |
| 64 | - | 21,7 | 16,4 | 26,0* | 20,4 | 15,0 | 26,2 | 19,5 | 14,0 | - | 25,5 | 18,5 | 12,9 | - | - | - | - |
| 65 | - | 21,1 | 15,9 | - | 19,8 | 14,5 | 25,5 | 18,9 | 13,5 | - | 24,8 | 17,9 | 12,4 | - | - | - | - |
| 66 | - | - | 15,4 | - | 19,2 | 14,0 | 24,9 | 18,3 | 13,0 | - | 24,1 | 17,3 | 11,9 | - | - | - | - |
| 69 | - | - | 14,0 | - | 17,7 | 12,6 | 22,1* | 16,7 | 11,6 | - | 22,2 | 15,7 | 10,5 | - | - | - | - |
| 70 | - | - | 13,6 | - | 17,2 | 12,2 | - | 16,2 | 11,2 | - | 21,6 | 15,2 | 10,1 | - | - | - | - |
| 71 | - | - | 13,2 | - | 16,7 | 11,8 | - | 15,7 | 10,8 | - | 21,0 | 14,7 | 9,7 | - | - | - | - |
| 72 | - | - | 12,9 | - | - | 11,4 | - | 15,3 | 10,4 | - | 20,5 | 14,2 | 9,3 | - | - | - | - |
| 74 | - | - | - | - | - | 10,6 | - | 14,4 | 9,6 | - | 19,4 | 13,3 | 8,5 | - | - | - | - |
| 75 | - | - | - | - | - | 10,2 | - | 14,0 | 9,2 | - | 17,9* | 12,8 | 8,1 | - | - | - | - |
| 77 | - | - | - | - | - | 9,6 | - | 13,2 | 8,5 | - | - | 12,0 | 7,4 | - | - | - | - |
| 78 | - | - | - | - | - | 9,3 | - | - | 8,2 | - | - | 11,6 | 7,0 | - | - | - | - |
| 82 | - | - | - | - | - | - | - | - | 7,0 | - | - | 10,2 | 5,8 | - | - | - | - |
| 83 | - | - | - | - | - | - | - | - | 6,7 | - | - | 9,9 | 5,5 | - | - | - | - |
| 84 | - | - | - | - | - | - | - | - | 6,5 | - | - | - | 5,2 | - | - | - | - |
| 86 | - | - | - | - | - | - | - | - | - | - | - | - | 4,7 | - | - | - | - |
| 88 | - | - | - | - | - | - | - | - | - | - | - | - | 4,2 | - | - | - | - |

* Main boom angle 85° · Hauptauslegerwinkel 85° · Jarret de flèche principale 85° · Inclinazione braccio base 85° · Ángulo de pluma principal 85° · Ângulo da lança principal 85° · Угол подъема гл. стрелы 85°

Main boom angle 87°, 85°, 75° and 65°, capacities for intermediate boom positions are calculated by the crane control system IC-1 · Hauptauslegerwinkel 87°, 85°, 75° und 65°, Traglasten für Zwischenstellungen des Hauptauslegers werden von der Kransteuerung IC-1 berechnet · Jarret de flèche principale 87°, 85°, 75° et 65°, le système de commande de la grue IC-1 calcule les charges pour les positions intermédiaires de la flèche · Inclinazione braccio base 87°, 85°, 75° e 65°, capacità per posizioni intermedie del braccio sono calcolate dal sistema di controllo della gru IC-1 · Ángulo de pluma principal 87°, 85°, 75° y 65°, las capacidades para posiciones de pluma intermedias son calculadas por el sistema de control de grúa IC-1 · Ângulos da lança principal 87°, 85°, 75° e 65°, as capacidades para posições da lança intermediária são calculadas pelo sistema de controle da grua IC-1 · Грузоподъемность при углах подъема главной стрелы 87°, 85°, 75° и 65°, грузоподъемность в промежуточных положениях стрелы рассчитывается системой управления краном IC-1

| 205 t + 50 t | | 8,40 m | | 9.8 m/s | | 360° | | ISO | | | | | | | | | |
|--------------|-------|--------|------|---------|------|------|------|------|---------|---|------|------|---|---|-----|---|--|
| 42 m | | | | | | | | | | | | | | | | | |
| 78 m | | | 84 m | | | 90 m | | | 96 m | | | | | | | | |
| SW_1 | | | | | | | | | | | | | | | | | |
| 87°/85° | | | 75° | | | 65° | | | 87°/85° | | | 75° | | | 65° | | |
| m | t | t | t | t | t | t | t | t | t | t | t | t | t | t | t | t | |
| 24 | 80,5 | - | - | - | - | - | - | - | - | - | - | - | - | - | - | - | |
| 25 | 80,0 | - | - | 68,5 | - | - | - | - | - | - | - | - | - | - | - | - | |
| 26 | 79,5 | - | - | 68,0 | - | - | 58,5 | - | - | - | - | - | - | - | - | - | |
| 28 | 75,0 | - | - | 67,5 | - | - | 58,0 | - | - | - | 50,0 | - | - | - | - | - | |
| 30 | 70,0 | - | - | 66,5 | - | - | 57,0 | - | - | - | 49,7 | - | - | - | - | - | |
| 34 | 60,5 | - | - | 58,5 | - | - | 56,0 | - | - | - | 48,7 | - | - | - | - | - | |
| 38 | 53,5 | - | - | 51,0 | - | - | 49,3 | - | - | - | 47,1 | - | - | - | - | - | |
| 42 | 47,4 | - | - | 45,2 | - | - | 43,4 | - | - | - | 41,3 | - | - | - | - | - | |
| 46 | 42,2 | - | - | 40,1 | - | - | 38,5 | - | - | - | 36,4 | - | - | - | - | - | |
| 48 | 39,9 | 30,7 | - | 37,9 | - | - | 36,3 | - | - | - | 34,3 | - | - | - | - | - | |
| 50 | 37,4 | 28,9 | - | 35,8 | 26,7 | - | 34,2 | - | - | - | 32,2 | - | - | - | - | - | |
| 53 | 34,1 | 26,0 | - | 32,9 | 24,3 | - | 31,4 | 22,7 | - | - | 29,5 | - | - | - | - | - | |
| 54 | 33,1 | 25,1 | - | 32,0 | 23,5 | - | 30,5 | 21,9 | - | - | 28,6 | - | - | - | - | - | |
| 55 | 32,1 | 24,2 | - | 31,0 | 22,6 | - | 29,6 | 21,2 | - | - | 27,8 | 19,2 | - | - | - | - | |
| 58 | 29,4 | 21,7 | - | 28,3 | 20,2 | - | 27,2 | 19,2 | - | - | 25,4 | 17,2 | - | - | - | - | |
| 62 | 26,2 | 18,9 | - | 24,9 | 17,4 | - | 24,3 | 16,6 | - | - | 22,6 | 14,9 | - | - | - | - | |
| 66 | 23,3 | 16,4 | 10,9 | 22,0 | 14,9 | - | 21,3 | 14,2 | - | - | 20,1 | 12,8 | - | - | - | - | |
| 70 | 20,7 | 14,2 | 9,1 | 19,4 | 12,8 | 7,5 | 18,8 | 12,0 | - | - | 17,8 | 10,9 | - | - | - | - | |
| 73 | 19,0 | 12,7 | 7,9 | 17,7 | 11,3 | 6,3 | 17,0 | 10,5 | 5,4 | - | 16,1 | 9,5 | - | - | - | - | |
| 74 | 18,5 | 12,3 | 7,5 | 17,2 | 10,9 | 5,9 | 16,5 | 10,1 | 5,0 | - | 15,6 | 9,1 | - | - | - | - | |
| 76 | 17,5 | 11,5 | 6,7 | 16,1 | 10,0 | 5,2 | 15,5 | 9,2 | 4,3 | - | 14,5 | 8,2 | - | - | - | - | |
| 78 | 16,5 | 10,7 | 6,0 | 15,2 | 9,2 | 4,5 | 14,5 | 8,4 | - | - | 13,5 | 7,4 | - | - | - | - | |
| 79 | 16,0 | 10,3 | 5,7 | 14,7 | 8,8 | 4,1 | 14,0 | 8,0 | - | - | 13,0 | 7,0 | - | - | - | - | |
| 81 | 14,2* | 9,5 | 5,1 | 13,8 | 8,0 | - | 13,1 | 7,3 | - | - | 12,1 | 6,2 | - | - | - | - | |
| 82 | - | 9,2 | 4,8 | 13,4 | 7,7 | - | 12,7 | 6,9 | - | - | 11,7 | 5,8 | - | - | - | - | |
| 84 | - | 8,5 | 4,2 | 12,6 | 7,0 | - | 11,8 | 6,2 | - | - | 10,9 | 5,1 | - | - | - | - | |
| 86 | - | 7,9 | - | 10,9* | 6,4 | - | 11,0 | 5,6 | - | - | 10,1 | 4,5 | - | - | - | - | |
| 87 | - | 7,6 | - | 10,6* | 6,1 | - | 10,6 | 5,2 | - | - | 9,7 | 4,2 | - | - | - | - | |
| 88 | - | 7,3 | - | - | 5,8 | - | 10,3 | 4,9 | - | - | 9,3 | - | - | - | - | - | |
| 90 | - | - | - | - | 5,2 | - | 9,6 | 4,3 | - | - | 8,6 | - | - | - | - | - | |
| 91 | - | - | - | - | 4,9 | - | 9,3 | 4,1 | - | - | 8,2 | - | - | - | - | - | |
| 93 | - | - | - | - | 4,4 | - | 7,8* | - | - | - | 7,6 | - | - | - | - | - | |
| 94 | - | - | - | - | 4,2 | - | - | - | - | - | 7,3 | - | - | - | - | - | |
| 98 | - | - | - | - | - | - | - | - | - | - | 5,2* | - | - | - | - | - | |

* Main boom angle 85° · Hauptauslegerwinkel 85° · Jarret de flèche principale 85° · Inclinazione braccio base 85° ·
 Ángulo de pluma principal 85° · Ângulo da lança principal 85° · Угол подъема гл. стрелы 85°

Main boom angle 87°, 85°, 75° and 65°, capacities for intermediate boom positions are calculated by the crane control system IC-1 ·
 Hauptauslegerwinkel 87°, 85°, 75° und 65°, Traglasten für Zwischenstellungen des Hauptauslegers werden von der Kransteuerung IC-1
 berechnet · Jarret de flèche principale 87°, 85°, 75° et 65°, le système de commande de la grue IC-1 calcule les charges pour les positions
 intermédiaires de la flèche · Inclinazione braccio base 87°, 85°, 75° e 65°, capacità per posizioni intermedie del braccio sono calcolate dal
 sistema di controllo della gru IC-1 · Ángulo de pluma principal 87°, 85°, 75° y 65°, las capacidades para posiciones de pluma intermedias
 son calculadas por el sistema de control de grúa IC-1 · Ângulos da lança principal 87°, 85°, 75° e 65°, as capacidades para posições da
 lança intermediária são calculadas pelo sistema de controle da grua IC-1 · Грузоподъемность при углах подъема главной стрелы
 87°, 85°, 75° и 65°, грузоподъемность в промежуточных положениях стрелы рассчитывается системой управления краном IC-1

| 205 t + 50 t | | 8,40 m | | 9.8 m/s | | 360° | | ISO | | | | | | | | | |
|--------------|-------|--------|------|---------|------|------|-------|------|---------|-------|------|------|-------|------|------|---|--|
| 48 m | | | | | | | | | | | | | | | | | |
| 24 m | | | 30 m | | | 36 m | | | 42 m | | | 48 m | | | | | |
| SW_1 | | | | | | | | | | | | | | | | | |
| 87°/85° | | | 75° | | | 65° | | | 87°/85° | | | 75° | | | 65° | | |
| m | t | t | t | t | t | t | t | t | t | t | t | t | t | t | t | t | |
| 12 | 225,0 | - | - | - | - | - | - | - | - | - | - | - | - | - | - | - | |
| 13 | 209,0 | - | - | 200,0 | - | - | - | - | - | - | - | - | - | - | - | - | |
| 14 | 195,0 | - | - | 187,0 | - | - | 180,0 | - | - | - | - | - | - | - | - | - | |
| 16 | 172,0 | - | - | 166,0 | - | - | 159,0 | - | - | 154,0 | - | - | - | - | - | - | |
| 17 | 162,0 | - | - | 156,0 | - | - | 150,0 | - | - | 146,0 | - | - | 140,0 | - | - | - | |
| 18 | 154,0 | - | - | 148,0 | - | - | 143,0 | - | - | 138,0 | - | - | 132,0 | - | - | - | |
| 20 | 139,0 | - | - | 134,0 | - | - | 129,0 | - | - | 125,0 | - | - | 120,0 | - | - | - | |
| 22 | 127,0 | - | - | 122,0 | - | - | 118,0 | - | - | 114,0 | - | - | 110,0 | - | - | - | |
| 24 | 114,0 | - | - | 112,0 | - | - | 108,0 | - | - | 105,0 | - | - | 101,0 | - | - | - | |
| 26 | 102,0 | - | - | 101,0 | - | - | 100,0 | - | - | 97,0 | - | - | 93,0 | - | - | - | |
| 27 | 97,5 | 82,5 | - | 96,5 | - | - | 95,7 | - | - | 93,7 | - | - | 89,7 | - | - | - | |
| 28 | 93,0 | 78,5 | - | 92,0 | - | - | 91,5 | - | - | 90,5 | - | - | 86,5 | - | - | - | |
| 29 | 86,5* | 75,0 | - | 87,7 | 73,5 | - | 87,2 | - | - | 86,7 | - | - | 83,5 | - | - | - | |
| 30 | - | 71,5 | - | 83,5 | 70,0 | - | 83,0 | - | - | 83,0 | - | - | 80,5 | - | - | - | |
| 32 | - | 66,0 | - | 77,2 | 64,5 | - | 76,7 | 63,0 | - | 76,5 | - | - | 74,5 | - | - | - | |
| 34 | - | 60,5 | - | 71,0 | 59,0 | - | 70,5 | 58,0 | - | 70,0 | 57,5 | - | 68,5 | - | - | - | |
| 35 | - | 58,3 | - | 66,5* | 56,8 | - | 68,0 | 55,9 | - | 67,5 | 55,4 | - | 66,1 | - | - | - | |
| 37 | - | 54,1 | - | - | 52,6 | - | 63,0 | 51,8 | - | 62,5 | 51,2 | - | 61,3 | 49,5 | - | - | |
| 38 | - | 52,0 | 44,0 | - | 50,5 | - | 60,5 | 49,8 | - | 60,0 | 49,2 | - | 59,0 | 47,6 | - | - | |
| 41 | - | - | 39,5 | - | 45,7 | - | 53,0* | 44,8 | - | 54,3 | 44,1 | - | 53,0 | 42,6 | - | - | |
| 42 | - | - | 38,0 | - | 44,2 | 36,1 | - | 43,2 | - | 52,5 | 42,6 | - | 51,0 | 41,0 | - | - | |
| 44 | - | - | 35,7 | - | 41,6 | 33,7 | - | 40,6 | - | 49,4 | 39,9 | - | 48,0 | 38,3 | - | - | |
| 45 | - | - | 34,5 | - | - | 32,5 | - | 39,3 | 31,2 | 47,9 | 38,6 | - | 46,5 | 37,0 | - | - | |
| 46 | - | - | 33,4 | - | - | 31,4 | - | 38,0 | 30,1 | 44,9* | 37,3 | - | 45,1 | 35,7 | - | - | |
| 47 | - | - | - | - | - | 30,4 | - | 36,9 | 29,1 | 43,7* | 36,2 | - | 43,8 | 34,5 | - | - | |
| 49 | - | - | - | - | - | 28,6 | - | 34,8 | 27,2 | - | 34,0 | 26,3 | 41,3 | 32,3 | - | - | |
| 50 | - | - | - | - | - | 27,7 | - | - | 26,3 | - | 33,0 | 25,4 | 40,1 | 31,2 | - | - | |
| 51 | - | - | - | - | - | 26,9 | - | - | 25,5 | - | 32,1 | 24,6 | 39,0 | 30,2 | - | - | |
| 52 | - | - | - | - | - | - | - | - | 24,7 | - | 31,2 | 23,8 | 36,6* | 29,3 | 21,7 | - | |
| 53 | - | - | - | - | - | - | - | - | 23,9 | - | 30,3 | 23,0 | 35,6* | 28,4 | 20,9 | - | |
| 54 | - | - | - | - | - | - | - | - | 23,2 | - | 29,4 | 22,2 | - | 27,5 | 20,2 | - | |
| 55 | - | - | - | - | - | - | - | - | 22,5 | - | 28,7 | 21,5 | - | 26,7 | 19,5 | - | |
| 57 | - | - | - | - | - | - | - | - | 21,3 | - | - | 20,2 | - | 25,1 | 18,1 | - | |
| 58 | - | - | - | - | - | - | - | - | - | - | - | 19,6 | - | 24,4 | 17,5 | - | |
| 61 | - | - | - | - | - | - | - | - | - | - | - | 18,0 | - | 22,5 | 15,8 | - | |
| 62 | - | - | - | - | - | - | - | - | - | - | - | 17,5 | - | - | 15,3 | - | |
| 63 | - | - | - | - | - | - | - | - | - | - | - | 17,1 | - | - | 14,8 | - | |
| 66 | - | - | - | - | - | - | - | - | - | - | - | - | - | - | 13,5 | - | |
| 69 | - | - | - | - | - | - | - | - | - | - | - | - | - | - | 12,4 | - | |

* Main boom angle 85° · Hauptauslegerwinkel 85° · Jarret de flèche principale 85° · Inclinazione braccio base 85° · Ángulo de pluma principal 85° · Ângulo da lança principal 85° · Угол подъема гл. стрелы 85°

Main boom angle 87°, 85°, 75° and 65°, capacities for intermediate boom positions are calculated by the crane control system IC-1 · Hauptauslegerwinkel 87°, 85°, 75° und 65°, Traglasten für Zwischenstellungen des Hauptauslegers werden von der Kransteuerung IC-1 berechnet · Jarret de flèche principale 87°, 85°, 75° et 65°, le système de commande de la grue IC-1 calcule les charges pour les positions intermédiaires de la flèche · Inclinazione braccio base 87°, 85°, 75° e 65°, capacità per posizioni intermedie del braccio sono calcolate dal sistema di controllo della gru IC-1 · Ángulo de pluma principal 87°, 85°, 75° y 65°, las capacidades para posiciones de pluma intermedias son calculadas por el sistema de control de grúa IC-1 · Ângulos da lança principal 87°, 85°, 75° e 65°, as capacidades para posições da lança intermediária são calculadas pelo sistema de controle da grua IC-1 · Грузоподъемность при углах подъема главной стрелы 87°, 85°, 75° и 65°, грузоподъемность в промежуточных положениях стрелы рассчитывается системой управления краном IC-1

| 205 t + 50 t | | 8,40 m | | 9.8 m/s | | 360° | | ISO | | | | | | | | | |
|--------------|-------|--------|------|---------|------|------|-------|------|---------|---|-------|------|-----|---|-----|---|---|
| 48 m | | | | | | | | | | | | | | | | | |
| 54 m | | | 60 m | | | 66 m | | | 72 m | | | | | | | | |
| SW_1 | | | | | | | | | | | | | | | | | |
| 87°/85° | | | 75° | | | 65° | | | 87°/85° | | | 75° | | | 65° | | |
| m | t | t | t | t | t | t | t | t | t | t | t | t | t | t | t | t | t |
| 19 | 122,0 | - | - | - | - | - | - | - | - | - | - | - | - | - | - | - | - |
| 20 | 116,0 | - | - | 112,0 | - | - | - | - | - | - | - | - | - | - | - | - | - |
| 21 | 111,0 | - | - | 107,0 | - | - | 102,0 | - | - | - | - | - | - | - | - | - | - |
| 22 | 106,0 | - | - | 102,0 | - | - | 99,5 | - | - | - | - | - | - | - | - | - | - |
| 23 | 101,7 | - | - | 98,0 | - | - | 95,2 | - | - | - | 88,5 | - | - | - | - | - | - |
| 24 | 97,5 | - | - | 94,0 | - | - | 91,0 | - | - | - | 88,0 | - | - | - | - | - | - |
| 26 | 90,0 | - | - | 87,0 | - | - | 84,0 | - | - | - | 81,0 | - | - | - | - | - | - |
| 28 | 83,5 | - | - | 80,5 | - | - | 78,0 | - | - | - | 75,0 | - | - | - | - | - | - |
| 30 | 78,0 | - | - | 75,0 | - | - | 72,5 | - | - | - | 70,0 | - | - | - | - | - | - |
| 34 | 68,0 | - | - | 65,5 | - | - | 63,5 | - | - | - | 61,0 | - | - | - | - | - | - |
| 38 | 59,0 | - | - | 58,0 | - | - | 56,0 | - | - | - | 53,5 | - | - | - | - | - | - |
| 39 | 57,0 | 45,6 | - | 56,0 | - | - | 54,4 | - | - | - | 52,0 | - | - | - | - | - | - |
| 42 | 51,0 | 40,8 | - | 50,0 | 39,7 | - | 49,8 | - | - | - | 47,8 | - | - | - | - | - | - |
| 44 | 48,0 | 38,1 | - | 47,0 | 36,9 | - | 46,6 | 35,8 | - | - | 45,2 | - | - | - | - | - | - |
| 46 | 45,0 | 35,5 | - | 44,1 | 34,2 | - | 43,5 | 33,3 | - | - | 42,6 | - | - | - | - | - | - |
| 47 | 43,7 | 34,3 | - | 42,8 | 33,0 | - | 42,2 | 32,1 | - | - | 41,4 | 30,5 | - | - | - | - | - |
| 50 | 39,9 | 30,9 | - | 39,0 | 29,7 | - | 38,4 | 28,8 | - | - | 37,8 | 27,9 | - | - | - | - | - |
| 54 | 35,6 | 27,1 | - | 34,7 | 25,9 | - | 34,1 | 25,0 | - | - | 33,5 | 24,1 | - | - | - | - | - |
| 55 | 34,7 | 26,3 | 19,1 | 33,7 | 25,1 | - | 33,1 | 24,2 | - | - | 32,5 | 23,3 | - | - | - | - | - |
| 58 | 30,8* | 24,0 | 17,1 | 31,1 | 22,7 | - | 30,4 | 21,8 | - | - | 29,8 | 20,9 | - | - | - | - | - |
| 59 | - | 23,3 | 16,5 | 30,3 | 22,0 | 15,1 | 29,6 | 21,1 | - | - | 29,0 | 20,2 | - | - | - | - | - |
| 62 | - | 21,3 | 14,8 | 28,0 | 20,0 | 13,5 | 27,3 | 19,1 | 12,5 | - | 26,6 | 18,2 | - | - | - | - | - |
| 64 | - | 20,1 | 13,8 | 25,5* | 18,8 | 12,4 | 26,0 | 17,9 | 11,5 | - | 25,2 | 17,0 | - | - | - | - | - |
| 66 | - | 19,0 | 12,9 | - | 17,7 | 11,5 | 24,7 | 16,7 | 10,5 | - | 23,8 | 15,8 | 9,4 | - | - | - | - |
| 67 | - | 18,5 | 12,4 | - | 17,2 | 11,0 | 24,1 | 16,2 | 10,0 | - | 23,2 | 15,2 | 8,9 | - | - | - | - |
| 70 | - | - | 11,2 | - | 15,7 | 9,8 | 21,0* | 14,7 | 8,8 | - | 21,3 | 13,7 | 7,7 | - | - | - | - |
| 73 | - | - | 10,2 | - | 14,4 | 8,7 | - | 13,3 | 7,7 | - | 19,6 | 12,3 | 6,5 | - | - | - | - |
| 74 | - | - | 9,9 | - | - | 8,4 | - | 12,9 | 7,3 | - | 19,1 | 11,9 | 6,2 | - | - | - | - |
| 75 | - | - | 9,6 | - | - | 8,0 | - | 12,5 | 6,9 | - | 17,4* | 11,5 | 5,8 | - | - | - | - |
| 76 | - | - | - | - | - | 7,7 | - | 12,1 | 6,6 | - | 17,0* | 11,1 | 5,5 | - | - | - | - |
| 78 | - | - | - | - | - | 7,1 | - | 11,4 | 6,0 | - | - | 10,3 | 4,9 | - | - | - | - |
| 80 | - | - | - | - | - | 6,6 | - | - | 5,4 | - | - | 9,6 | 4,3 | - | - | - | - |
| 81 | - | - | - | - | - | - | - | - | 5,1 | - | - | 9,2 | 4,0 | - | - | - | - |
| 82 | - | - | - | - | - | - | - | - | 4,9 | - | - | 8,9 | - | - | - | - | - |
| 84 | - | - | - | - | - | - | - | - | 4,4 | - | - | 8,3 | - | - | - | - | - |
| 86 | - | - | - | - | - | - | - | - | 4,0 | - | - | - | - | - | - | - | - |

* Main boom angle 85° · Hauptauslegerwinkel 85° · Jarret de flèche principale 85° · Inclinazione braccio base 85° ·
 Ângulo de pluma principal 85° · Ângulo da lança principal 85° · Угол подъема гл. стрелы 85°

Main boom angle 87°, 85°, 75° and 65°, capacities for intermediate boom positions are calculated by the crane control system IC-1 ·
 Hauptauslegerwinkel 87°, 85°, 75° und 65°, Traglasten für Zwischenstellungen des Hauptauslegers werden von der Kransteuerung IC-1
 berechnet · Jarret de flèche principale 87°, 85°, 75° et 65°, le système de commande de la grue IC-1 calcule les charges pour les positions
 intermédiaires de la flèche · Inclinazione braccio base 87°, 85°, 75° e 65°, capacità per posizioni intermedie del braccio sono calcolate dal
 sistema di controllo della gru IC-1 · Ângulo de pluma principal 87°, 85°, 75° y 65°, las capacidades para posiciones de pluma intermedias
 son calculadas por el sistema de control de grúa IC-1 · Ângulos da lança principal 87°, 85°, 75° e 65°, as capacidades para posições da
 lança intermediária são calculadas pelo sistema de controle da grua IC-1 · Грузоподъемность при углах подъема главной стрелы
 87°, 85°, 75° и 65°, грузоподъемность в промежуточных положениях стрелы рассчитывается системой управления краном IC-1

| 205 t + 50 t | | 8,40 m | | 9.8 m/s | | 360° | | ISO | | | | | | | | | |
|--------------|-------|--------|------|---------|------|------|------|------|---------|------|------|-----|---|---|-----|--|--|
| 48 m | | | | | | | | | | | | | | | | | |
| 78 m | | | 84 m | | | 90 m | | | 96 m | | | | | | | | |
| SW_1 | | | | | | | | | | | | | | | | | |
| 87°/85° | | | 75° | | | 65° | | | 87°/85° | | | 75° | | | 65° | | |
| m | t | t | t | t | t | t | t | t | t | t | t | t | t | t | t | | |
| 24 | 75,5 | - | - | - | - | - | - | - | - | - | - | - | - | - | - | | |
| 25 | 75,2 | - | - | 64,5 | - | - | - | - | - | - | - | - | - | - | - | | |
| 26 | 75,0 | - | - | 64,0 | - | - | - | - | - | - | - | - | - | - | - | | |
| 27 | 73,7 | - | - | 63,7 | - | - | 55,0 | - | - | - | - | - | - | - | - | | |
| 28 | 72,5 | - | - | 63,5 | - | - | 54,5 | - | - | 47,3 | - | - | - | - | - | | |
| 30 | 67,5 | - | - | 63,0 | - | - | 54,0 | - | - | 46,9 | - | - | - | - | - | | |
| 34 | 58,5 | - | - | 56,0 | - | - | 53,0 | - | - | 46,0 | - | - | - | - | - | | |
| 38 | 51,5 | - | - | 49,5 | - | - | 47,6 | - | - | 45,0 | - | - | - | - | - | | |
| 42 | 45,9 | - | - | 43,7 | - | - | 41,9 | - | - | 39,8 | - | - | - | - | - | | |
| 46 | 40,8 | - | - | 38,8 | - | - | 37,1 | - | - | 35,0 | - | - | - | - | - | | |
| 50 | 36,5 | 26,1 | - | 34,5 | - | - | 32,9 | - | - | 31,0 | - | - | - | - | - | | |
| 52 | 34,6 | 24,5 | - | 32,7 | 22,4 | - | 31,1 | - | - | 29,1 | - | - | - | - | - | | |
| 54 | 32,8 | 23,0 | - | 30,9 | 21,0 | - | 29,3 | - | - | 27,4 | - | - | - | - | - | | |
| 55 | 31,8 | 22,2 | - | 30,1 | 20,3 | - | 28,5 | 18,7 | - | 26,6 | - | - | - | - | - | | |
| 57 | 30,0 | 20,8 | - | 28,5 | 19,0 | - | 26,9 | 17,4 | - | 25,0 | 15,4 | - | - | - | - | | |
| 58 | 29,1 | 20,0 | - | 27,7 | 18,4 | - | 26,2 | 16,8 | - | 24,3 | 14,8 | - | - | - | - | | |
| 62 | 26,0 | 17,3 | - | 24,7 | 15,7 | - | 23,4 | 14,5 | - | 21,6 | 12,6 | - | - | - | - | | |
| 66 | 23,0 | 14,9 | - | 21,7 | 13,4 | - | 20,9 | 12,5 | - | 19,2 | 10,6 | - | - | - | - | | |
| 69 | 21,1 | 13,3 | 7,1 | 19,8 | 11,8 | - | 19,1 | 11,0 | - | 17,5 | 9,3 | - | - | - | - | | |
| 70 | 20,5 | 12,8 | 6,7 | 19,2 | 11,3 | - | 18,5 | 10,5 | - | 17,0 | 8,9 | - | - | - | - | | |
| 74 | 18,2 | 11,0 | 5,2 | 16,9 | 9,5 | - | 16,2 | 8,7 | - | 15,0 | 7,3 | - | - | - | - | | |
| 77 | 16,7 | 9,8 | 4,2 | 15,4 | 8,3 | - | 14,7 | 7,5 | - | 13,6 | 6,1 | - | - | - | - | | |
| 78 | 16,3 | 9,4 | - | 14,9 | 7,9 | - | 14,2 | 7,1 | - | 13,2 | 5,8 | - | - | - | - | | |
| 82 | 13,4* | 7,9 | - | 13,2 | 6,4 | - | 12,4 | 5,7 | - | 11,5 | 4,5 | - | - | - | - | | |
| 83 | - | 7,6 | - | 12,8 | 6,1 | - | 12,0 | 5,3 | - | 11,1 | 4,2 | - | - | - | - | | |
| 86 | - | 6,7 | - | 11,6 | 5,2 | - | 10,8 | 4,4 | - | 9,9 | - | - | - | - | - | | |
| 87 | - | 6,4 | - | 10,2* | 4,9 | - | 10,4 | 4,1 | - | 9,5 | - | - | - | - | - | | |
| 90 | - | 5,6 | - | - | 4,0 | - | 9,4 | - | - | 8,4 | - | - | - | - | - | | |
| 93 | - | - | - | - | - | - | 7,4* | - | - | 7,4 | - | - | - | - | - | | |
| 94 | - | - | - | - | - | - | - | - | - | 7,1 | - | - | - | - | - | | |
| 98 | - | - | - | - | - | - | - | - | - | 4,9* | - | - | - | - | - | | |
| 99 | - | - | - | - | - | - | - | - | - | 4,6* | - | - | - | - | - | | |

* Main boom angle 85° · Hauptauslegerwinkel 85° · Jarret de flèche principale 85° · Inclinazione braccio base 85° ·
 Ângulo de pluma principal 85° · Ângulo da lança principal 85° · Угол подъема гл. стрелы 85°

Main boom angle 87°, 85°, 75° and 65°, capacities for intermediate boom positions are calculated by the crane control system IC-1 ·
 Hauptauslegerwinkel 87°, 85°, 75° und 65°, Traglasten für Zwischenstellungen des Hauptauslegers werden von der Kransteuerung IC-1
 berechnet · Jarret de flèche principale 87°, 85°, 75° et 65°, le système de commande de la grue IC-1 calcule les charges pour les positions
 intermédiaires de la flèche · Inclinazione braccio base 87°, 85°, 75° e 65°, capacità per posizioni intermedie del braccio sono calcolate dal
 sistema di controllo della gru IC-1 · Ângulo de pluma principal 87°, 85°, 75° y 65°, las capacidades para posiciones de pluma intermedias
 son calculadas por el sistema de control de grúa IC-1 · Ângulos da lança principal 87°, 85°, 75° e 65°, as capacidades para posições da
 lança intermediária são calculadas pelo sistema de controle da grua IC-1 · Грузоподъемность при углах подъема главной стрелы
 87°, 85°, 75° и 65°, грузоподъемность в промежуточных положениях стрелы рассчитывается системой управления краном IC-1

| 205 t + 50 t | | 8,40 m | | 9.8 m/s | | 360° | | ISO | | | | | | | | | |
|--------------|-------|--------|------|---------|------|------|-------|------|---------|-------|------|------|-------|------|------|---|--|
| 54 m | | | | | | | | | | | | | | | | | |
| 24 m | | | 30 m | | | 36 m | | | 42 m | | | 48 m | | | | | |
| SW_1 | | | | | | | | | | | | | | | | | |
| 87°/85° | | | 75° | | | 65° | | | 87°/85° | | | 75° | | | 65° | | |
| m | t | t | t | t | t | t | t | t | t | t | t | t | t | t | t | t | |
| 12 | 214,0 | - | - | - | - | - | - | - | - | - | - | - | - | - | - | - | |
| 14 | 187,0 | - | - | 179,0 | - | - | - | - | - | - | - | - | - | - | - | - | |
| 15 | 175,0 | - | - | 169,0 | - | - | 162,0 | - | - | - | - | - | - | - | - | - | |
| 16 | 165,0 | - | - | 159,0 | - | - | 153,0 | - | - | 148,0 | - | - | - | - | - | - | |
| 17 | 156,0 | - | - | 150,0 | - | - | 145,0 | - | - | 140,0 | - | - | 134,0 | - | - | - | |
| 18 | 148,0 | - | - | 143,0 | - | - | 137,0 | - | - | 133,0 | - | - | 127,0 | - | - | - | |
| 20 | 134,0 | - | - | 129,0 | - | - | 125,0 | - | - | 121,0 | - | - | 116,0 | - | - | - | |
| 22 | 123,0 | - | - | 118,0 | - | - | 114,0 | - | - | 110,0 | - | - | 106,0 | - | - | - | |
| 24 | 113,0 | - | - | 109,0 | - | - | 105,0 | - | - | 101,0 | - | - | 97,5 | - | - | - | |
| 26 | 102,0 | - | - | 101,0 | - | - | 97,0 | - | - | 94,0 | - | - | 90,0 | - | - | - | |
| 28 | 92,5 | - | - | 91,0 | - | - | 90,0 | - | - | 87,5 | - | - | 83,5 | - | - | - | |
| 29 | 85,5* | 72,0 | - | 87,0 | - | - | 86,2 | - | - | 84,5 | - | - | 80,7 | - | - | - | |
| 30 | 81,5* | 68,5 | - | 83,0 | - | - | 82,5 | - | - | 81,5 | - | - | 78,0 | - | - | - | |
| 31 | - | 65,8 | - | 79,8 | 64,0 | - | 79,2 | - | - | 78,5 | - | - | 75,5 | - | - | - | |
| 34 | - | 58,0 | - | 70,5 | 56,5 | - | 69,5 | 55,5 | - | 69,5 | - | - | 68,0 | - | - | - | |
| 36 | - | 53,9 | - | 63,0* | 52,4 | - | 64,7 | 51,3 | - | 64,5 | 50,5 | - | 63,2 | - | - | - | |
| 38 | - | 49,9 | - | - | 48,4 | - | 60,0 | 47,5 | - | 59,5 | 46,9 | - | 58,5 | - | - | - | |
| 39 | - | 48,2 | - | - | 46,6 | - | 58,0 | 45,9 | - | 57,6 | 45,3 | - | 56,5 | 43,5 | - | - | |
| 41 | - | - | 35,4 | - | 43,5 | - | 52,3* | 42,7 | - | 53,8 | 42,1 | - | 52,5 | 40,3 | - | - | |
| 42 | - | - | 34,2 | - | 42,0 | - | 50,5* | 41,1 | - | 52,0 | 40,5 | - | 50,5 | 38,7 | - | - | |
| 45 | - | - | 30,9 | - | 38,2 | 28,8 | - | 37,2 | - | 47,4 | 36,6 | - | 46,1 | 34,7 | - | - | |
| 46 | - | - | 29,8 | - | - | 27,8 | - | 36,0 | - | 44,2* | 35,3 | - | 44,7 | 33,4 | - | - | |
| 47 | - | - | 28,8 | - | - | 26,9 | - | 34,9 | - | 42,9* | 34,2 | - | 43,4 | 32,3 | - | - | |
| 48 | - | - | 27,9 | - | - | 26,0 | - | 33,9 | 24,7 | - | 33,1 | - | 42,2 | 31,2 | - | - | |
| 50 | - | - | - | - | - | 24,2 | - | 31,8 | 23,0 | - | 30,9 | - | 39,7 | 29,1 | - | - | |
| 51 | - | - | - | - | - | 23,5 | - | 30,9 | 22,2 | - | 30,0 | 21,3 | 38,6 | 28,2 | - | - | |
| 53 | - | - | - | - | - | 22,1 | - | - | 20,7 | - | 28,2 | 19,8 | 34,9* | 26,4 | - | - | |
| 54 | - | - | - | - | - | 21,5 | - | - | 20,0 | - | 27,4 | 19,1 | - | 25,5 | - | - | |
| 55 | - | - | - | - | - | - | - | - | 19,4 | - | 26,6 | 18,5 | - | 24,7 | 16,4 | - | |
| 57 | - | - | - | - | - | - | - | - | 18,2 | - | 25,2 | 17,3 | - | 23,2 | 15,2 | - | |
| 58 | - | - | - | - | - | - | - | - | 17,7 | - | - | 16,7 | - | 22,5 | 14,6 | - | |
| 60 | - | - | - | - | - | - | - | - | 16,7 | - | - | 15,7 | - | 21,3 | 13,5 | - | |
| 62 | - | - | - | - | - | - | - | - | - | - | - | 14,7 | - | 20,1 | 12,5 | - | |
| 66 | - | - | - | - | - | - | - | - | - | - | - | 13,1 | - | - | 10,8 | - | |
| 70 | - | - | - | - | - | - | - | - | - | - | - | - | - | - | 9,4 | - | |
| 71 | - | - | - | - | - | - | - | - | - | - | - | - | - | - | 9,1 | - | |

* Main boom angle 85° · Hauptauslegerwinkel 85° · Jarret de flèche principale 85° · Inclinazione braccio base 85° ·
 Ângulo de pluma principal 85° · Ângulo da lança principal 85° · Угол подъема гл. стрелы 85°

Main boom angle 87°, 85°, 75° and 65°, capacities for intermediate boom positions are calculated by the crane control system IC-1 ·
 Hauptauslegerwinkel 87°, 85°, 75° und 65°, Traglasten für Zwischenstellungen des Hauptauslegers werden von der Kransteuerung IC-1
 berechnet · Jarret de flèche principale 87°, 85°, 75° et 65°, le système de commande de la grue IC-1 calcule les charges pour les positions
 intermédiaires de la flèche · Inclinazione braccio base 87°, 85°, 75° e 65°, capacità per posizioni intermedie del braccio sono calcolate dal
 sistema di controllo della gru IC-1 · Ângulo de pluma principal 87°, 85°, 75° y 65°, las capacidades para posiciones de pluma intermedias
 son calculadas por el sistema de control de grúa IC-1 · Ângulos da lança principal 87°, 85°, 75° e 65°, as capacidades para posições da
 lança intermediária são calculadas pelo sistema de controle da grua IC-1 · Грузоподъемность при углах подъема главной стрелы
 87°, 85°, 75° и 65°, грузоподъемность в промежуточных положениях стрелы рассчитывается системой управления краном IC-1

| 205 t + 50 t | | 8,40 m | | 9.8 m/s | | 360° | | ISO | | | | | | | | | |
|--------------|-------|--------|------|---------|------|------|-------|------|---------|---|-------|------|-----|---|-----|---|---|
| 54 m | | | | | | | | | | | | | | | | | |
| 54 m | | | 60 m | | | 66 m | | | 72 m | | | | | | | | |
| SW_1 | | | | | | | | | | | | | | | | | |
| 87°/85° | | | 75° | | | 65° | | | 87°/85° | | | 75° | | | 65° | | |
| m | t | t | t | t | t | t | t | t | t | t | t | t | t | t | t | t | t |
| 19 | 117,0 | - | - | - | - | - | - | - | - | - | - | - | - | - | - | - | - |
| 20 | 112,0 | - | - | 108,0 | - | - | - | - | - | - | - | - | - | - | - | - | - |
| 22 | 102,0 | - | - | 99,0 | - | - | 94,5 | - | - | - | - | - | - | - | - | - | - |
| 23 | 98,2 | - | - | 95,0 | - | - | 91,2 | - | - | - | 82,5 | - | - | - | - | - | - |
| 24 | 94,5 | - | - | 91,0 | - | - | 88,0 | - | - | - | 81,5 | - | - | - | - | - | - |
| 26 | 87,0 | - | - | 84,0 | - | - | 81,5 | - | - | - | 78,0 | - | - | - | - | - | - |
| 28 | 81,0 | - | - | 78,0 | - | - | 75,5 | - | - | - | 72,5 | - | - | - | - | - | - |
| 30 | 75,5 | - | - | 72,5 | - | - | 70,0 | - | - | - | 67,5 | - | - | - | - | - | - |
| 34 | 66,0 | - | - | 63,5 | - | - | 61,5 | - | - | - | 59,0 | - | - | - | - | - | - |
| 38 | 58,5 | - | - | 56,0 | - | - | 54,0 | - | - | - | 52,0 | - | - | - | - | - | - |
| 41 | 52,5 | 40,1 | - | 51,5 | - | - | 49,8 | - | - | - | 47,6 | - | - | - | - | - | - |
| 42 | 50,5 | 38,6 | - | 50,0 | - | - | 48,4 | - | - | - | 46,2 | - | - | - | - | - | - |
| 44 | 47,5 | 35,9 | - | 46,8 | 34,5 | - | 45,8 | - | - | - | 43,7 | - | - | - | - | - | - |
| 46 | 44,6 | 33,2 | - | 43,7 | 32,0 | - | 43,2 | 30,8 | - | - | 41,2 | - | - | - | - | - | - |
| 49 | 40,7 | 29,9 | - | 39,8 | 28,7 | - | 39,3 | 27,7 | - | - | 38,0 | 25,9 | - | - | - | - | - |
| 50 | 39,5 | 28,9 | - | 38,6 | 27,6 | - | 38,0 | 26,7 | - | - | 37,0 | 25,1 | - | - | - | - | - |
| 54 | 35,3 | 25,2 | - | 34,3 | 24,0 | - | 33,7 | 23,1 | - | - | 33,2 | 22,2 | - | - | - | - | - |
| 58 | 30,2* | 22,2 | 14,2 | 30,7 | 20,9 | - | 30,1 | 20,0 | - | - | 29,5 | 19,1 | - | - | - | - | - |
| 59 | 29,5* | 21,5 | 13,6 | 29,9 | 20,2 | - | 29,3 | 19,3 | - | - | 28,7 | 18,4 | - | - | - | - | - |
| 62 | - | 19,6 | 12,1 | 27,7 | 18,3 | 10,7 | 27,0 | 17,4 | - | - | 26,4 | 16,5 | - | - | - | - | - |
| 65 | - | 17,9 | 10,7 | 24,3* | 16,5 | 9,3 | 25,0 | 15,6 | 8,3 | - | 24,2 | 14,7 | - | - | - | - | - |
| 66 | - | 17,4 | 10,3 | - | 16,0 | 8,9 | 24,4 | 15,1 | 7,9 | - | 23,5 | 14,2 | - | - | - | - | - |
| 68 | - | 16,4 | 9,5 | - | 15,0 | 8,1 | 23,1 | 14,1 | 7,1 | - | 22,2 | 13,2 | 6,0 | - | - | - | - |
| 70 | - | - | 8,8 | - | 14,1 | 7,4 | 20,5* | 13,2 | 6,4 | - | 21,0 | 12,2 | 5,3 | - | - | - | - |
| 71 | - | - | 8,4 | - | 13,7 | 7,0 | 19,9* | 12,7 | 6,0 | - | 20,4 | 11,8 | 4,9 | - | - | - | - |
| 73 | - | - | 7,8 | - | 12,9 | 6,3 | - | 11,9 | 5,3 | - | 19,3 | 10,9 | 4,2 | - | - | - | - |
| 74 | - | - | 7,5 | - | 12,5 | 6,0 | - | 11,5 | 5,0 | - | 18,8 | 10,5 | - | - | - | - | - |
| 76 | - | - | 6,9 | - | - | 5,4 | - | 10,7 | 4,4 | - | 16,5* | 9,7 | - | - | - | - | - |
| 77 | - | - | 6,7 | - | - | 5,1 | - | 10,3 | 4,1 | - | - | 9,3 | - | - | - | - | - |
| 78 | - | - | - | - | - | 4,9 | - | 10,0 | - | - | - | 8,9 | - | - | - | - | - |
| 80 | - | - | - | - | - | 4,3 | - | 9,4 | - | - | - | 8,2 | - | - | - | - | - |
| 81 | - | - | - | - | - | 4,1 | - | - | - | - | - | 7,9 | - | - | - | - | - |
| 82 | - | - | - | - | - | - | - | - | - | - | - | 7,6 | - | - | - | - | - |
| 86 | - | - | - | - | - | - | - | - | - | - | - | 6,5 | - | - | - | - | - |

* Main boom angle 85° · Hauptauslegerwinkel 85° · Jarret de flèche principale 85° · Inclinazione braccio base 85° ·
 Ângulo de pluma principal 85° · Ângulo da lança principal 85° · Угол подъема гл. стрелы 85°

Main boom angle 87°, 85°, 75° and 65°, capacities for intermediate boom positions are calculated by the crane control system IC-1 ·
 Hauptauslegerwinkel 87°, 85°, 75° und 65°, Traglasten für Zwischenstellungen des Hauptauslegers werden von der Kransteuerung IC-1
 berechnet · Jarret de flèche principale 87°, 85°, 75° et 65°, le système de commande de la grue IC-1 calcule les charges pour les positions
 intermédiaires de la flèche · Inclinazione braccio base 87°, 85°, 75° e 65°, capacità per posizioni intermedie del braccio sono calcolate dal
 sistema di controllo della gru IC-1 · Ângulo de pluma principal 87°, 85°, 75° y 65°, las capacidades para posiciones de pluma intermedias
 son calculadas por el sistema de control de grúa IC-1 · Ângulos da lança principal 87°, 85°, 75° e 65°, as capacidades para posições da
 lança intermediária são calculadas pelo sistema de controle da grua IC-1 · Грузоподъемность при углах подъема главной стрелы
 87°, 85°, 75° и 65°, грузоподъемность в промежуточных положениях стрелы рассчитывается системой управления краном IC-1

| 205 t + 50 t | | 8,40 m | | 9.8 m/s | | 360° | | ISO | | | | | | | | | |
|--------------|-------|--------|------|---------|------|------|------|------|---------|------|------|-----|---|---|-----|--|--|
| 54 m | | | | | | | | | | | | | | | | | |
| 78 m | | | 84 m | | | 90 m | | | 96 m | | | | | | | | |
| SW_1 | | | | | | | | | | | | | | | | | |
| 87°/85° | | | 75° | | | 65° | | | 87°/85° | | | 75° | | | 65° | | |
| m | t | t | t | t | t | t | t | t | t | t | t | t | t | t | t | | |
| 24 | 69,5 | - | - | - | - | - | - | - | - | - | - | - | - | - | - | | |
| 26 | 69,0 | - | - | 60,0 | - | - | - | - | - | - | - | - | - | - | - | | |
| 27 | 68,5 | - | - | 59,7 | - | - | 51,5 | - | - | - | - | - | - | - | - | | |
| 28 | 68,0 | - | - | 59,5 | - | - | 51,0 | - | - | 44,3 | - | - | - | - | - | | |
| 30 | 65,0 | - | - | 59,0 | - | - | 50,5 | - | - | 43,9 | - | - | - | - | - | | |
| 34 | 56,5 | - | - | 54,0 | - | - | 49,9 | - | - | 43,1 | - | - | - | - | - | | |
| 38 | 50,0 | - | - | 47,7 | - | - | 45,8 | - | - | 42,2 | - | - | - | - | - | | |
| 42 | 44,3 | - | - | 42,1 | - | - | 40,3 | - | - | 38,2 | - | - | - | - | - | | |
| 46 | 39,4 | - | - | 37,3 | - | - | 35,7 | - | - | 33,6 | - | - | - | - | - | | |
| 50 | 35,3 | - | - | 33,2 | - | - | 31,6 | - | - | 29,7 | - | - | - | - | - | | |
| 51 | 34,4 | 22,6 | - | 32,3 | - | - | 30,7 | - | - | 28,8 | - | - | - | - | - | | |
| 54 | 31,7 | 20,5 | - | 29,7 | 18,4 | - | 28,1 | - | - | 26,3 | - | - | - | - | - | | |
| 56 | 30,1 | 19,2 | - | 28,1 | 17,1 | - | 26,6 | 15,5 | - | 24,8 | - | - | - | - | - | | |
| 58 | 28,5 | 18,0 | - | 26,6 | 15,9 | - | 25,1 | 14,4 | - | 23,3 | - | - | - | - | - | | |
| 59 | 27,8 | 17,4 | - | 25,9 | 15,3 | - | 24,4 | 13,8 | - | 22,6 | 11,8 | - | - | - | - | | |
| 62 | 25,6 | 15,6 | - | 23,9 | 13,8 | - | 22,4 | 12,2 | - | 20,6 | 10,3 | - | - | - | - | | |
| 66 | 22,7 | 13,3 | - | 21,4 | 11,8 | - | 20,0 | 10,4 | - | 18,2 | 8,5 | - | - | - | - | | |
| 70 | 20,2 | 11,3 | - | 18,9 | 9,8 | - | 17,8 | 8,7 | - | 16,1 | 6,8 | - | - | - | - | | |
| 74 | 18,0 | 9,6 | - | 16,6 | 8,0 | - | 15,9 | 7,2 | - | 14,2 | 5,3 | - | - | - | - | | |
| 77 | 16,5 | 8,4 | - | 15,1 | 6,8 | - | 14,4 | 6,0 | - | 12,8 | 4,3 | - | - | - | - | | |
| 78 | 16,0 | 8,0 | - | 14,7 | 6,5 | - | 14,0 | 5,7 | - | 12,4 | - | - | - | - | - | | |
| 82 | 13,0* | 6,6 | - | 12,9 | 5,1 | - | 12,2 | 4,3 | - | 10,9 | - | - | - | - | - | | |
| 83 | - | 6,3 | - | 12,5 | 4,8 | - | 11,8 | 4,0 | - | 10,5 | - | - | - | - | - | | |
| 85 | - | 5,7 | - | 11,7 | 4,2 | - | 11,0 | - | - | 9,7 | - | - | - | - | - | | |
| 86 | - | 5,4 | - | 11,4 | - | - | 10,6 | - | - | 9,4 | - | - | - | - | - | | |
| 88 | - | 4,9 | - | 9,4* | - | - | 9,9 | - | - | 8,8 | - | - | - | - | - | | |
| 90 | - | 4,4 | - | - | - | - | 9,2 | - | - | 8,2 | - | - | - | - | - | | |
| 91 | - | 4,1 | - | - | - | - | 8,8 | - | - | 7,8 | - | - | - | - | - | | |
| 94 | - | - | - | - | - | - | 6,7* | - | - | 6,9 | - | - | - | - | - | | |
| 98 | - | - | - | - | - | - | - | - | - | 5,7 | - | - | - | - | - | | |
| 99 | - | - | - | - | - | - | - | - | - | 4,3* | - | - | - | - | - | | |

* Main boom angle 85° · Hauptauslegerwinkel 85° · Jarret de flèche principale 85° · Inclinazione braccio base 85° ·
 Ángulo de pluma principal 85° · Ángulo da lança principal 85° · Угол подъема гл. стрелы 85°

Main boom angle 87°, 85°, 75° and 65°, capacities for intermediate boom positions are calculated by the crane control system IC-1 ·
 Hauptauslegerwinkel 87°, 85°, 75° und 65°, Traglasten für Zwischenstellungen des Hauptauslegers werden von der Kransteuerung IC-1
 berechnet · Jarret de flèche principale 87°, 85°, 75° et 65°, le système de commande de la grue IC-1 calcule les charges pour les positions
 intermédiaires de la flèche · Inclinazione braccio base 87°, 85°, 75° e 65°, capacità per posizioni intermedie del braccio sono calcolate dal
 sistema di controllo della gru IC-1 · Ángulo de pluma principal 87°, 85°, 75° y 65°, las capacidades para posiciones de pluma intermedias
 son calculadas por el sistema de control de grúa IC-1 · Ángulos da lança principal 87°, 85°, 75° e 65°, as capacidades para posições da
 lança intermediária são calculadas pelo sistema de controle da grua IC-1 · Грузоподъемность при углах подъема главной стрелы
 87°, 85°, 75° и 65°, грузоподъемность в промежуточных положениях стрелы рассчитывается системой управления краном IC-1

| 205 t + 50 t | | 8,40 m | | 9.8 m/s | | 360° | | ISO | | | | | | | | | |
|--------------|-------|--------|------|---------|------|------|-------|------|---------|-------|------|------|-------|------|------|---|--|
| 60 m | | | | | | | | | | | | | | | | | |
| 24 m | | | 30 m | | | 36 m | | | 42 m | | | 48 m | | | | | |
| SW_1 | | | | | | | | | | | | | | | | | |
| 87°/85° | | | 75° | | | 65° | | | 87°/85° | | | 75° | | | 65° | | |
| m | t | t | t | t | t | t | t | t | t | t | t | t | t | t | t | t | |
| 13 | 190,0 | - | - | - | - | - | - | - | - | - | - | - | - | - | - | - | |
| 14 | 178,0 | - | - | 171,0 | - | - | - | - | - | - | - | - | - | - | - | - | |
| 15 | 168,0 | - | - | 161,0 | - | - | 155,0 | - | - | - | - | - | - | - | - | - | |
| 16 | 158,0 | - | - | 153,0 | - | - | 147,0 | - | - | - | - | - | - | - | - | - | |
| 17 | 150,0 | - | - | 144,0 | - | - | 139,0 | - | - | 134,0 | - | - | - | - | - | - | |
| 18 | 142,0 | - | - | 137,0 | - | - | 132,0 | - | - | 128,0 | - | - | 122,0 | - | - | - | |
| 20 | 129,0 | - | - | 125,0 | - | - | 120,0 | - | - | 116,0 | - | - | 111,0 | - | - | - | |
| 22 | 118,0 | - | - | 114,0 | - | - | 110,0 | - | - | 106,0 | - | - | 102,0 | - | - | - | |
| 24 | 109,0 | - | - | 105,0 | - | - | 101,0 | - | - | 98,0 | - | - | 94,0 | - | - | - | |
| 26 | 101,0 | - | - | 97,5 | - | - | 93,5 | - | - | 91,0 | - | - | 87,0 | - | - | - | |
| 28 | 91,5 | - | - | 90,5 | - | - | 87,0 | - | - | 84,5 | - | - | 81,0 | - | - | - | |
| 30 | 80,5* | 65,5 | - | 82,5 | - | - | 81,5 | - | - | 79,0 | - | - | 75,5 | - | - | - | |
| 33 | - | 57,6 | - | 72,7 | 56,0 | - | 72,1 | - | - | 71,1 | - | - | 68,3 | - | - | - | |
| 34 | - | 55,0 | - | 69,5 | 53,5 | - | 69,0 | - | - | 68,5 | - | - | 66,0 | - | - | - | |
| 35 | - | 53,0 | - | 64,5* | 51,5 | - | 66,6 | 50,5 | - | 66,1 | - | - | 64,0 | - | - | - | |
| 36 | - | 51,0 | - | 62,0* | 49,6 | - | 64,2 | 48,6 | - | 63,7 | - | - | 62,0 | - | - | - | |
| 38 | - | 47,4 | - | - | 45,8 | - | 59,5 | 45,0 | - | 59,0 | 44,3 | - | 58,0 | - | - | - | |
| 41 | - | 42,7 | - | - | 41,1 | - | 51,6* | 40,2 | - | 53,3 | 39,5 | - | 52,0 | 37,5 | - | - | |
| 42 | - | - | - | - | 39,6 | - | 49,8* | 38,6 | - | 51,5 | 37,9 | - | 50,0 | 36,0 | - | - | |
| 44 | - | - | 27,7 | - | 37,1 | - | - | 36,0 | - | 48,5 | 35,3 | - | 47,1 | 33,3 | - | - | |
| 46 | - | - | 25,8 | - | 34,6 | - | - | 33,5 | - | 45,6 | 32,8 | - | 44,2 | 30,9 | - | - | |
| 47 | - | - | 25,0 | - | 33,6 | 22,9 | - | 32,4 | - | 42,2* | 31,7 | - | 42,9 | 29,8 | - | - | |
| 48 | - | - | 24,2 | - | - | 22,1 | - | 31,4 | - | 41,0* | 30,6 | - | 41,7 | 28,8 | - | - | |
| 50 | - | - | 22,6 | - | - | 20,5 | - | 29,4 | - | - | 28,6 | - | 39,2 | 26,8 | - | - | |
| 51 | - | - | 21,9 | - | - | 19,8 | - | 28,5 | 18,6 | - | 27,7 | - | 38,1 | 25,9 | - | - | |
| 52 | - | - | - | - | - | 19,2 | - | 27,7 | 17,9 | - | 26,9 | - | 37,1 | 25,0 | - | - | |
| 54 | - | - | - | - | - | 17,9 | - | - | 16,6 | - | 25,2 | 15,7 | 33,3* | 23,3 | - | - | |
| 57 | - | - | - | - | - | 16,4 | - | - | 14,9 | - | 23,1 | 14,0 | - | 21,2 | - | - | |
| 58 | - | - | - | - | - | - | - | - | 14,4 | - | 22,5 | 13,5 | - | 20,5 | 11,4 | - | |
| 62 | - | - | - | - | - | - | - | - | 12,7 | - | - | 11,6 | - | 18,1 | 9,5 | - | |
| 64 | - | - | - | - | - | - | - | - | - | - | - | 10,8 | - | 17,1 | 8,7 | - | |
| 66 | - | - | - | - | - | - | - | - | - | - | - | 10,1 | - | - | 7,9 | - | |
| 68 | - | - | - | - | - | - | - | - | - | - | - | 9,5 | - | - | 7,2 | - | |
| 70 | - | - | - | - | - | - | - | - | - | - | - | - | - | - | 6,6 | - | |
| 74 | - | - | - | - | - | - | - | - | - | - | - | - | - | - | 5,6 | - | |

* Main boom angle 85° · Hauptauslegerwinkel 85° · Jarret de flèche principale 85° · Inclinazione braccio base 85° ·
 Ángulo de pluma principal 85° · Ângulo da lança principal 85° · Угол подъема гл. стрелы 85°

Main boom angle 87°, 85°, 75° and 65°, capacities for intermediate boom positions are calculated by the crane control system IC-1 ·
 Hauptauslegerwinkel 87°, 85°, 75° und 65°, Traglasten für Zwischenstellungen des Hauptauslegers werden von der Kransteuerung IC-1
 berechnet · Jarret de flèche principale 87°, 85°, 75° et 65°, le système de commande de la grue IC-1 calcule les charges pour les positions
 intermédiaires de la flèche · Inclinazione braccio base 87°, 85°, 75° e 65°, capacità per posizioni intermedie del braccio sono calcolate dal
 sistema di controllo della gru IC-1 · Ángulo de pluma principal 87°, 85°, 75° y 65°, las capacidades para posiciones de pluma intermedias
 son calculadas por el sistema de control de grúa IC-1 · Ângulos da lança principal 87°, 85°, 75° e 65°, as capacidades para posições da
 lança intermediária são calculadas pelo sistema de controle da grua IC-1 · Грузоподъемность при углах подъема главной стрелы
 87°, 85°, 75° и 65°, грузоподъемность в промежуточных положениях стрелы рассчитывается системой управления краном IC-1

| 205 t + 50 t | | 8,40 m | | 9.8 m/s | | 360° | | ISO | | | | | | | | | |
|--------------|-------|--------|------|---------|------|------|-------|------|---------|---|-------|------|---|---|-----|---|---|
| 60 m | | | | | | | | | | | | | | | | | |
| 54 m | | | 60 m | | | 66 m | | | 72 m | | | | | | | | |
| SW_1 | | | | | | | | | | | | | | | | | |
| 87°/85° | | | 75° | | | 65° | | | 87°/85° | | | 75° | | | 65° | | |
| m | t | t | t | t | t | t | t | t | t | t | t | t | t | t | t | t | t |
| 19 | 113,0 | - | - | - | - | - | - | - | - | - | - | - | - | - | - | - | - |
| 20 | 108,0 | - | - | 101,0 | - | - | - | - | - | - | - | - | - | - | - | - | - |
| 22 | 98,5 | - | - | 95,0 | - | - | 87,5 | - | - | - | - | - | - | - | - | - | - |
| 23 | 94,7 | - | - | 91,2 | - | - | 86,0 | - | - | - | 76,5 | - | - | - | - | - | - |
| 24 | 91,0 | - | - | 87,5 | - | - | 84,5 | - | - | - | 76,0 | - | - | - | - | - | - |
| 26 | 84,0 | - | - | 81,0 | - | - | 78,5 | - | - | - | 75,0 | - | - | - | - | - | - |
| 28 | 78,0 | - | - | 75,0 | - | - | 72,5 | - | - | - | 70,0 | - | - | - | - | - | - |
| 30 | 73,0 | - | - | 70,0 | - | - | 67,5 | - | - | - | 65,0 | - | - | - | - | - | - |
| 34 | 64,0 | - | - | 61,5 | - | - | 59,5 | - | - | - | 56,5 | - | - | - | - | - | - |
| 38 | 56,5 | - | - | 54,0 | - | - | 52,5 | - | - | - | 50,0 | - | - | - | - | - | - |
| 42 | 50,0 | - | - | 48,5 | - | - | 46,7 | - | - | - | 44,5 | - | - | - | - | - | - |
| 43 | 48,5 | 34,4 | - | 47,2 | - | - | 45,5 | - | - | - | 43,2 | - | - | - | - | - | - |
| 46 | 44,2 | 30,8 | - | 43,4 | 29,3 | - | 41,9 | - | - | - | 39,7 | - | - | - | - | - | - |
| 48 | 41,6 | 28,7 | - | 40,8 | 27,3 | - | 39,7 | 25,9 | - | - | 37,6 | - | - | - | - | - | - |
| 50 | 39,1 | 26,6 | - | 38,2 | 25,4 | - | 37,7 | 24,3 | - | - | 35,6 | - | - | - | - | - | - |
| 51 | 38,0 | 25,7 | - | 37,1 | 24,5 | - | 36,6 | 23,4 | - | - | 34,7 | 21,4 | - | - | - | - | - |
| 54 | 34,9 | 23,1 | - | 34,0 | 21,9 | - | 33,4 | 21,0 | - | - | 32,1 | 19,4 | - | - | - | - | - |
| 58 | 29,7* | 20,2 | - | 30,4 | 18,9 | - | 29,8 | 18,1 | - | - | 29,0 | 17,0 | - | - | - | - | - |
| 59 | 28,9* | 19,6 | - | 29,6 | 18,2 | - | 29,0 | 17,4 | - | - | 28,2 | 16,4 | - | - | - | - | - |
| 61 | - | 18,3 | 9,6 | 28,1 | 17,0 | - | 27,4 | 16,2 | - | - | 26,8 | 15,2 | - | - | - | - | - |
| 62 | - | 17,7 | 9,2 | 27,4 | 16,4 | - | 26,7 | 15,6 | - | - | 26,1 | 14,6 | - | - | - | - | - |
| 64 | - | 16,6 | 8,3 | 24,3* | 15,3 | 6,9 | 25,3 | 14,5 | - | - | 24,6 | 13,5 | - | - | - | - | - |
| 65 | - | 16,1 | 7,9 | 23,7* | 14,8 | 6,5 | 24,6 | 13,9 | - | - | 23,9 | 13,0 | - | - | - | - | - |
| 66 | - | 15,6 | 7,5 | - | 14,3 | 6,1 | 24,0 | 13,4 | - | - | 23,2 | 12,5 | - | - | - | - | - |
| 70 | - | 13,9 | 6,1 | - | 12,5 | 4,7 | 19,9* | 11,5 | - | - | 20,7 | 10,6 | - | - | - | - | - |
| 71 | - | - | 5,8 | - | 12,0 | 4,4 | 19,4* | 11,1 | - | - | 20,1 | 10,1 | - | - | - | - | - |
| 72 | - | - | 5,5 | - | 11,6 | 4,1 | - | 10,7 | - | - | 19,6 | 9,7 | - | - | - | - | - |
| 74 | - | - | 4,9 | - | 10,9 | - | - | 9,9 | - | - | 18,5 | 8,9 | - | - | - | - | - |
| 76 | - | - | 4,4 | - | 10,2 | - | - | 9,2 | - | - | 15,9* | 8,2 | - | - | - | - | - |
| 77 | - | - | 4,2 | - | - | - | - | 8,8 | - | - | 15,5* | 7,8 | - | - | - | - | - |
| 78 | - | - | - | - | - | - | - | 8,5 | - | - | - | 7,5 | - | - | - | - | - |
| 81 | - | - | - | - | - | - | - | 7,6 | - | - | - | 6,5 | - | - | - | - | - |
| 82 | - | - | - | - | - | - | - | - | - | - | - | 6,2 | - | - | - | - | - |
| 86 | - | - | - | - | - | - | - | - | - | - | - | 5,1 | - | - | - | - | - |
| 87 | - | - | - | - | - | - | - | - | - | - | - | 4,8 | - | - | - | - | - |

* Main boom angle 85° · Hauptauslegerwinkel 85° · Jarret de flèche principale 85° · Inclinazione braccio base 85° ·
 Ángulo de pluma principal 85° · Ângulo da lança principal 85° · Угол подъема гл. стрелы 85°

Main boom angle 87°, 85°, 75° and 65°, capacities for intermediate boom positions are calculated by the crane control system IC-1 ·
 Hauptauslegerwinkel 87°, 85°, 75° und 65°, Traglasten für Zwischenstellungen des Hauptauslegers werden von der Kransteuerung IC-1
 berechnet · Jarret de flèche principale 87°, 85°, 75° et 65°, le système de commande de la grue IC-1 calcule les charges pour les positions
 intermédiaires de la flèche · Inclinazione braccio base 87°, 85°, 75° e 65°, capacità per posizioni intermedie del braccio sono calcolate dal
 sistema di controllo della gru IC-1 · Ángulo de pluma principal 87°, 85°, 75° y 65°, las capacidades para posiciones de pluma intermedias
 son calculadas por el sistema de control de grúa IC-1 · Ângulos da lança principal 87°, 85°, 75° e 65°; as capacidades para posições da
 lança intermediária são calculadas pelo sistema de controle da grua IC-1 · Грузоподъемность при углах подъема главной стрелы
 87°, 85°, 75° и 65°, грузоподъемность в промежуточных положениях стрелы рассчитывается системой управления краном IC-1

| 205 t + 50 t | | 8,40 m | | 9.8 m/s | | 360° | | ISO | | | | | | | | | |
|--------------|-------|--------|------|---------|------|------|------|------|---------|---|------|-----|---|---|-----|---|---|
| 60 m | | | | | | | | | | | | | | | | | |
| 78 m | | | 84 m | | | 90 m | | | 96 m | | | | | | | | |
| SW_1 | | | | | | | | | | | | | | | | | |
| 87°/85° | | | 75° | | | 65° | | | 87°/85° | | | 75° | | | 65° | | |
| m | t | t | t | t | t | t | t | t | t | t | t | t | t | t | t | t | t |
| 25 | 64,5 | - | - | - | - | - | - | - | - | - | - | - | - | - | - | - | - |
| 26 | 64,0 | - | - | 56,0 | - | - | - | - | - | - | - | - | - | - | - | - | - |
| 27 | 63,7 | - | - | 55,7 | - | - | 48,2 | - | - | - | - | - | - | - | - | - | - |
| 28 | 63,5 | - | - | 55,5 | - | - | 47,9 | - | - | - | - | - | - | - | - | - | - |
| 29 | 63,0 | - | - | 55,2 | - | - | 47,7 | - | - | - | 41,2 | - | - | - | - | - | - |
| 30 | 62,5 | - | - | 55,0 | - | - | 47,5 | - | - | - | 41,0 | - | - | - | - | - | - |
| 34 | 54,5 | - | - | 52,0 | - | - | 46,5 | - | - | - | 40,3 | - | - | - | - | - | - |
| 38 | 48,1 | - | - | 45,8 | - | - | 44,0 | - | - | - | 39,4 | - | - | - | - | - | - |
| 42 | 42,6 | - | - | 40,4 | - | - | 38,7 | - | - | - | 36,5 | - | - | - | - | - | - |
| 46 | 37,9 | - | - | 35,8 | - | - | 34,2 | - | - | - | 32,1 | - | - | - | - | - | - |
| 50 | 33,9 | - | - | 31,9 | - | - | 30,3 | - | - | - | 28,3 | - | - | - | - | - | - |
| 53 | 31,2 | 18,3 | - | 29,3 | - | - | 27,7 | - | - | - | 25,8 | - | - | - | - | - | - |
| 54 | 30,4 | 17,7 | - | 28,5 | - | - | 26,9 | - | - | - | 25,0 | - | - | - | - | - | - |
| 56 | 28,8 | 16,5 | - | 26,9 | 14,4 | - | 25,4 | - | - | - | 23,5 | - | - | - | - | - | - |
| 58 | 27,3 | 15,3 | - | 25,4 | 13,3 | - | 24,0 | 11,7 | - | - | 22,1 | - | - | - | - | - | - |
| 61 | 25,3 | 13,8 | - | 23,4 | 11,8 | - | 21,9 | 10,2 | - | - | 20,1 | 8,3 | - | - | - | - | - |
| 62 | 24,7 | 13,3 | - | 22,8 | 11,3 | - | 21,3 | 9,8 | - | - | 19,5 | 7,8 | - | - | - | - | - |
| 66 | 22,3 | 11,5 | - | 20,4 | 9,5 | - | 19,0 | 8,0 | - | - | 17,2 | 6,1 | - | - | - | - | - |
| 70 | 19,9 | 9,7 | - | 18,3 | 7,9 | - | 16,9 | 6,5 | - | - | 15,2 | 4,6 | - | - | - | - | - |
| 71 | 19,3 | 9,2 | - | 17,8 | 7,5 | - | 16,4 | 6,1 | - | - | 14,7 | 4,2 | - | - | - | - | - |
| 74 | 17,7 | 8,0 | - | 16,3 | 6,5 | - | 15,0 | 5,1 | - | - | 13,3 | - | - | - | - | - | - |
| 77 | 16,2 | 6,8 | - | 14,8 | 5,3 | - | 13,7 | 4,1 | - | - | 12,0 | - | - | - | - | - | - |
| 78 | 15,7 | 6,5 | - | 14,4 | 5,0 | - | 13,3 | - | - | - | 11,6 | - | - | - | - | - | - |
| 81 | 14,4 | 5,5 | - | 13,0 | 4,0 | - | 12,1 | - | - | - | 10,4 | - | - | - | - | - | - |
| 82 | 12,5* | 5,2 | - | 12,6 | - | - | 11,8 | - | - | - | 10,1 | - | - | - | - | - | - |
| 83 | 12,2* | 4,9 | - | 12,2 | - | - | 11,4 | - | - | - | 9,7 | - | - | - | - | - | - |
| 86 | - | 4,1 | - | 11,1 | - | - | 10,3 | - | - | - | 8,7 | - | - | - | - | - | - |
| 88 | - | - | - | 9,0* | - | - | 9,6 | - | - | - | 8,0 | - | - | - | - | - | - |
| 90 | - | - | - | - | - | - | 8,9 | - | - | - | 7,4 | - | - | - | - | - | - |
| 94 | - | - | - | - | - | - | 6,3* | - | - | - | 6,3 | - | - | - | - | - | - |
| 98 | - | - | - | - | - | - | - | - | - | - | 5,3 | - | - | - | - | - | - |

* Main boom angle 85° · Hauptauslegerwinkel 85° · Jarret de flèche principale 85° · Inclinazione braccio base 85° ·
 Ángulo de pluma principal 85° · Ângulo da lança principal 85° · Угол подъема гл. стрелы 85°

Main boom angle 87°, 85°, 75° and 65°, capacities for intermediate boom positions are calculated by the crane control system IC-1 ·
 Hauptauslegerwinkel 87°, 85°, 75° und 65°, Traglasten für Zwischenstellungen des Hauptauslegers werden von der Kransteuerung IC-1
 berechnet · Jarret de flèche principale 87°, 85°, 75° et 65°, le système de commande de la grue IC-1 calcule les charges pour les positions
 intermédiaires de la flèche · Inclinazione braccio base 87°, 85°, 75° e 65°, capacità per posizioni intermedie del braccio sono calcolate dal
 sistema di controllo della gru IC-1 · Ángulo de pluma principal 87°, 85°, 75° y 65°, las capacidades para posiciones de pluma intermedias
 son calculadas por el sistema de control de grúa IC-1 · Ângulos da lança principal 87°, 85°, 75° e 65°, as capacidades para posições da
 lança intermediária são calculadas pelo sistema de controle da grua IC-1 · Грузоподъемность при углах подъема главной стрелы
 87°, 85°, 75° и 65°, грузоподъемность в промежуточных положениях стрелы рассчитывается системой управления краном IC-1

| 205 t + 50 t | | 8,40 m | | 9.8 m/s | | 360° | | ISO | | | | | | | | | |
|--------------|-------|--------|------|---------|------|------|---|-------|---------|------|-------|------|------|-------|------|-----|--|
| 66 m | | | | | | | | | | | | | | | | | |
| 24 m | | | 30 m | | | 36 m | | | 42 m | | | 48 m | | | | | |
| SW_1 | | | | | | | | | | | | | | | | | |
| 87°/85° | | | 75° | | | 65° | | | 87°/85° | | | 75° | | | 65° | | |
| m | t | t | t | t | t | t | t | t | t | t | t | t | t | t | t | t | |
| 13 | 182,0 | - | - | - | - | - | - | - | - | - | - | - | - | - | - | - | |
| 14 | 171,0 | - | - | - | - | - | - | - | - | - | - | - | - | - | - | - | |
| 15 | 161,0 | - | - | 155,0 | - | - | - | - | - | - | - | - | - | - | - | - | |
| 16 | 152,0 | - | - | 147,0 | - | - | - | 141,0 | - | - | - | - | - | - | - | - | |
| 17 | 144,0 | - | - | 139,0 | - | - | - | 134,0 | - | - | 129,0 | - | - | - | - | - | |
| 18 | 137,0 | - | - | 132,0 | - | - | - | 127,0 | - | - | 123,0 | - | - | 118,0 | - | - | |
| 20 | 125,0 | - | - | 120,0 | - | - | - | 116,0 | - | - | 112,0 | - | - | 107,0 | - | - | |
| 22 | 114,0 | - | - | 110,0 | - | - | - | 106,0 | - | - | 103,0 | - | - | 98,5 | - | - | |
| 24 | 105,0 | - | - | 101,0 | - | - | - | 98,0 | - | - | 95,0 | - | - | 90,5 | - | - | |
| 26 | 98,0 | - | - | 94,5 | - | - | - | 90,5 | - | - | 88,0 | - | - | 84,0 | - | - | |
| 28 | 91,0 | - | - | 88,0 | - | - | - | 84,5 | - | - | 82,0 | - | - | 78,0 | - | - | |
| 30 | 79,5* | - | - | 81,5 | - | - | - | 79,0 | - | - | 76,5 | - | - | 73,0 | - | - | |
| 31 | 76,0* | - | - | 78,3 | - | - | - | 76,3 | - | - | 74,2 | - | - | 70,7 | - | - | |
| 32 | - | 57,0 | - | 75,2 | - | - | - | 73,7 | - | - | 72,0 | - | - | 68,5 | - | - | |
| 34 | - | 52,5 | - | 69,0 | - | - | - | 68,5 | - | - | 67,5 | - | - | 64,0 | - | - | |
| 35 | - | 50,6 | - | 63,6* | 48,9 | - | - | 66,1 | - | - | 65,2 | - | - | 62,2 | - | - | |
| 37 | - | 46,8 | - | 59,0* | 45,1 | - | - | 61,3 | 44,0 | - | 60,7 | - | - | 58,7 | - | - | |
| 38 | - | 45,0 | - | - | 43,2 | - | - | 59,0 | 42,2 | - | 58,5 | - | - | 57,0 | - | - | |
| 40 | - | 41,9 | - | - | 40,1 | - | - | 55,0 | 39,1 | - | 54,7 | 38,3 | - | 53,4 | - | - | |
| 42 | - | 38,9 | - | - | 37,0 | - | - | 49,0* | 36,1 | - | 51,0 | 35,4 | - | 49,8 | 33,5 | - | |
| 43 | - | - | - | - | 35,8 | - | - | 47,5* | 34,8 | - | 49,5 | 34,0 | - | 48,2 | 32,2 | - | |
| 46 | - | - | - | - | 32,2 | - | - | - | 31,2 | - | 45,0 | 30,5 | - | 43,7 | 28,6 | - | |
| 47 | - | - | 21,4 | - | 31,2 | - | - | - | 30,2 | - | 41,4* | 29,5 | - | 42,4 | 27,6 | - | |
| 48 | - | - | 20,6 | - | 30,2 | - | - | - | 29,2 | - | 40,2* | 28,5 | - | 41,2 | 26,6 | - | |
| 50 | - | - | 19,2 | - | - | 17,1 | - | - | 27,2 | - | - | 26,5 | - | 38,7 | 24,6 | - | |
| 53 | - | - | 17,3 | - | - | 15,3 | - | - | 24,8 | - | - | 24,0 | - | 33,5* | 22,1 | - | |
| 54 | - | - | - | - | - | 14,7 | - | 24,1 | 13,5 | - | - | 23,2 | - | 32,6* | 21,3 | - | |
| 57 | - | - | - | - | - | 13,2 | - | - | - | 11,9 | - | 21,1 | 11,0 | - | 19,2 | - | |
| 58 | - | - | - | - | - | 12,8 | - | - | - | 11,4 | - | 20,5 | 10,5 | - | 18,5 | - | |
| 59 | - | - | - | - | - | 12,4 | - | - | - | 11,0 | - | 19,9 | 10,0 | - | 17,9 | - | |
| 60 | - | - | - | - | - | - | - | - | - | 10,6 | - | 19,4 | 9,6 | - | 17,3 | 7,5 | |
| 62 | - | - | - | - | - | - | - | - | - | 9,8 | - | - | 8,8 | - | 16,2 | 6,7 | |
| 65 | - | - | - | - | - | - | - | - | - | 8,8 | - | - | 7,7 | - | 14,8 | 5,6 | |
| 66 | - | - | - | - | - | - | - | - | - | - | - | - | 7,4 | - | 14,4 | 5,3 | |
| 70 | - | - | - | - | - | - | - | - | - | - | - | - | 6,3 | - | - | 4,1 | |
| 71 | - | - | - | - | - | - | - | - | - | - | - | - | 6,1 | - | - | - | |

* Main boom angle 85° · Hauptauslegerwinkel 85° · Jarret de flèche principale 85° · Inclinazione braccio base 85° ·
 Ángulo de pluma principal 85° · Ângulo da lança principal 85° · Угол подъема гл. стрелы 85°

Main boom angle 87°, 85°, 75° and 65°, capacities for intermediate boom positions are calculated by the crane control system IC-1 ·
 Hauptauslegerwinkel 87°, 85°, 75° und 65°, Traglasten für Zwischenstellungen des Hauptauslegers werden von der Kransteuerung IC-1
 berechnet · Jarret de flèche principale 87°, 85°, 75° et 65°, le système de commande de la grue IC-1 calcule les charges pour les positions
 intermédiaires de la flèche · Inclinazione braccio base 87°, 85°, 75° e 65°, capacità per posizioni intermedie del braccio sono calcolate dal
 sistema di controllo della gru IC-1 · Ángulo de pluma principal 87°, 85°, 75° y 65°, las capacidades para posiciones de pluma intermedias
 son calculadas por el sistema de control de grúa IC-1 · Ângulos da lança principal 87°, 85°, 75° e 65°; as capacidades para posições da
 lança intermediária são calculadas pelo sistema de controle da grua IC-1 · Грузоподъемность при углах подъема главной стрелы
 87°, 85°, 75° и 65°, грузоподъемность в промежуточных положениях стрелы рассчитывается системой управления краном IC-1

| 205 t + 50 t | | 8,40 m | | 9.8 m/s | | 360° | | ISO | | | | | | | | | |
|--------------|-------|--------|------|---------|------|------|-------|------|---------|-------|------|-----|---|---|-----|--|--|
| 66 m | | | | | | | | | | | | | | | | | |
| 54 m | | | 60 m | | | 66 m | | | 72 m | | | | | | | | |
| SW_1 | | | | | | | | | | | | | | | | | |
| 87°/85° | | | 75° | | | 65° | | | 87°/85° | | | 75° | | | 65° | | |
| m | t | t | t | t | t | t | t | t | t | t | t | t | t | t | t | | |
| 20 | 102,0 | - | - | - | - | - | - | - | - | - | - | - | - | - | - | | |
| 21 | 98,5 | - | - | 90,0 | - | - | - | - | - | - | - | - | - | - | - | | |
| 22 | 95,0 | - | - | 89,0 | - | - | 78,5 | - | - | - | - | - | - | - | - | | |
| 24 | 87,5 | - | - | 84,5 | - | - | 77,0 | - | - | 67,0 | - | - | - | - | - | | |
| 26 | 81,0 | - | - | 78,0 | - | - | 75,5 | - | - | 66,0 | - | - | - | - | - | | |
| 28 | 75,5 | - | - | 72,5 | - | - | 70,0 | - | - | 65,0 | - | - | - | - | - | | |
| 30 | 70,5 | - | - | 67,5 | - | - | 65,5 | - | - | 62,5 | - | - | - | - | - | | |
| 34 | 62,0 | - | - | 59,5 | - | - | 57,0 | - | - | 54,5 | - | - | - | - | - | | |
| 38 | 55,0 | - | - | 52,5 | - | - | 50,5 | - | - | 48,4 | - | - | - | - | - | | |
| 42 | 49,1 | - | - | 46,9 | - | - | 45,2 | - | - | 42,9 | - | - | - | - | - | | |
| 45 | 45,1 | 29,4 | - | 43,3 | - | - | 41,5 | - | - | 39,4 | - | - | - | - | - | | |
| 46 | 43,8 | 28,5 | - | 42,1 | - | - | 40,5 | - | - | 38,3 | - | - | - | - | - | | |
| 48 | 41,2 | 26,5 | - | 40,0 | 24,8 | - | 38,4 | - | - | 36,3 | - | - | - | - | - | | |
| 50 | 38,7 | 24,5 | - | 37,9 | 23,2 | - | 36,4 | 21,6 | - | 34,3 | - | - | - | - | - | | |
| 53 | 35,5 | 22,0 | - | 34,6 | 20,7 | - | 33,7 | 19,6 | - | 31,7 | 17,4 | - | - | - | - | | |
| 54 | 34,5 | 21,2 | - | 33,6 | 19,9 | - | 32,9 | 19,0 | - | 30,9 | 16,8 | - | - | - | - | | |
| 58 | 31,0 | 18,4 | - | 30,1 | 17,1 | - | 29,4 | 16,2 | - | 27,9 | 14,6 | - | - | - | - | | |
| 60 | 27,6* | 17,2 | - | 28,5 | 15,9 | - | 27,9 | 15,0 | - | 26,5 | 13,6 | - | - | - | - | | |
| 62 | - | 16,0 | - | 27,0 | 14,7 | - | 26,4 | 13,8 | - | 25,2 | 12,7 | - | - | - | - | | |
| 64 | - | 15,0 | 5,7 | 23,7* | 13,7 | - | 25,0 | 12,8 | - | 24,0 | 11,8 | - | - | - | - | | |
| 66 | - | 14,0 | 5,0 | 22,5* | 12,7 | - | 23,6 | 11,8 | - | 22,8 | 10,9 | - | - | - | - | | |
| 69 | - | 12,7 | 4,0 | - | 11,3 | - | 21,8 | 10,4 | - | 21,0 | 9,5 | - | - | - | - | | |
| 70 | - | 12,3 | - | - | 10,9 | - | 19,3* | 10,0 | - | 20,4 | 9,1 | - | - | - | - | | |
| 71 | - | 11,9 | - | - | 10,5 | - | 18,8* | 9,6 | - | 19,8 | 8,7 | - | - | - | - | | |
| 72 | - | - | - | - | 10,1 | - | 18,3* | 9,2 | - | 19,3 | 8,3 | - | - | - | - | | |
| 74 | - | - | - | - | 9,4 | - | - | 8,4 | - | 18,2 | 7,5 | - | - | - | - | | |
| 77 | - | - | - | - | 8,4 | - | - | 7,4 | - | 15,0* | 6,4 | - | - | - | - | | |
| 78 | - | - | - | - | - | - | - | 7,1 | - | - | 6,1 | - | - | - | - | | |
| 82 | - | - | - | - | - | - | - | 5,9 | - | - | 4,9 | - | - | - | - | | |
| 83 | - | - | - | - | - | - | - | 5,7 | - | - | 4,6 | - | - | - | - | | |
| 85 | - | - | - | - | - | - | - | - | - | - | 4,0 | - | - | - | - | | |

* Main boom angle 85° · Hauptauslegerwinkel 85° · Jarret de flèche principale 85° · Inclinazione braccio base 85° · Ángulo de pluma principal 85° · Ângulo da lança principal 85° · Угол подъема гл. стрелы 85°

Main boom angle 87°, 85°, 75° and 65°, capacities for intermediate boom positions are calculated by the crane control system IC-1 · Hauptauslegerwinkel 87°, 85°, 75° und 65°, Traglasten für Zwischenstellungen des Hauptauslegers werden von der Kransteuerung IC-1 berechnet · Jarret de flèche principale 87°, 85°, 75° et 65°, le système de commande de la grue IC-1 calcule les charges pour les positions intermédiaires de la flèche · Inclinazione braccio base 87°, 85°, 75° e 65°, capacità per posizioni intermedie del braccio sono calcolate dal sistema di controllo della gru IC-1 · Ángulo de pluma principal 87°, 85°, 75° y 65°, las capacidades para posiciones de pluma intermedias son calculadas por el sistema de control de grúa IC-1 · Ângulos da lança principal 87°, 85°, 75° e 65°; as capacidades para posições da lança intermediária são calculadas pelo sistema de controle da grua IC-1 · Грузоподъемность при углах подъема главной стрелы 87°, 85°, 75° и 65°, грузоподъемность в промежуточных положениях стрелы рассчитывается системой управления краном IC-1

| 205 t + 50 t | | 8,40 m | | 9.8 m/s | | 360° | | ISO | | | | | | | | | |
|--------------|-------|--------|------|---------|------|------|------|-----|---------|---|------|-----|---|---|-----|---|---|
| 66 m | | | | | | | | | | | | | | | | | |
| 78 m | | | 84 m | | | 90 m | | | 96 m | | | | | | | | |
| SW_1 | | | | | | | | | | | | | | | | | |
| 87°/85° | | | 75° | | | 65° | | | 87°/85° | | | 75° | | | 65° | | |
| m | t | t | t | t | t | t | t | t | t | t | t | t | t | t | t | t | t |
| 25 | 58,0 | - | - | - | - | - | - | - | - | - | - | - | - | - | - | - | - |
| 26 | 57,5 | - | - | 50,0 | - | - | - | - | - | - | - | - | - | - | - | - | - |
| 28 | 57,0 | - | - | 49,9 | - | - | 43,1 | - | - | - | - | - | - | - | - | - | - |
| 29 | 56,5 | - | - | 49,6 | - | - | 42,8 | - | - | - | 36,9 | - | - | - | - | - | - |
| 30 | 56,0 | - | - | 49,3 | - | - | 42,6 | - | - | - | 36,7 | - | - | - | - | - | - |
| 34 | 52,5 | - | - | 48,1 | - | - | 41,7 | - | - | - | 36,0 | - | - | - | - | - | - |
| 38 | 46,4 | - | - | 44,1 | - | - | 40,5 | - | - | - | 35,1 | - | - | - | - | - | - |
| 42 | 41,0 | - | - | 38,9 | - | - | 37,1 | - | - | - | 34,2 | - | - | - | - | - | - |
| 46 | 36,5 | - | - | 34,4 | - | - | 32,8 | - | - | - | 30,7 | - | - | - | - | - | - |
| 50 | 32,6 | - | - | 30,6 | - | - | 29,0 | - | - | - | 27,0 | - | - | - | - | - | - |
| 54 | 29,2 | - | - | 27,3 | - | - | 25,7 | - | - | - | 23,8 | - | - | - | - | - | - |
| 55 | 28,4 | 14,6 | - | 26,5 | - | - | 25,0 | - | - | - | 23,1 | - | - | - | - | - | - |
| 58 | 26,3 | 13,0 | - | 24,4 | 10,9 | - | 22,9 | - | - | - | 21,0 | - | - | - | - | - | - |
| 60 | 24,9 | 12,0 | - | 23,1 | 10,0 | - | 21,6 | 8,4 | - | - | 19,7 | - | - | - | - | - | - |
| 62 | 23,6 | 11,1 | - | 21,8 | 9,1 | - | 20,3 | 7,5 | - | - | 18,5 | - | - | - | - | - | - |
| 66 | 21,3 | 9,4 | - | 19,5 | 7,4 | - | 18,1 | 5,9 | - | - | 16,3 | - | - | - | - | - | - |
| 70 | 19,2 | 7,9 | - | 17,4 | 5,9 | - | 16,0 | 4,5 | - | - | 14,3 | - | - | - | - | - | - |
| 71 | 18,7 | 7,5 | - | 16,9 | 5,5 | - | 15,5 | 4,1 | - | - | 13,8 | - | - | - | - | - | - |
| 74 | 17,4 | 6,5 | - | 15,6 | 4,6 | - | 14,2 | - | - | - | 12,5 | - | - | - | - | - | - |
| 75 | 16,9 | 6,1 | - | 15,1 | 4,3 | - | 13,8 | - | - | - | 12,0 | - | - | - | - | - | - |
| 78 | 15,4 | 5,2 | - | 13,9 | - | - | 12,6 | - | - | - | 10,8 | - | - | - | - | - | - |
| 81 | 14,1 | 4,2 | - | 12,7 | - | - | 11,4 | - | - | - | 9,6 | - | - | - | - | - | - |
| 82 | 12,1* | - | - | 12,3 | - | - | 11,0 | - | - | - | 9,3 | - | - | - | - | - | - |
| 83 | 11,7* | - | - | 11,9 | - | - | 10,6 | - | - | - | 8,9 | - | - | - | - | - | - |
| 86 | - | - | - | 10,8 | - | - | 9,7 | - | - | - | 8,0 | - | - | - | - | - | - |
| 89 | - | - | - | 8,2* | - | - | 8,8 | - | - | - | 7,0 | - | - | - | - | - | - |
| 90 | - | - | - | - | - | - | 8,5 | - | - | - | 6,7 | - | - | - | - | - | - |
| 94 | - | - | - | - | - | - | 5,7* | - | - | - | 5,6 | - | - | - | - | - | - |
| 95 | - | - | - | - | - | - | 5,5* | - | - | - | 5,3 | - | - | - | - | - | - |
| 98 | - | - | - | - | - | - | - | - | - | - | 4,6 | - | - | - | - | - | - |

* Main boom angle 85° · Hauptauslegerwinkel 85° · Jarret de flèche principale 85° · Inclinazione braccio base 85° ·
 Ângulo de pluma principal 85° · Ângulo da lança principal 85° · Угол подъема гл. стрелы 85°

Main boom angle 87°, 85°, 75° and 65°, capacities for intermediate boom positions are calculated by the crane control system IC-1 ·
 Hauptauslegerwinkel 87°, 85°, 75° und 65°, Traglasten für Zwischenstellungen des Hauptauslegers werden von der Kransteuerung IC-1
 berechnet · Jarret de flèche principale 87°, 85°, 75° et 65°, le système de commande de la grue IC-1 calcule les charges pour les positions
 intermédiaires de la flèche · Inclinazione braccio base 87°, 85°, 75° e 65°, capacità per posizioni intermedie del braccio sono calcolate dal
 sistema di controllo della gru IC-1 · Ângulo de pluma principal 87°, 85°, 75° y 65°, las capacidades para posiciones de pluma intermedias
 son calculadas por el sistema de control de grúa IC-1 · Ângulos da lança principal 87°, 85°, 75° e 65°, as capacidades para posições da
 lança intermediária são calculadas pelo sistema de controle da grua IC-1 · Грузоподъемность при углах подъема главной стрелы
 87°, 85°, 75° и 65°, грузоподъемность в промежуточных положениях стрелы рассчитывается системой управления краном IC-1

| 205 t + 50 t | | 8,40 m | | 9.8 m/s | | 360° | | ISO | | | |
|--------------|-------|--------|------|---------|------|---------|---|-----|---|-----|---|
| 72 m | | | | | | | | | | | |
| 42 m | | | 48 m | | | SW_1 | | | | | |
| 87°/85° | | 75° | | 65° | | 87°/85° | | 75° | | 65° | |
| m | t | t | t | t | t | t | t | t | t | t | t |
| 18 | 118,0 | - | - | - | - | - | - | - | - | - | - |
| 19 | 113,0 | - | - | 105,0 | - | - | - | - | - | - | - |
| 20 | 108,0 | - | - | 103,0 | - | - | - | - | - | - | - |
| 22 | 99,0 | - | - | 94,5 | - | - | - | - | - | - | - |
| 24 | 91,5 | - | - | 87,5 | - | - | - | - | - | - | - |
| 26 | 84,5 | - | - | 81,0 | - | - | - | - | - | - | - |
| 28 | 79,0 | - | - | 75,0 | - | - | - | - | - | - | - |
| 30 | 74,0 | - | - | 70,0 | - | - | - | - | - | - | - |
| 34 | 65,0 | - | - | 62,0 | - | - | - | - | - | - | - |
| 38 | 58,0 | - | - | 55,0 | - | - | - | - | - | - | - |
| 42 | 50,5 | 32,3 | - | 49,3 | - | - | - | - | - | - | - |
| 44 | 47,5 | 30,0 | - | 46,2 | 28,0 | - | - | - | - | - | - |
| 46 | 44,5 | 27,7 | - | 43,2 | 25,8 | - | - | - | - | - | - |
| 49 | 38,3* | 24,8 | - | 39,5 | 22,9 | - | - | - | - | - | - |
| 50 | - | 23,9 | - | 38,3 | 22,0 | - | - | - | - | - | - |
| 54 | - | 20,8 | - | 31,9* | 18,9 | - | - | - | - | - | - |
| 55 | - | 20,1 | - | 31,0* | 18,2 | - | - | - | - | - | - |
| 58 | - | 18,2 | - | - | 16,3 | - | - | - | - | - | - |
| 60 | - | 17,1 | 6,2 | - | 15,2 | - | - | - | - | - | - |
| 61 | - | 16,6 | 5,8 | - | 14,6 | - | - | - | - | - | - |
| 62 | - | - | 5,5 | - | 14,1 | - | - | - | - | - | - |
| 66 | - | - | 4,2 | - | 12,3 | - | - | - | - | - | - |
| 67 | - | - | - | - | 11,9 | - | - | - | - | - | - |

| 72 m | | | | | | | | | | | |
|---------|-------|------|------|-------|------|---------|-------|------|---|-----|---|
| 54 m | | | 60 m | | | 66 m | | | | | |
| SW_1 | | | | | | | | | | | |
| 87°/85° | | 75° | | 65° | | 87°/85° | | 75° | | 65° | |
| m | t | t | t | t | t | t | t | t | t | t | t |
| 20 | 93,0 | - | - | - | - | - | - | - | - | - | - |
| 21 | 92,0 | - | - | 81,5 | - | - | - | - | - | - | - |
| 22 | 91,0 | - | - | 81,0 | - | - | - | - | - | - | - |
| 23 | 87,7 | - | - | 80,2 | - | - | 69,5 | - | - | - | - |
| 24 | 84,5 | - | - | 79,5 | - | - | 69,0 | - | - | - | - |
| 26 | 78,0 | - | - | 75,0 | - | - | 68,0 | - | - | - | - |
| 28 | 72,5 | - | - | 70,0 | - | - | 66,5 | - | - | - | - |
| 30 | 68,0 | - | - | 65,0 | - | - | 63,0 | - | - | - | - |
| 34 | 59,5 | - | - | 57,0 | - | - | 55,0 | - | - | - | - |
| 38 | 53,0 | - | - | 50,5 | - | - | 48,8 | - | - | - | - |
| 42 | 47,4 | - | - | 45,2 | - | - | 43,4 | - | - | - | - |
| 46 | 42,7 | - | - | 40,6 | - | - | 38,9 | - | - | - | - |
| 47 | 41,6 | 24,3 | - | 39,6 | - | - | 37,9 | - | - | - | - |
| 49 | 39,5 | 22,7 | - | 37,6 | 20,8 | - | 35,9 | - | - | - | - |
| 50 | 38,3 | 22,0 | - | 36,6 | 20,1 | - | 35,0 | - | - | - | - |
| 52 | 36,2 | 20,4 | - | 34,9 | 18,8 | - | 33,3 | 17,2 | - | - | - |
| 54 | 34,1 | 18,9 | - | 33,2 | 17,6 | - | 31,6 | 16,0 | - | - | - |
| 58 | 30,6 | 16,2 | - | 29,7 | 14,9 | - | 28,6 | 14,0 | - | - | - |
| 60 | 26,9* | 15,0 | - | 28,2 | 13,7 | - | 27,3 | 12,9 | - | - | - |
| 62 | - | 13,9 | - | 26,7 | 12,7 | - | 26,0 | 11,8 | - | - | - |
| 66 | - | 12,0 | - | 21,8* | 10,7 | - | 23,2 | 9,8 | - | - | - |
| 70 | - | 10,4 | - | - | 9,1 | - | 20,8 | 8,1 | - | - | - |
| 72 | - | 9,7 | - | - | 8,3 | - | 17,7* | 7,4 | - | - | - |
| 73 | - | 9,4 | - | - | 7,9 | - | - | 7,0 | - | - | - |
| 74 | - | - | - | - | 7,6 | - | - | 6,7 | - | - | - |
| 78 | - | - | - | - | 6,4 | - | - | 5,4 | - | - | - |
| 79 | - | - | - | - | 6,2 | - | - | 5,1 | - | - | - |
| 82 | - | - | - | - | - | - | - | 4,3 | - | - | - |
| 83 | - | - | - | - | - | - | - | 4,1 | - | - | - |

For explanations see page 126 · Bemerkungen siehe Seite 126 · Pour plus de détails, voir page 126 ·
 Per spiegazioni vedere a pagina 126 · Véase página 126 para más información ·
 Para explicações, ver página 126 · Объяснения см. на стр. 126

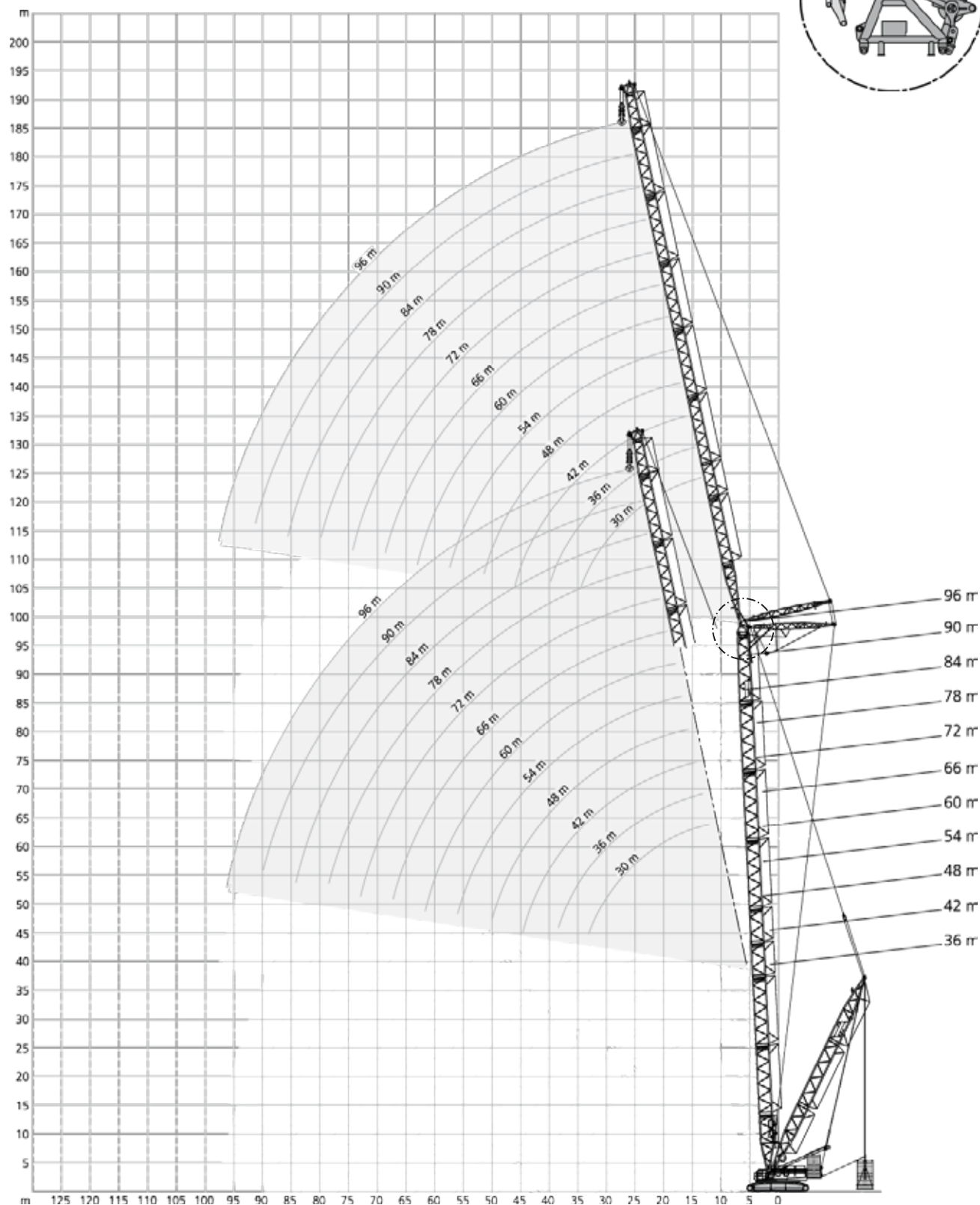
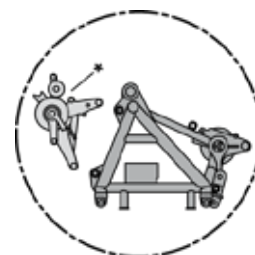

* Attachable · Anbaubar · Amovible · Montabile · Acoplable · Adaptável · Приставн

165 t + 50 t 11-19 m 8,40 m 9.8 m/s 360° ISO

| 36 m + 24 m | | SWSL_1 | | | | | SFSL_1 |
|-------------|---------|-----------|-------|-------|-------|-------|--------|
| 0 t | | 0 t-325 t | | | | | |
| | 87°/85° | 87°/85° | 75° | 65° | 55° | 15° | |
| m | t | t | t | t | t | t | |
| 24 | - | - | 347,0 | - | - | - | |
| 25 | - | - | 336,0 | - | - | 336,0 | |
| 26 | - | - | 324,0 | - | - | 323,0 | |
| 28 | - | - | 301,0 | - | - | 298,0 | |
| 30 | - | - | 280,0 | - | - | 276,0 | |
| 33 | - | - | 238,0 | 248,0 | - | 248,0 | |
| 34 | - | - | 224,0 | 240,0 | - | 238,6 | |
| 35 | - | - | 205,0 | 232,7 | - | 229,3 | |
| 38 | - | - | - | 211,0 | - | 204,6 | |
| 41 | - | - | - | 194,0 | - | 181,6 | |
| 42 | - | - | - | - | 173,0 | 174,0 | |
| 46 | - | - | - | - | 156,0 | 148,6 | |
| 50 | - | - | - | - | - | 125,3 | |
| 54 | - | - | - | - | - | 104,0 | |
| 57 | - | - | - | - | - | 89,5 | |

| 36 m + 60 m | | SWSL_1 | | | | | SFSL_1 |
|-------------|---------|-----------|-------|-------|------|-------|--------|
| 0 t | | 0 t-325 t | | | | | |
| | 87°/85° | 87°/85° | 75° | 65° | 55° | 15° | |
| m | t | t | t | t | t | t | |
| 39 | - | - | 139,0 | - | - | - | |
| 42 | - | - | 139,0 | - | - | - | |
| 43 | - | - | 139,0 | - | - | 142,0 | |
| 46 | - | - | 139,0 | - | - | 139,6 | |
| 50 | - | - | 131,0 | - | - | 136,0 | |
| 53 | - | - | 119,7 | 120,0 | - | 133,0 | |
| 54 | - | - | 116,0 | 120,0 | - | 132,0 | |
| 58 | - | - | 102,0 | 120,0 | - | 120,6 | |
| 62 | - | - | 90,0 | 110,0 | - | 109,3 | |
| 66 | - | - | 79,0 | 99,0 | - | 98,0 | |
| 67 | - | - | 76,0 | 96,3 | 92,5 | 95,4 | |
| 69 | - | - | 70,0 | 91,1 | 89,5 | 90,2 | |
| 70 | - | - | - | 88,5 | 87,5 | 87,6 | |
| 74 | - | - | - | 77,5 | 81,5 | 78,0 | |
| 75 | - | - | - | 74,5 | 80,2 | 75,7 | |
| 78 | - | - | - | - | 76,5 | 69,0 | |
| 81 | - | - | - | - | 73,0 | 62,6 | |
| 82 | - | - | - | - | - | 60,5 | |
| 86 | - | - | - | - | - | 52,5 | |
| 90 | - | - | - | - | - | 44,6 | |
| 91 | - | - | - | - | - | 42,5 | |

| 36 m + 36 m | | | | | | |
|-------------|---|---|-------|-------|-------|-------|
| m | t | t | t | t | t | t |
| 29 | - | - | 287,0 | - | - | - |
| 30 | - | - | 277,0 | - | - | - |
| 31 | - | - | 268,5 | - | - | 268,0 |
| 34 | - | - | 243,0 | - | - | 243,4 |
| 38 | - | - | 202,0 | - | - | 213,0 |
| 40 | - | - | 184,0 | 197,0 | - | 199,0 |
| 42 | - | - | 166,0 | 186,0 | - | 185,0 |
| 46 | - | - | 134,0 | 167,0 | - | 162,3 |
| 50 | - | - | - | 152,0 | 139,0 | 141,6 |
| 52 | - | - | - | 141,0 | 132,3 | 132,3 |
| 54 | - | - | - | - | 127,0 | 123,0 |
| 58 | - | - | - | - | 116,0 | 107,0 |
| 62 | - | - | - | - | - | 91,8 |
| 66 | - | - | - | - | - | 77,5 |
| 68 | - | - | - | - | - | 70,5 |

| 36 m + 72 m | | | | | | |
|-------------|---|---|------|------|------|------|
| m | t | t | t | t | t | t |
| 44 | - | - | 97,0 | - | - | - |
| 46 | - | - | 97,0 | - | - | - |
| 49 | - | - | 96,6 | - | - | 97,0 |
| 50 | - | - | 96,5 | - | - | 96,4 |
| 54 | - | - | 96,0 | - | - | 94,0 |
| 58 | - | - | 95,0 | - | - | 91,3 |
| 60 | - | - | 94,2 | 82,0 | - | 90,0 |
| 62 | - | - | 93,5 | 82,0 | - | 88,8 |
| 66 | - | - | 84,0 | 82,0 | - | 86,5 |
| 70 | - | - | 75,0 | 82,0 | - | 83,8 |
| 74 | - | - | 67,0 | 81,0 | - | 80,0 |
| 75 | - | - | 65,0 | 79,2 | 70,0 | 78,7 |
| 78 | - | - | 59,0 | 74,0 | 70,0 | 75,0 |
| 81 | - | - | 53,0 | 68,0 | 69,6 | 69,3 |
| 82 | - | - | - | 66,0 | 69,5 | 67,5 |
| 86 | - | - | - | 58,5 | 65,0 | 60,0 |
| 87 | - | - | - | 56,5 | 64,0 | 58,2 |
| 90 | - | - | - | - | 61,0 | 53,0 |
| 92 | - | - | - | - | 59,5 | 49,8 |
| 94 | - | - | - | - | - | 46,6 |
| 98 | - | - | - | - | - | 40,2 |
| 102 | - | - | - | - | - | 33,7 |
| 103 | - | - | - | - | - | 32,0 |

| 36 m + 48 m | | | | | | |
|-------------|---|---|-------|-------|-------|-------|
| m | t | t | t | t | t | t |
| 33 | - | - | 202,0 | - | - | - |
| 34 | - | - | 202,0 | - | - | - |
| 37 | - | - | 202,0 | - | - | 206,0 |
| 38 | - | - | 202,0 | - | - | 202,8 |
| 42 | - | - | 174,0 | - | - | 190,0 |
| 46 | - | - | 150,0 | - | - | 170,0 |
| 47 | - | - | 145,2 | 162,0 | - | 165,0 |
| 50 | - | - | 131,0 | 151,0 | - | 150,6 |
| 54 | - | - | 112,0 | 137,0 | - | 132,0 |
| 58 | - | - | 94,5 | 125,0 | - | 117,3 |
| 59 | - | - | - | 120,7 | 112,0 | 113,6 |
| 62 | - | - | - | 108,0 | 105,0 | 103,8 |
| 64 | - | - | - | 99,5 | 101,5 | 97,6 |
| 66 | - | - | - | - | 98,0 | 91,5 |
| 69 | - | - | - | - | 92,5 | 83,0 |
| 70 | - | - | - | - | - | 80,1 |
| 74 | - | - | - | - | - | 69,3 |
| 78 | - | - | - | - | - | 59,0 |
| 80 | - | - | - | - | - | 53,5 |

* Main boom angle 85° · Hauptauslegerwinkel 85° · Jarret de flèche principale 85° · Inclinazione braccio base 85° · Ángulo de pluma principal 85° · Ângulo da lança principal 85° · Угол подъема гл. стрелы 85°

see page 143 · siehe Seite 143 · voir page 143 · vedi pagina 143 · ver página 143 · ver página 143 · см. на стр. 143

0 t 65 t 125 t 165 t 205 t 245 t 285 t 325 t

| 165 t + 50 t | | | | | | | | 11-19 m | | 8,40 m | | 9.8 m/s | | 360° | | ISO | | | | | | | | | | | | | | | | | | | | | | | | | | | | | | | |
|--------------|---|---|------|------|------|------|------|-----------|-------|--------|-------|---------|-------|------|---|-----|-------|--------|-------|-------|-------|---|---|-----|---|---|---|---|---|---|---|-----|---|---|---|---|---|---|---|-----|--|--|--|--|--|--|--|
| 36 m + 84 m | | | | | | | | SWSL_1 | | SFSL_1 | | | | | | | | | | | | | | | | | | | | | | | | | | | | | | | | | | | | | |
| 0 t | | | | | | | | 0 t-325 t | | | | | | | | | | | | | | | | | | | | | | | | | | | | | | | | | | | | | | | |
| 87°/85° | | | | | | | | 87°/85° | | | | | | | | 75° | | | | | | | | 65° | | | | | | | | 55° | | | | | | | | 15° | | | | | | | |
| m | t | t | t | t | t | t | t | m | t | t | t | t | t | t | t | m | t | t | t | t | t | t | t | m | t | t | t | t | t | t | t | m | t | t | t | t | t | t | t | | | | | | | | |
| 49 | - | - | 66,5 | - | - | - | - | 11 | - | 347,0 | - | - | - | - | - | 12 | 233,0 | 347,0 | - | - | - | - | - | - | - | - | - | - | - | | | | | | | | | | | | | | | | | | |
| 50 | - | - | 66,5 | - | - | - | - | 14 | 202,0 | 347,0* | - | - | - | - | - | 16 | 177,0 | 347,0* | - | - | - | - | - | - | - | - | - | - | - | | | | | | | | | | | | | | | | | | |
| 54 | - | - | 66,0 | - | - | - | - | 18 | 158,0 | 347,0* | - | - | - | - | - | 20 | 143,0 | 347,0* | - | - | - | - | - | - | - | - | - | - | - | | | | | | | | | | | | | | | | | | |
| 55 | - | - | 65,8 | - | - | - | 66,0 | 22 | 130,0 | 331,0* | - | - | - | - | - | 24 | 115,0 | 291,0* | - | - | - | - | - | - | - | - | - | - | - | | | | | | | | | | | | | | | | | | |
| 58 | - | - | 65,5 | - | - | - | 64,0 | 25 | 109,5 | 270,5* | 333,0 | - | - | - | - | 26 | 104,0 | 250,0* | 321,0 | - | - | - | - | - | - | - | - | - | - | | | | | | | | | | | | | | | | | | |
| 62 | - | - | 65,0 | - | - | - | 61,5 | 27 | 98,5 | 231,5* | 309,0 | - | - | - | - | 28 | 92,0* | 213,0* | 297,0 | - | - | - | - | - | - | - | - | - | - | | | | | | | | | | | | | | | | | | |
| 66 | - | - | 64,0 | - | - | - | 61,0 | 29 | 88,0* | 194,0* | 287,0 | - | - | - | - | 30 | - | - | 277,0 | - | - | - | - | - | - | - | - | - | - | | | | | | | | | | | | | | | | | | |
| 67 | - | - | 63,8 | 55,0 | - | - | 59,5 | 34 | - | - | 244,0 | - | - | - | - | 36 | - | - | 213,0 | 223,0 | - | - | - | - | - | - | - | - | - | | | | | | | | | | | | | | | | | | |
| 70 | - | - | 63,5 | 55,0 | - | - | 57,6 | 38 | - | - | - | 211,0 | - | - | - | 38 | - | - | - | 211,0 | - | - | - | - | - | - | - | - | - | | | | | | | | | | | | | | | | | | |
| 74 | - | - | 63,0 | 55,0 | - | - | 56,0 | 42 | - | - | - | 189,0 | - | - | - | 42 | - | - | - | 189,0 | - | - | - | - | - | - | - | - | - | | | | | | | | | | | | | | | | | | |
| 78 | - | - | 62,0 | 55,0 | - | - | 54,6 | 43 | - | - | - | 184,0 | - | - | - | 43 | - | - | - | 184,0 | - | - | - | - | - | - | - | - | - | | | | | | | | | | | | | | | | | | |
| 82 | - | - | 56,0 | 55,0 | - | - | 54,0 | 46 | - | - | - | - | 165,0 | - | - | 46 | - | - | - | - | 165,0 | - | - | - | - | - | - | - | - | | | | | | | | | | | | | | | | | | |
| 84 | - | - | 53,0 | 55,0 | 47,6 | - | 54,0 | 50 | - | - | - | - | 150,0 | - | - | 50 | - | - | - | - | 150,0 | - | - | - | - | - | - | - | - | | | | | | | | | | | | | | | | | | |
| 86 | - | - | 50,0 | 55,0 | 47,6 | 53,3 | 52,0 | 54 | - | - | - | - | - | - | - | 54 | - | - | - | - | - | - | - | - | - | - | - | - | - | | | | | | | | | | | | | | | | | | |
| 90 | - | - | 44,4 | 55,0 | 47,6 | 52,0 | 49,7 | 58 | - | - | - | - | - | - | - | 58 | - | - | - | - | - | - | - | - | - | - | - | - | - | | | | | | | | | | | | | | | | | | |
| 93 | - | - | 39,7 | 51,2 | 47,6 | 50,3 | 45,8 | 62 | - | - | - | - | - | - | - | 62 | - | - | - | - | - | - | - | - | - | - | - | - | - | | | | | | | | | | | | | | | | | | |
| 94 | - | - | - | 50,0 | 47,6 | 49,7 | 44,4 | | | | | | | | | | | | | | | | | | | | | | | | | | | | | | | | | | | | | | | | |
| 98 | - | - | - | 44,4 | 47,6 | 45,8 | 44,4 | | | | | | | | | | | | | | | | | | | | | | | | | | | | | | | | | | | | | | | | |
| 99 | - | - | - | 42,8 | 47,6 | 44,4 | 40,3 | | | | | | | | | | | | | | | | | | | | | | | | | | | | | | | | | | | | | | | | |
| 102 | - | - | - | - | 47,6 | 40,3 | 37,6 | | | | | | | | | | | | | | | | | | | | | | | | | | | | | | | | | | | | | | | | |
| 104 | - | - | - | - | - | 46,3 | 35,0 | | | | | | | | | | | | | | | | | | | | | | | | | | | | | | | | | | | | | | | | |
| 106 | - | - | - | - | - | - | 29,7 | | | | | | | | | | | | | | | | | | | | | | | | | | | | | | | | | | | | | | | | |
| 110 | - | - | - | - | - | - | 24,3 | | | | | | | | | | | | | | | | | | | | | | | | | | | | | | | | | | | | | | | | |
| 114 | - | - | - | - | - | - | 22,8 | | | | | | | | | | | | | | | | | | | | | | | | | | | | | | | | | | | | | | | | |
| 115 | - | - | - | - | - | - | | | | | | | | | | | | | | | | | | | | | | | | | | | | | | | | | | | | | | | | | |

| 36 m + 96 m | | | | | | | | 42 m + 36 m | | | | | | | |
|-------------|---|---|------|------|------|------|---|-------------|-------|--------|-------|-------|-------|---|-------|
| m | t | t | t | t | t | t | t | m | t | t | t | t | t | t | t |
| 54 | - | - | 46,5 | - | - | - | - | 14 | 186,0 | 290,0 | - | - | - | - | - |
| 58 | - | - | 46,1 | - | - | - | - | 16 | 164,0 | 286,0 | - | - | - | - | - |
| 61 | - | - | 45,8 | - | - | 46,1 | - | 18 | 147,0 | 294,0* | - | - | - | - | - |
| 62 | - | - | 45,7 | - | - | 45,7 | - | 20 | 132,0 | 290,0* | - | - | - | - | - |
| 66 | - | - | 45,2 | - | - | 44,4 | - | 21 | 126,5 | 287,5* | - | - | - | - | 285,0 |
| 70 | - | - | 44,6 | - | - | 43,1 | - | 22 | 121,0 | 285,0* | - | - | - | - | 283,0 |
| 74 | - | - | 44,1 | 37,9 | - | 41,8 | - | 24 | 111,0 | 280,0* | - | - | - | - | 282,0 |
| 78 | - | - | 43,6 | 37,9 | - | 40,5 | - | 26 | 102,0 | 267,0* | - | - | - | - | 280,0 |
| 82 | - | - | 43,0 | 37,9 | - | 39,2 | - | 28 | 92,5 | 242,0* | - | - | - | - | 279,0 |
| 86 | - | - | 42,6 | 37,9 | - | 38,0 | - | 30 | 84,0 | 217,0* | 274,0 | - | - | - | 276,0 |
| 90 | - | - | 42,2 | 37,9 | - | 36,8 | - | 34 | 71,0 | 176,0* | 241,0 | - | - | - | 242,0 |
| 92 | - | - | 42,0 | 37,9 | 31,8 | 36,2 | - | 38 | 61,5 | 142,0* | 214,0 | - | - | - | 212,3 |
| 94 | - | - | 41,8 | 37,9 | 31,8 | 35,7 | - | 39 | 59,5 | 133,5* | 204,7 | - | - | - | 206,0 |
| 98 | - | - | 37,9 | 37,9 | 31,8 | 34,7 | - | 40 | 56,0* | 125,0* | 195,5 | - | - | - | 199,6 |
| 102 | - | - | 33,4 | 37,9 | 31,8 | 33,8 | - | 42 | - | - | 177,0 | - | - | - | 187,0 |
| 104 | - | - | 30,9 | 37,9 | 31,8 | 33,4 | - | 43 | - | - | 169,0 | 181,0 | - | - | 182,0 |
| 106 | - | - | - | 37,9 | 31,8 | 33,0 | - | 46 | - | - | 145,0 | 167,0 | - | - | 167,0 |
| 110 | - | - | - | 33,6 | 31,8 | 31,8 | - | 48 | - | - | 128,0 | 159,5 | - | - | 157,0 |
| 114 | - | - | - | - | 31,8 | 30,2 | - | 50 | - | - | - | 152,0 | - | - | 149,3 |
| 116 | - | - | - | - | 31,8 | 28,0 | - | 54 | - | - | - | 139,0 | 134,0 | - | 134,0 |
| 118 | - | - | - | - | - | 25,8 | - | 55 | - | - | - | 135,0 | 131,0 | - | 130,1 |
| 122 | - | - | - | - | - | 21,2 | - | 58 | - | - | - | - | 123,0 | - | 118,6 |
| 126 | - | - | - | - | - | 16,6 | - | 61 | - | - | - | - | 116,0 | - | 107,5 |
| | | | | | | | | 62 | - | - | - | - | - | - | 104,1 |
| | | | | | | | | 66 | - | - | - | - | - | - | 93,5 |
| | | | | | | | | 70 | - | - | - | - | - | - | 80,8 |
| | | | | | | | | 73 | - | - | - | - | - | - | 74,0 |

| | | | | | | | | |
|--|----|-----|------|------|------|------|------|------|
| | 0t | 65t | 125t | 165t | 205t | 245t | 285t | 325t |
|--|----|-----|------|------|------|------|------|------|

* Main boom angle 85° · Hauptauslegerwinkel 85° · Jarret de flèche principale 85° · Inclinação braccio base 85° · Ángulo de pluma principal 85° · Ángulo da lança principal 85° · Угол подъема гл. стрелы 85°

see page 143 · siehe Seite 143 · voir page 143 · vedi pagina 143 · ver página 143 · ver página 143 · см. на стр. 143

| 165 t + 50 t | | | | | | | 11-19 m | | 8,40 m | | 9.8 m/s | | 360° | | ISO | | |
|--------------|-------|---------|-------|-------|-------|-------|-----------|-----|--------|-----|---------|--------|------|------|------|-------|--|
| 42 m + 48 m | | | | | | | SWSL_1 | | SFSL_1 | | | | | | | | |
| 0 t | | | | | | | 0 t-325 t | | | | | | | | | | |
| 87°/85° | | 87°/85° | | 75° | | 65° | | 55° | | 15° | | | | | | | |
| m | t | t | t | t | t | t | t | t | t | m | t | t | t | t | t | t | |
| 17 | 144,0 | 203,0 | - | - | - | - | - | - | - | 22 | 98,0 | 105,0 | - | - | - | - | |
| 18 | 136,0 | 203,0 | - | - | - | - | - | - | - | 24 | 90,0 | 104,0 | - | - | - | - | |
| 20 | 123,0 | 205,0* | - | - | - | - | - | - | - | 26 | 83,0 | 104,0* | - | - | - | - | |
| 22 | 112,0 | 205,0* | - | - | - | - | - | - | - | 28 | 77,0 | 103,0* | - | - | - | - | |
| 24 | 103,0 | 204,0* | - | - | - | - | - | - | - | 30 | 71,5 | 103,0* | - | - | - | - | |
| 25 | 99,0 | 203,0* | - | - | - | - | - | - | - | 34 | 62,0 | 102,0* | - | - | - | 102,0 | |
| 26 | 95,0 | 202,0* | - | - | - | - | - | - | - | 38 | 54,5 | 100,0* | - | - | - | 100,3 | |
| 28 | 88,0 | 201,0* | - | - | - | - | - | - | - | 42 | 48,7 | 98,5* | - | - | - | 99,0 | |
| 30 | 82,0 | 198,0* | - | - | - | - | - | - | - | 45 | 44,8 | 97,0* | 92,5 | - | - | 97,5 | |
| 34 | 70,0 | 189,0* | - | - | - | - | - | - | - | 46 | 43,5 | 96,5* | 92,5 | - | - | 97,0 | |
| 35 | 67,5 | 181,5* | 191,0 | - | - | - | - | - | - | 50 | 38,4 | 94,5* | 92,5 | - | - | 94,6 | |
| 38 | 60,0 | 159,0* | 191,0 | - | - | - | - | - | - | 54 | 34,0 | 92,5* | 92,5 | - | - | 92,0 | |
| 42 | 52,5 | 135,0* | 188,0 | - | - | - | - | - | - | 58 | 30,3 | 85,0* | 92,5 | - | - | 89,6 | |
| 46 | 46,2 | 115,0* | 160,0 | - | - | - | - | - | - | 62 | 27,1 | 75,5* | 92,0 | - | - | 86,8 | |
| 50 | 41,1 | 97,0* | 137,0 | 149,0 | - | - | - | - | - | 63 | 26,4 | 73,2* | 90,7 | 78,0 | - | 86,2 | |
| 51 | 40,0 | 92,2* | 132,2 | 146,0 | - | - | - | - | - | 66 | 24,3 | 66,5* | 87,0 | 78,0 | - | 84,5 | |
| 52 | 37,8* | 87,5* | 127,5 | 142,6 | - | - | - | - | - | 70 | 21,8 | 58,5* | 77,5 | 78,0 | - | 82,1 | |
| 54 | - | - | 118,0 | 136,0 | - | - | - | - | - | 74 | 19,6 | 50,0* | 69,0 | 78,0 | - | 79,8 | |
| 58 | - | - | 100,0 | 125,0 | - | - | - | - | - | 75 | 18,1* | 48,0* | 67,0 | 78,0 | - | 79,2 | |
| 59 | - | - | 95,5 | 122,7 | - | - | - | - | - | 78 | - | - | 61,0 | 78,0 | - | 77,5 | |
| 62 | - | - | - | 116,0 | - | - | - | - | - | 79 | - | - | 59,0 | 76,1 | 66,0 | 77,0 | |
| 63 | - | - | - | 112,0 | 110,0 | - | - | - | - | 82 | - | - | 53,0 | 70,5 | 66,0 | 73,1 | |
| 66 | - | - | - | 100,0 | 104,0 | 102,0 | - | - | - | 83 | - | - | 50,5 | 68,5 | 66,0 | 71,8 | |
| 70 | - | - | - | - | 97,0 | 90,3 | - | - | - | 86 | - | - | - | 62,5 | 66,0 | 67,0 | |
| 73 | - | - | - | - | 92,0 | 82,1 | - | - | - | 89 | - | - | - | 56,5 | 65,6 | 61,7 | |
| 74 | - | - | - | - | - | 80,2 | - | - | - | 90 | - | - | - | - | 65,5 | 60,0 | |
| 78 | - | - | - | - | - | 72,0 | - | - | - | 94 | - | - | - | - | 61,5 | 55,0 | |
| 82 | - | - | - | - | - | 62,6 | - | - | - | 96 | - | - | - | - | 58,5 | 52,5 | |
| 85 | - | - | - | - | - | 57,5 | - | - | - | 98 | - | - | - | - | - | 49,3 | |
| | | | | | | | | | | 102 | - | - | - | - | - | 43,7 | |
| | | | | | | | | | | 106 | - | - | - | - | - | 38,3 | |
| | | | | | | | | | | 108 | - | - | - | - | - | 35,7 | |

| 42 m + 60 m | | | | | | |
|-------------|-------|--------|-------|-------|------|-------|
| m | t | t | t | t | t | t |
| 20 | 115,0 | 145,0 | - | - | - | - |
| 22 | 105,0 | 144,0 | - | - | - | - |
| 24 | 96,5 | 145,0* | - | - | - | - |
| 26 | 89,0 | 145,0* | - | - | - | - |
| 28 | 82,5 | 144,0* | - | - | - | - |
| 30 | 76,5 | 144,0* | - | - | - | 144,0 |
| 34 | 67,0 | 142,0* | - | - | - | 142,6 |
| 38 | 59,0 | 139,0* | - | - | - | 141,0 |
| 40 | 55,0 | 138,0* | 133,0 | - | - | 140,0 |
| 42 | 51,0 | 137,0* | 133,0 | - | - | 139,0 |
| 46 | 45,0 | 121,0* | 132,0 | - | - | 135,6 |
| 50 | 39,8 | 105,0* | 132,0 | - | - | 131,3 |
| 54 | 35,5 | 92,0* | 123,0 | - | - | 128,0 |
| 56 | 33,6 | 86,0* | 115,0 | 113,0 | - | 124,6 |
| 58 | 31,8 | 80,0* | 107,0 | 113,0 | - | 121,3 |
| 62 | 28,7 | 68,0* | 94,5 | 113,0 | - | 113,3 |
| 64 | 26,4* | 61,5* | 88,5 | 109,5 | - | 108,6 |
| 66 | - | - | 82,5 | 106,0 | - | 104,0 |
| 70 | - | - | 71,0 | 95,5 | - | 96,0 |
| 71 | - | - | 68,0 | 92,6 | 93,5 | 94,0 |
| 74 | - | - | - | 84,0 | 88,5 | 87,5 |
| 78 | - | - | - | 72,5 | 82,5 | 78,5 |
| 82 | - | - | - | - | 77,5 | 69,7 |
| 84 | - | - | - | - | 75,0 | 67,0 |
| 86 | - | - | - | - | - | 63,3 |
| 90 | - | - | - | - | - | 56,0 |
| 94 | - | - | - | - | - | 49,4 |
| 97 | - | - | - | - | - | 44,8 |

0 t 65 t 125 t 165 t 205 t 245 t 285 t 325 t

* Main boom angle 85° · Hauptauslegerwinkel 85° · Jarret de flèche principale 85° · Inclinazione braccio base 85° · Ángulo de pluma principal 85° · Ángulo da lança principal 85° · Угол подъема гл. стрелы 85°

Main boom angle 87°, 85°, 75°, 65° and 55°, capacities for intermediate boom positions are calculated by the crane control system IC-1 · Hauptauslegerwinkel 87°, 85°, 75°, 65° und 55°, Traglasten für Zwischenstellungen des Hauptauslegers werden von der Kransteuerung IC-1 berechnet · Jarret de flèche principale 87°, 85°, 75°, 65° et 55°, le système de commande de la grue IC-1 calcule les charges pour les positions intermédiaires de la flèche · Inclinazione braccio base 87°, 85°, 75°, 65° e 55°, capacità per posizioni intermedie del braccio sono calcolate dal sistema di controllo della gru IC-1 · Ángulo de pluma principal 87°, 85°, 75°, 65° y 55°, las capacidades para posiciones de pluma intermedias son calculadas por el sistema de control de grúa IC-1 · Ángulos da lança principal 87°, 85°, 75°, 65° e 55°, as capacidades para posições da lança intermediária são calculadas pelo sistema de controle da grua IC-1 · Грузоподъемность при углах подъема главной стрелы 87°, 85°, 75°, 65° и 55°, грузоподъемность в промежуточных положениях стрелы рассчитывается системой управления краном IC-1

| 165 t + 50 t | | | | | | | | 11-19 m | | | | | | | | 8,40 m | | | | | | | | 9.8 m/s | | | | | | | | 360° | | | | | | | | ISO | | | | | | | | | | | | | | | | | | | | | | | | | | | | | | | | | | | | | | | | | | | | | | | | | | | | | | | | | | | | | | | | | | | | | | | | | | | | | | | | | | | | | | | | | | | | | | | | | | | | | | | | | | | | | | | | | | | | | | | | | | | | | | | | | | | | | | | | | | | | | | | | | | | | | | | | | | | | | | | | | | | | | | | | | | | | | | | | | | | | | | | | | | | | | | | | | | | | | | | | | | | | | | | | | | | | | | | | | | | | | | | | | | | | | | | | | | | | | | | | | | | | | | | | | | |
|--------------|------|------|---|---|---|---|---|-----------|------|------|---|---|---|---|---|--------|------|------|---|---|---|---|---|-------------|---|---|----|------|-------|---|---|--------|---|---|----|------|-------|---|---|-----------|---|---|----|------|-------|---|---|---------|---|---|----|------|-------|---|---|---------|---|---|----|------|-------|---|---|-----|---|---|----|------|-------|---|---|-----|---|---|----|------|-------|---|---|-----|---|---|----|------|-------|------|---|-----|---|---|----|------|-------|------|---|---|---|---|----|------|-------|------|---|---|---|---|----|------|-------|------|---|---|---|---|----|------|-------|------|---|---|---|---|----|------|-------|------|---|---|---|---|----|------|-------|------|------|---|---|---|----|------|-------|------|------|---|---|---|----|------|-------|------|------|---|---|---|----|------|-------|------|------|---|---|---|----|-----|-------|------|------|---|---|---|----|-----|-------|------|------|---|---|---|----|-----|-------|------|------|------|---|---|----|-----|-------|------|------|------|---|---|----|------|-------|------|------|------|---|---|-----|---|---|------|------|------|---|---|-----|---|---|------|------|------|---|---|-----|---|---|---|------|------|---|---|-----|---|---|---|------|------|---|---|-----|---|---|---|---|------|---|---|-----|---|---|---|---|------|---|---|-----|---|---|---|---|------|---|---|-----|---|---|---|---|---|---|---|-----|---|---|---|---|---|---|---|-----|---|---|---|---|---|---|---|-----|---|---|---|---|---|---|---|
| 42 m + 84 m | | | | | | | | SWSL_1 | | | | | | | | SFSL_1 | | | | | | | | 42 m + 96 m | | | | | | | | SWSL_1 | | | | | | | | SFSL_1 | | | | | | | | | | | | | | | | | | | | | | | | | | | | | | | | | | | | | | | | | | | | | | | | | | | | | | | | | | | | | | | | | | | | | | | | | | | | | | | | | | | | | | | | | | | | | | | | | | | | | | | | | | | | | | | | | | | | | | | | | | | | | | | | | | | | | | | | | | | | | | | | | | | | | | | | | | | | | | | | | | | | | | | | | | | | | | | | | | | | | | | | | | | | | | | | | | | | | | | | | | | | | | | | | | | | | | | | | | | | | | | | | | | | | | | | | | | | | | | | | | | | | | | | | | |
| 0 t | | | | | | | | 0 t-325 t | | | | | | | | 0 t | | | | | | | | 0 t-325 t | | | | | | | | 0 t | | | | | | | | 0 t-325 t | | | | | | | | | | | | | | | | | | | | | | | | | | | | | | | | | | | | | | | | | | | | | | | | | | | | | | | | | | | | | | | | | | | | | | | | | | | | | | | | | | | | | | | | | | | | | | | | | | | | | | | | | | | | | | | | | | | | | | | | | | | | | | | | | | | | | | | | | | | | | | | | | | | | | | | | | | | | | | | | | | | | | | | | | | | | | | | | | | | | | | | | | | | | | | | | | | | | | | | | | | | | | | | | | | | | | | | | | | | | | | | | | | | | | | | | | | | | | | | | | | | | | | | | | | |
| 87°/85° | | | | | | | | 87°/85° | | | | | | | | 75° | | | | | | | | 65° | | | | | | | | 55° | | | | | | | | 15° | | | | | | | | 87°/85° | | | | | | | | 87°/85° | | | | | | | | 75° | | | | | | | | 65° | | | | | | | | 55° | | | | | | | | 15° | | | | | | | | | | | | | | | | | | | | | | | | | | | | | | | | | | | | | | | | | | | | | | | | | | | | | | | | | | | | | | | | | | | | | | | | | | | | | | | | | | | | | | | | | | | | | | | | | | | | | | | | | | | | | | | | | | | | | | | | | | | | | | | | | | | | | | | | | | | | | | | | | | | | | | | | | | | | | | | | | | | | | | | | | | | | | | | | | | | | | | | | | | | | | | | | | | | | | | | | | | |
| m | t | t | t | t | t | t | t | m | t | t | t | t | t | t | t | m | t | t | t | t | t | t | t | m | t | t | t | t | t | t | t | m | t | t | t | t | t | t | t | m | t | t | t | t | t | t | t | m | t | t | t | t | t | t | t | m | t | t | t | t | t | t | t | | | | | | | | | | | | | | | | | | | | | | | | | | | | | | | | | | | | | | | | | | | | | | | | | | | | | | | | | | | | | | | | | | | | | | | | | | | | | | | | | | | | | | | | | | | | | | | | | | | | | | | | | | | | | | | | | | | | | | | | | | | | | | | | | | | | | | | | | | | | | | | | | | | | | | | | | | | | | | | | | | | | | | | | | | | | | | | | | | | | | | | | | | | | | | | | | | | | | | | | | | | | | | | | | | | | | | | | | | | | | | | | | | | |
| 25 | 73,5 | 75,0 | - | - | - | - | - | 28 | 53,0 | 54,5 | - | - | - | - | - | 30 | 52,5 | 54,0 | - | - | - | - | - | - | - | - | 34 | 51,5 | 52,5* | - | - | - | - | - | 38 | 46,4 | 51,5* | - | - | - | - | - | 40 | 43,5 | 51,0* | - | - | - | - | - | 42 | 40,7 | 50,5* | - | - | - | - | - | 46 | 35,8 | 49,9* | - | - | - | - | - | 50 | 31,7 | 48,9* | - | - | - | - | - | 54 | 28,1 | 47,8* | - | - | - | - | - | 55 | 27,3 | 47,5* | 44,7 | - | - | - | - | 58 | 24,9 | 46,8* | 44,5 | - | - | - | - | 62 | 22,1 | 45,9* | 44,3 | - | - | - | - | 66 | 19,6 | 44,9* | 43,9 | - | - | - | - | 70 | 17,4 | 43,9* | 43,5 | - | - | - | - | 74 | 15,4 | 43,1* | 43,1 | - | - | - | - | 77 | 14,0 | 42,5* | 42,7 | 36,0 | - | - | - | 78 | 13,6 | 42,3* | 42,6 | 36,0 | - | - | - | 82 | 11,9 | 41,5* | 42,2 | 36,0 | - | - | - | 86 | 10,2 | 40,6* | 41,8 | 36,0 | - | - | - | 90 | 8,8 | 36,7* | 41,5 | 36,0 | - | - | - | 94 | 7,4 | 32,1* | 41,2 | 36,0 | - | - | - | 96 | 6,8 | 29,6* | 40,0 | 36,0 | 29,8 | - | - | 97 | 6,5 | 28,4* | 39,4 | 36,0 | 29,8 | - | - | 98 | 5,4* | 27,2* | 38,9 | 36,0 | 29,8 | - | - | 102 | - | - | 34,4 | 36,0 | 29,8 | - | - | 106 | - | - | 29,6 | 36,0 | 29,8 | - | - | 110 | - | - | - | 35,9 | 29,8 | - | - | 113 | - | - | - | 32,4 | 29,8 | - | - | 114 | - | - | - | - | 29,8 | - | - | 118 | - | - | - | - | 29,8 | - | - | 119 | - | - | - | - | 29,8 | - | - | 122 | - | - | - | - | - | - | - | 126 | - | - | - | - | - | - | - | 130 | - | - | - | - | - | - | - | 131 | - | - | - | - | - | - | - |

* Main boom angle 85° · Hauptauslegerwinkel 85° · Jarret de flèche principale 85° · Inclinazione braccio base 85° · Ángulo de pluma principal 85° · Ângulo da lança principal 85° · Угол подъема гл. стрелы 85°

Main boom angle 87°, 85°, 75°, 65° and 55°, capacities for intermediate boom positions are calculated by the crane control system IC-1 · Hauptauslegerwinkel 87°, 85°, 75°, 65° und 55°, Traglasten für Zwischenstellungen des Hauptauslegers werden von der Kransteuerung IC-1 berechnet · Jarret de flèche principale 87°, 85°, 75°, 65° et 55°, le système de commande de la grue IC-1 calcule les charges pour les positions intermédiaires de la flèche · Inclinazione braccio base 87°, 85°, 75°, 65° e 55°, capacità per posizioni intermedie del braccio sono calcolate dal sistema di controllo della gru IC-1 · Ángulo de pluma principal 87°, 85°, 75°, 65° y 55°, las capacidades para posiciones de pluma intermedias son calculadas por el sistema de control de grúa IC-1 · Ângulos da lança principal 87°, 85°, 75°, 65° e 55°; as capacidades para posições da lança intermediária são calculadas pelo sistema de controle da grua IC-1 · Грузоподъемность при углах подъема главной стрелы 87°, 85°, 75°, 65° и 55°, грузоподъемность в промежуточных положениях стрелы рассчитывается системой управления краном IC-1

| 165 t + 50 t | | 11-19 m | | 8,40 m | | 9.8 m/s | | 360° | | ISO | |
|--------------|-------|-----------|-------|--------|-------|---------|-------|--------|------|-----------|---|
| 48 m + 24 m | | SWSL_1 | | | | | | SFSL_1 | | | |
| 0 t | | 0 t-325 t | | | | | | 0 t | | 0 t-325 t | |
| 87°/85° | | 87°/85° | | 75° | | 65° | | 55° | | 15° | |
| m | t | t | t | t | t | t | t | t | t | t | t |
| 12 | 222,0 | 347,0 | - | - | - | - | - | - | - | - | - |
| 14 | 193,0 | 347,0* | - | - | - | - | - | - | - | - | - |
| 16 | 170,0 | 347,0* | - | - | - | - | - | - | - | 347,0 | - |
| 18 | 152,0 | 347,0* | - | - | - | - | - | - | - | 347,0 | - |
| 20 | 138,0 | 343,0* | - | - | - | - | - | - | - | 347,0 | - |
| 22 | 126,0 | 328,0* | - | - | - | - | - | - | - | 347,0 | - |
| 24 | 115,0 | 301,0* | - | - | - | - | - | - | - | 345,0 | - |
| 26 | 103,0 | 262,0* | - | - | - | - | - | - | - | 319,0 | - |
| 27 | 98,2 | 243,0* | 305,0 | - | - | - | - | - | - | 306,5 | - |
| 28 | 93,5 | 224,0* | 294,0 | - | - | - | - | - | - | 294,0 | - |
| 29 | 87,0* | 206,0* | 284,0 | - | - | - | - | - | - | 283,0 | - |
| 30 | - | - | 274,0 | - | - | - | - | - | - | 272,0 | - |
| 34 | - | - | 241,0 | - | - | - | - | - | - | 238,0 | - |
| 38 | - | - | 205,0 | - | - | - | - | - | - | 208,6 | - |
| 39 | - | - | - | 201,0 | - | - | - | - | - | 202,5 | - |
| 42 | - | - | - | 186,0 | - | - | - | - | - | 184,0 | - |
| 46 | - | - | - | 167,0 | - | - | - | - | - | 164,0 | - |
| 49 | - | - | - | - | 150,0 | - | - | - | - | 150,1 | - |
| 50 | - | - | - | - | 146,0 | - | - | - | - | 146,3 | - |
| 53 | - | - | - | - | 137,0 | - | - | - | - | 134,8 | - |
| 54 | - | - | - | - | - | 131,0 | - | - | - | 131,0 | - |
| 58 | - | - | - | - | - | - | 115,0 | - | - | 115,0 | - |
| 62 | - | - | - | - | - | - | - | 99,0 | - | 99,0 | - |
| 66 | - | - | - | - | - | - | - | - | 87,0 | 87,0 | - |
| 67 | - | - | - | - | - | - | - | - | - | 83,0 | - |

| 48 m + 36 m | | | | | | | |
|-------------|-------|--------|-------|-------|-------|------|-------|
| m | t | t | t | t | t | t | t |
| 14 | 178,0 | 264,0 | - | - | - | - | - |
| 16 | 158,0 | 261,0 | - | - | - | - | - |
| 18 | 141,0 | 269,0* | - | - | - | - | - |
| 20 | 128,0 | 266,0* | - | - | - | - | 259,0 |
| 22 | 117,0 | 262,0* | - | - | - | - | 259,0 |
| 24 | 107,0 | 258,0* | - | - | - | - | 258,0 |
| 26 | 99,0 | 250,0* | - | - | - | - | 257,0 |
| 28 | 92,0 | 243,0* | - | - | - | - | 255,0 |
| 30 | 84,0 | 225,0* | - | - | - | - | 254,0 |
| 32 | 77,5 | 203,5* | 254,0 | - | - | - | 242,3 |
| 34 | 71,0 | 182,0* | 238,0 | - | - | - | 232,6 |
| 38 | 61,5 | 148,0* | 212,0 | - | - | - | 210,6 |
| 39 | 59,0 | 139,6* | 206,7 | - | - | - | 204,5 |
| 41 | 53,5* | 123,0* | 196,2 | - | - | - | 192,1 |
| 42 | - | - | 191,0 | - | - | - | 186,0 |
| 46 | - | - | 158,0 | 165,0 | - | - | 166,0 |
| 49 | - | - | 134,0 | 153,0 | - | - | 152,1 |
| 50 | - | - | - | 149,0 | - | - | 148,3 |
| 54 | - | - | - | 136,0 | - | - | 133,0 |
| 57 | - | - | - | 128,0 | - | - | 124,0 |
| 58 | - | - | - | - | 121,0 | - | 121,0 |
| 62 | - | - | - | - | 111,0 | - | 109,8 |
| 65 | - | - | - | - | 106,0 | - | 102,0 |
| 66 | - | - | - | - | - | 99,5 | 99,5 |
| 70 | - | - | - | - | - | 87,1 | 87,1 |
| 74 | - | - | - | - | - | 77,4 | 77,4 |
| 78 | - | - | - | - | - | 67,0 | 67,0 |
| 79 | - | - | - | - | - | 64,5 | 64,5 |

0 t 65 t 125 t 165 t 205 t 245 t 285 t 325 t

* Main boom angle 85° · Hauptauslegerwinkel 85° · Jarret de flèche principale 85° · Inclinazione braccio base 85° · Ângulo de pluma principal 85° · Угол подъема гл. стрелы 85°

Main boom angle 87°, 85°, 75°, 65° and 55°, capacities for intermediate boom positions are calculated by the crane control system IC-1 · Hauptauslegerwinkel 87°, 85°, 75°, 65° und 55°, Traglasten für Zwischenstellungen des Hauptauslegers werden von der Kransteuerung IC-1 berechnet · Jarret de flèche principale 87°, 85°, 75°, 65° et 55°, le système de commande de la grue IC-1 calcule les charges pour les positions intermédiaires de la flèche · Inclinazione braccio base 87°, 85°, 75°, 65° e 55°, capacità per posizioni intermedie del braccio sono calcolate dal sistema di controllo della gru IC-1 · Ângulo de pluma principal 87°, 85°, 75°, 65° y 55°, las capacidades para posiciones de pluma intermedias son calculadas por el sistema de control de grúa IC-1 · Ângulos da lança principal 87°, 85°, 75°, 65° e 55°, as capacidades para posições da lança intermediária são calculadas pelo sistema de controle da grua IC-1 · Грузоподъемность при углах подъема главной стрелы 87°, 85°, 75°, 65° и 55°, грузоподъемность в промежуточных положениях стрелы рассчитывается системой управления краном IC-1

| 165 t + 50 t | | | | | | | | 11-19 m | | | | | | | | 8,40 m | | | | | | | | 9.8 m/s | | | | | | | | 360° | | | | | | | | ISO | | | | | | | |
|--------------|-------|---------|-------|-----------|------|------|---|-------------|-------|-------|------|-----------|------|---------|---|--------|-----|-------|-------|------|------|------|------|---------|--|--|--|--|--|--|--|------|--|--|--|--|--|--|--|-----|--|--|--|--|--|--|--|
| 48 m + 60 m | | | | | | | | 48 m + 72 m | | | | | | | | | | | | | | | | | | | | | | | | | | | | | | | | | | | | | | | |
| SWSL_1 | | | | SFSL_1 | | | | SWSL_1 | | | | SFSL_1 | | | | | | | | | | | | | | | | | | | | | | | | | | | | | | | | | | | |
| 0 t | | | | 0 t-325 t | | | | 0 t | | | | 0 t-325 t | | | | | | | | | | | | | | | | | | | | | | | | | | | | | | | | | | | |
| 87°/85° | | 87°/85° | | 75° | | 65° | | 55° | | 15° | | 87°/85° | | 87°/85° | | 75° | | 65° | | 55° | | 15° | | | | | | | | | | | | | | | | | | | | | | | | | |
| m | t | t | t | t | t | t | t | m | t | t | t | t | t | t | t | t | m | t | t | t | t | t | | | | | | | | | | | | | | | | | | | | | | | | | |
| 20 | 111,0 | 137,0 | - | - | - | - | - | 23 | 90,5 | 99,5 | - | - | - | - | - | - | 24 | 87,0 | 99,5 | - | - | - | - | | | | | | | | | | | | | | | | | | | | | | | | |
| 22 | 101,0 | 136,0 | - | - | - | - | - | 24 | 87,0 | 99,5 | - | - | - | - | - | - | 26 | 80,0 | 99,0 | - | - | - | - | | | | | | | | | | | | | | | | | | | | | | | | |
| 24 | 93,0 | 137,0* | - | - | - | - | - | 26 | 80,0 | 99,0 | - | - | - | - | - | - | 28 | 74,5 | 99,0* | - | - | - | - | | | | | | | | | | | | | | | | | | | | | | | | |
| 26 | 86,0 | 137,0* | - | - | - | - | - | 28 | 74,5 | 99,0* | - | - | - | - | - | - | 30 | 69,0 | 99,0* | - | - | - | - | | | | | | | | | | | | | | | | | | | | | | | | |
| 28 | 80,0 | 137,0* | - | - | - | - | - | 30 | 69,0 | 99,0* | - | - | - | - | - | - | 33 | 62,2 | 98,2* | - | - | - | 97,5 | | | | | | | | | | | | | | | | | | | | | | | | |
| 29 | 77,0 | 136,5* | - | - | - | - | - | 33 | 62,2 | 98,2* | - | - | - | - | - | - | 34 | 60,0 | 98,0* | - | - | - | 97,3 | | | | | | | | | | | | | | | | | | | | | | | | |
| 30 | 74,0 | 136,0* | - | - | - | - | - | 34 | 60,0 | 98,0* | - | - | - | - | - | - | 38 | 53,0 | 96,5* | - | - | - | 96,5 | | | | | | | | | | | | | | | | | | | | | | | | |
| 34 | 65,0 | 134,0* | - | - | - | - | - | 42 | 47,1 | 95,0* | - | - | - | - | - | - | 46 | 42,1 | 93,0* | - | - | - | 93,5 | | | | | | | | | | | | | | | | | | | | | | | | |
| 38 | 57,5 | 132,0* | - | - | - | - | - | 46 | 42,1 | 93,0* | - | - | - | - | - | - | 47 | 41,0 | 92,5* | 87,5 | - | - | 93,0 | | | | | | | | | | | | | | | | | | | | | | | | |
| 42 | 51,0 | 129,0* | 124,0 | - | - | - | - | 47 | 41,0 | 92,5* | 87,5 | - | - | - | - | - | 50 | 37,7 | 91,0* | 87,5 | - | - | 91,5 | | | | | | | | | | | | | | | | | | | | | | | | |
| 46 | 44,7 | 123,0* | 124,0 | - | - | - | - | 50 | 37,7 | 91,0* | 87,5 | - | - | - | - | - | 54 | 33,7 | 89,5* | 87,5 | - | - | 89,5 | | | | | | | | | | | | | | | | | | | | | | | | |
| 50 | 39,5 | 107,0* | 124,0 | - | - | - | - | 54 | 33,7 | 89,5* | 87,5 | - | - | - | - | - | 58 | 30,0 | 86,5* | 87,5 | - | - | 87,0 | | | | | | | | | | | | | | | | | | | | | | | | |
| 54 | 35,2 | 93,5* | 124,0 | - | - | - | - | 58 | 30,0 | 86,5* | 87,5 | - | - | - | - | - | 62 | 26,9 | 77,0* | 87,5 | - | - | 84,5 | | | | | | | | | | | | | | | | | | | | | | | | |
| 58 | 31,5 | 81,5* | 113,0 | - | - | - | - | 62 | 26,9 | 77,0* | 87,5 | - | - | - | - | - | 65 | 24,8 | 70,2* | 87,5 | 72,5 | - | 83,0 | | | | | | | | | | | | | | | | | | | | | | | | |
| 59 | 30,7 | 78,6* | 109,6 | 106,0 | - | - | - | 65 | 24,8 | 70,2* | 87,5 | 72,5 | - | - | - | - | 66 | 24,1 | 68,0* | 87,5 | 72,5 | - | 82,5 | | | | | | | | | | | | | | | | | | | | | | | | |
| 62 | 28,5 | 70,0* | 99,5 | 106,0 | - | - | - | 66 | 24,1 | 68,0* | 87,5 | 72,5 | - | - | - | - | 70 | 21,5 | 60,0* | 81,5 | 72,5 | - | 80,0 | | | | | | | | | | | | | | | | | | | | | | | | |
| 64 | 25,9* | 63,5* | 93,2 | 105,0 | - | - | - | 70 | 21,5 | 60,0* | 81,5 | 72,5 | - | - | - | - | 74 | 19,3 | 52,0* | 72,5 | 72,5 | - | 77,6 | | | | | | | | | | | | | | | | | | | | | | | | |
| 66 | - | - | 87,0 | 104,0 | - | - | - | 74 | 19,3 | 52,0* | 72,5 | 72,5 | - | - | - | - | 76 | 17,2* | 47,5* | 68,5 | 72,5 | - | 76,5 | | | | | | | | | | | | | | | | | | | | | | | | |
| 70 | - | - | 76,0 | 96,5 | - | - | - | 76 | 17,2* | 47,5* | 68,5 | 72,5 | - | - | - | - | 78 | - | - | 64,5 | 72,5 | - | 75,0 | | | | | | | | | | | | | | | | | | | | | | | | |
| 73 | - | - | 66,5 | 92,0 | - | - | - | 78 | - | - | 64,5 | 72,5 | - | - | - | - | 82 | - | - | 56,5 | 72,5 | 62,5 | 73,0 | | | | | | | | | | | | | | | | | | | | | | | | |
| 74 | - | - | - | 90,5 | 86,0 | - | - | 82 | - | - | 56,5 | 72,5 | 62,5 | - | - | - | 84 | - | - | 52,5 | 70,8 | 62,5 | 72,0 | | | | | | | | | | | | | | | | | | | | | | | | |
| 78 | - | - | - | 80,0 | 80,5 | 80,5 | - | 84 | - | - | 52,5 | 70,8 | 62,5 | - | - | - | 86 | - | - | - | 67,5 | 62,5 | 69,5 | | | | | | | | | | | | | | | | | | | | | | | | |
| 80 | - | - | - | 74,0 | 78,2 | 77,1 | - | 86 | - | - | - | 67,5 | 62,5 | - | - | - | 90 | - | - | - | 60,0 | 62,5 | 64,5 | | | | | | | | | | | | | | | | | | | | | | | | |
| 82 | - | - | - | - | 76,0 | 73,8 | - | 90 | - | - | - | 60,0 | 62,5 | - | - | - | 92 | - | - | - | 56,0 | 62,2 | 61,1 | | | | | | | | | | | | | | | | | | | | | | | | |
| 86 | - | - | - | - | 71,5 | 66,6 | - | 94 | - | - | - | 56,0 | 62,2 | - | - | - | 98 | - | - | - | - | 58,5 | 51,5 | | | | | | | | | | | | | | | | | | | | | | | | |
| 88 | - | - | - | - | 69,5 | 62,8 | - | 98 | - | - | - | - | 58,5 | - | - | - | 99 | - | - | - | - | 58,0 | 50,1 | | | | | | | | | | | | | | | | | | | | | | | | |
| 90 | - | - | - | - | - | 59,0 | - | 102 | - | - | - | - | - | - | - | - | 106 | - | - | - | - | - | 47,3 | | | | | | | | | | | | | | | | | | | | | | | | |
| 94 | - | - | - | - | - | 53,1 | - | 106 | - | - | - | - | - | - | - | - | 110 | - | - | - | - | - | 41,8 | | | | | | | | | | | | | | | | | | | | | | | | |
| 98 | - | - | - | - | - | 47,0 | - | 110 | - | - | - | - | - | - | - | - | 113 | - | - | - | - | - | 36,1 | | | | | | | | | | | | | | | | | | | | | | | | |
| 102 | - | - | - | - | - | 41,9 | - | 113 | - | - | - | - | - | - | - | - | | | | | | | 33,5 | | | | | | | | | | | | | | | | | | | | | | | | |

* Main boom angle 85° · Hauptauslegerwinkel 85° · Jarret de flèche principale 85° · Inclinazione braccio base 85° · Ángulo de pluma principal 85° · Ángulo da lança principal 85° · Угол подъема гл. стрелы 85°

Main boom angle 87°, 85°, 75°, 65° and 55°, capacities for intermediate boom positions are calculated by the crane control system IC-1 · Hauptauslegerwinkel 87°, 85°, 75°, 65° und 55°, Traglasten für Zwischenstellungen des Hauptauslegers werden von der Kransteuerung IC-1 berechnet · Jarret de flèche principale 87°, 85°, 75°, 65° et 55°, le système de commande de la grue IC-1 calcule les charges pour les positions intermédiaires de la flèche · Inclinazione braccio base 87°, 85°, 75°, 65° e 55°, capacità per posizioni intermedie del braccio sono calcolate dal sistema di controllo della gru IC-1 · Ángulo de pluma principal 87°, 85°, 75°, 65° y 55°, las capacidades para posiciones de pluma intermedias son calculadas por el sistema de control de grúa IC-1 · Ángulos da lança principal 87°, 85°, 75°, 65° e 55°; as capacidades para posições da lança intermediária são calculadas pelo sistema de controle da grua IC-1 · Грузоподъемность при углах подъема главной стрелы 87°, 85°, 75°, 65° и 55°, грузоподъемность в промежуточных положениях стрелы рассчитывается системой управления краном IC-1

| 165 t + 50 t | | 11-19 m | | 8,40 m | | 9.8 m/s | | 360° | | ISO | | | | | |
|--------------|-------|-----------|------|--------|-----|-------------|------|-----------|------|---------|------|------|------|-----|------|
| 48 m + 84 m | | | | | | 48 m + 90 m | | | | | | | | | |
| SWSL_1 | | | | | | SWSL_1 | | | | | | | | | |
| SFSL_1 | | | | | | SFSL_1 | | | | | | | | | |
| 0 t | | 0 t-325 t | | | | 0 t | | 0 t-325 t | | | | | | | |
| 87°/85° | | 87°/85° | 75° | 65° | 55° | 15° | | 87°/85° | | 87°/85° | 75° | 65° | 55° | 15° | |
| m | t | t | t | t | t | t | t | t | t | t | t | t | t | t | t |
| 25 | 70,5 | 72,0 | - | - | - | - | - | 28 | 51,0 | 52,0 | - | - | - | - | - |
| 26 | 70,5 | 71,5 | - | - | - | - | - | 30 | 50,5 | 51,5 | - | - | - | - | - |
| 28 | 69,0 | 71,0 | - | - | - | - | - | 34 | 49,8 | 50,5* | - | - | - | - | - |
| 30 | 64,0 | 70,5* | - | - | - | - | - | 38 | 44,7 | 50,0* | - | - | - | - | - |
| 34 | 55,5 | 70,0* | - | - | - | - | - | 41 | 40,5 | 49,4* | - | - | - | - | 49,2 |
| 37 | 50,4 | 69,2* | - | - | - | - | 68,5 | 42 | 39,2 | 49,2* | - | - | - | - | 49,0 |
| 38 | 48,8 | 69,0* | - | - | - | - | 68,3 | 46 | 34,5 | 48,3* | - | - | - | - | 48,2 |
| 42 | 43,1 | 67,5* | - | - | - | - | 67,5 | 50 | 30,5 | 47,4* | - | - | - | - | 47,2 |
| 46 | 38,2 | 66,5* | - | - | - | - | 66,1 | 54 | 27,0 | 46,5* | - | - | - | - | 46,1 |
| 50 | 34,0 | 65,5* | - | - | - | - | 64,8 | 57 | 24,6 | 45,8* | 42,7 | - | - | - | 45,2 |
| 52 | 32,2 | 64,7* | 61,0 | - | - | - | 64,1 | 58 | 23,9 | 45,6* | 42,7 | - | - | - | 44,9 |
| 54 | 30,4 | 64,0* | 61,0 | - | - | - | 63,5 | 62 | 21,2 | 44,7* | 42,6 | - | - | - | 43,6 |
| 58 | 27,2 | 63,0* | 61,0 | - | - | - | 61,8 | 66 | 18,8 | 43,8* | 42,4 | - | - | - | 42,3 |
| 62 | 24,4 | 62,0* | 61,0 | - | - | - | 60,1 | 70 | 16,6 | 42,9* | 42,1 | - | - | - | 41,1 |
| 66 | 21,9 | 61,0* | 60,5 | - | - | - | 58,5 | 74 | 14,6 | 42,1* | 41,8 | - | - | - | 39,9 |
| 70 | 19,7 | 60,0* | 60,5 | - | - | - | 57,1 | 78 | 12,9 | 41,3* | 41,4 | - | - | - | 38,7 |
| 72 | 18,5 | 58,5* | 60,2 | 50,0 | - | - | 56,5 | 79 | 12,5 | 41,1* | 41,3 | 34,1 | - | - | 38,4 |
| 74 | 17,4 | 57,0* | 60,0 | 50,0 | - | - | 55,5 | 82 | 11,3 | 40,6* | 41,1 | 34,1 | - | - | 37,5 |
| 78 | 15,4 | 50,5* | 60,0 | 50,0 | - | - | 54,0 | 86 | 9,8 | 39,8* | 40,8 | 34,1 | - | - | 36,3 |
| 82 | 13,6 | 44,9* | 59,5 | 50,0 | - | - | 52,3 | 90 | 8,5 | 37,7* | 40,6 | 34,1 | - | - | 35,3 |
| 86 | 12,0 | 38,8* | 54,5 | 50,0 | - | - | 50,9 | 94 | 7,2 | 33,1* | 40,3 | 34,1 | - | - | 34,2 |
| 87 | 10,6* | 37,1* | 53,0 | 50,0 | - | - | 50,6 | 97 | 6,3 | 29,6* | 40,1 | 34,1 | - | - | 33,4 |
| 90 | - | - | 48,8 | 50,0 | - | - | 49,8 | 98 | 5,1* | 28,4* | 40,1 | 34,1 | - | - | 33,2 |
| 91 | - | - | 47,3 | 50,0 | - | - | 49,4 | 99 | 4,8* | 27,0* | 39,2 | 34,1 | 28,1 | - | 32,9 |
| 94 | - | - | 42,9 | 50,0 | - | - | 48,5 | 102 | - | - | 36,5 | 34,1 | 28,1 | - | 32,2 |
| 96 | - | - | 39,6 | 50,0 | - | - | 47,9 | 106 | - | - | 31,9 | 34,1 | 28,1 | - | 31,3 |
| 98 | - | - | - | 50,0 | - | - | 47,3 | 107 | - | - | 30,7 | 34,1 | 28,1 | - | 31,1 |
| 102 | - | - | - | 45,9 | - | - | 46,1 | 110 | - | - | - | 34,1 | 28,1 | - | 30,5 |
| 104 | - | - | - | 42,8 | - | - | 44,8 | 114 | - | - | - | 34,1 | 28,1 | - | 29,8 |
| 106 | - | - | - | - | - | - | 43,6 | 115 | - | - | - | 33,4 | 28,1 | - | 29,6 |
| 110 | - | - | - | - | - | - | 42,6 | 118 | - | - | - | - | 28,1 | - | 29,1 |
| 111 | - | - | - | - | - | - | 39,4 | 122 | - | - | - | - | 28,1 | - | 28,3 |
| 114 | - | - | - | - | - | - | 36,9 | 123 | - | - | - | - | 28,1 | - | 28,1 |
| 118 | - | - | - | - | - | - | 31,9 | 126 | - | - | - | - | - | - | 27,5 |
| 122 | - | - | - | - | - | - | 27,2 | 130 | - | - | - | - | - | - | 23,3 |
| 125 | - | - | - | - | - | - | 25,1 | 134 | - | - | - | - | - | - | 19,8 |
| | | | | | | | | 137 | - | - | - | - | - | - | 17,4 |

* Main boom angle 85° · Hauptauslegerwinkel 85° · Jarret de flèche principale 85° · Inclinazione braccio base 85° · Ángulo de pluma principal 85° · Ángulo da lança principal 85° · Угол подъема гл. стрелы 85°

Main boom angle 87°, 85°, 75°, 65° and 55°, capacities for intermediate boom positions are calculated by the crane control system IC-1 · Hauptauslegerwinkel 87°, 85°, 75°, 65° und 55°, Traglasten für Zwischenstellungen des Hauptauslegers werden von der Kransteuerung IC-1 berechnet · Jarret de flèche principale 87°, 85°, 75°, 65° et 55°, le système de commande de la grue IC-1 calcule les charges pour les positions intermédiaires de la flèche · Inclinazione braccio base 87°, 85°, 75°, 65° e 55°, capacità per posizioni intermedie del braccio sono calcolate dal sistema di controllo della gru IC-1 · Ángulo de pluma principal 87°, 85°, 75°, 65° y 55°, las capacidades para posiciones de pluma intermedias son calculadas por el sistema de control de grúa IC-1 · Ángulos da lança principal 87°, 85°, 75°, 65° e 55°; as capacidades para posições da lança intermediária são calculadas pelo sistema de controle da grua IC-1 · Грузоподъемность при углах подъема главной стрелы 87°, 85°, 75°, 65° и 55°, грузоподъемность в промежуточных положениях стрелы рассчитывается системой управления краном IC-1

| 165 t + 50 t | | 11-19 m | | 8,40 m | | 9.8 m/s | | 360° | | ISO | |
|-----------------|-------|---------|-------|--------|-------|-----------------|---|------|---|-----|-------|
| 54 m + 24 m | | | | | | 54 m + 36 m | | | | | |
| SWSL_1 | | | | | | SWSL_1 | | | | | |
| 0 t - 0 t-325 t | | | | | | 0 t - 0 t-325 t | | | | | |
| 87°/85° | | 87°/85° | | 75° | | 65° | | 55° | | 15° | |
| m | t | t | t | t | t | t | t | t | t | t | t |
| 12 | 212,0 | 332,0 | - | - | - | - | - | - | - | - | - |
| 14 | 185,0 | 323,0 | - | - | - | - | - | - | - | - | - |
| 16 | 164,0 | 337,0* | - | - | - | - | - | - | - | - | - |
| 17 | 155,0 | 333,0* | - | - | - | - | - | - | - | - | - |
| 18 | 147,0 | 329,0* | - | - | - | - | - | - | - | - | - |
| 20 | 133,0 | 316,0* | - | - | - | - | - | - | - | - | - |
| 22 | 121,0 | 304,0* | - | - | - | - | - | - | - | - | - |
| 24 | 112,0 | 287,0* | - | - | - | - | - | - | - | - | - |
| 26 | 103,0 | 274,0* | - | - | - | - | - | - | - | - | - |
| 28 | 93,0 | 236,0* | - | - | - | - | - | - | - | - | - |
| 29 | 86,5* | 217,0* | 280,0 | - | - | - | - | - | - | - | - |
| 30 | 82,5* | 198,0* | 271,0 | - | - | - | - | - | - | - | - |
| 34 | - | - | 238,0 | - | - | - | - | - | - | - | - |
| 38 | - | - | 212,0 | - | - | - | - | - | - | - | - |
| 39 | - | - | 207,0 | - | - | - | - | - | - | - | - |
| 42 | - | - | - | 183,0 | - | - | - | - | - | - | - |
| 46 | - | - | - | 164,0 | - | - | - | - | - | - | - |
| 48 | - | - | - | 156,0 | - | - | - | - | - | - | - |
| 50 | - | - | - | - | - | - | - | - | - | - | - |
| 53 | - | - | - | - | - | 134,0 | - | - | - | - | - |
| 54 | - | - | - | - | - | 131,0 | - | - | - | - | - |
| 56 | - | - | - | - | - | 125,0 | - | - | - | - | - |
| 58 | - | - | - | - | - | - | - | - | - | - | - |
| 62 | - | - | - | - | - | - | - | - | - | - | - |
| 66 | - | - | - | - | - | - | - | - | - | - | - |
| 70 | - | - | - | - | - | - | - | - | - | - | - |
| 72 | - | - | - | - | - | - | - | - | - | - | - |
| 15 | 160,0 | 238,0 | - | - | - | - | - | - | - | - | - |
| 16 | 151,0 | 237,0 | - | - | - | - | - | - | - | - | - |
| 18 | 136,0 | 244,0* | - | - | - | - | - | - | - | - | - |
| 20 | 123,0 | 241,0* | - | - | - | - | - | - | - | - | - |
| 21 | 118,0 | 239,0* | - | - | - | - | - | - | - | - | 234,0 |
| 22 | 113,0 | 237,0* | - | - | - | - | - | - | - | - | 234,0 |
| 24 | 104,0 | 233,0* | - | - | - | - | - | - | - | - | 234,0 |
| 26 | 96,0 | 228,0* | - | - | - | - | - | - | - | - | 234,0 |
| 28 | 89,0 | 222,0* | - | - | - | - | - | - | - | - | 232,0 |
| 30 | 83,5 | 215,0* | - | - | - | - | - | - | - | - | 231,0 |
| 33 | 74,1 | 195,5* | 232,0 | - | - | - | - | - | - | - | 225,0 |
| 34 | 71,0 | 189,0* | 232,0 | - | - | - | - | - | - | - | 224,0 |
| 38 | 61,0 | 154,0* | 210,0 | - | - | - | - | - | - | - | 209,6 |
| 40 | 57,0 | 136,5* | 199,5 | - | - | - | - | - | - | - | 197,3 |
| 42 | 51,5* | 119,0* | 189,0 | - | - | - | - | - | - | - | 185,0 |
| 46 | - | - | 170,0 | - | - | - | - | - | - | - | 165,0 |
| 48 | - | - | 155,0 | 154,0 | - | - | - | - | - | - | 155,0 |
| 50 | - | - | 140,0 | 147,0 | - | - | - | - | - | - | 147,3 |
| 51 | - | - | 132,0 | 143,7 | - | - | - | - | - | - | 143,5 |
| 54 | - | - | - | 134,0 | - | - | - | - | - | - | 132,0 |
| 58 | - | - | - | 123,0 | - | - | - | - | - | - | 120,0 |
| 60 | - | - | - | 119,0 | - | - | - | - | - | - | 114,0 |
| 61 | - | - | - | - | 111,0 | - | - | - | - | - | 111,5 |
| 62 | - | - | - | - | 109,0 | - | - | - | - | - | 109,1 |
| 66 | - | - | - | - | 101,0 | - | - | - | - | - | 99,5 |
| 68 | - | - | - | - | 98,0 | - | - | - | - | - | 95,5 |
| 70 | - | - | - | - | - | - | - | - | - | - | 91,5 |
| 74 | - | - | - | - | - | - | - | - | - | - | 82,6 |
| 78 | - | - | - | - | - | - | - | - | - | - | 72,0 |
| 82 | - | - | - | - | - | - | - | - | - | - | 63,3 |
| 84 | - | - | - | - | - | - | - | - | - | - | 59,5 |

* Main boom angle 85° · Hauptauslegerwinkel 85° · Jarret de flèche principale 85° · Inclinação braccio base 85° · Ángulo de pluma principal 85° · Ângulo da lança principal 85° · Угол подъема гл. стрелы 85°

Main boom angle 87°, 85°, 75°, 65° and 55°, capacities for intermediate boom positions are calculated by the crane control system IC-1 · Hauptauslegerwinkel 87°, 85°, 75°, 65° und 55°, Traglasten für Zwischenstellungen des Hauptauslegers werden von der Kransteuerung IC-1 berechnet · Jarret de flèche principale 87°, 85°, 75°, 65° et 55°, le système de commande de la grue IC-1 calcule les charges pour les positions intermédiaires de la flèche · Inclinação braccio base 87°, 85°, 75°, 65° e 55°, capacità per posizioni intermedie del braccio sono calcolate dal sistema di controllo della gru IC-1 · Ángulo de pluma principal 87°, 85°, 75°, 65° y 55°, las capacidades para posiciones de pluma intermedias son calculadas por el sistema de control de grúa IC-1 · Ângulos da lança principal 87°, 85°, 75°, 65° e 55°; as capacidades para posições da lança intermediária são calculadas pelo sistema de controle da grua IC-1 · Грузоподъемность при углах подъема главной стрелы 87°, 85°, 75°, 65° и 55°, грузоподъемность в промежуточных положениях стрелы рассчитывается системой управления краном IC-1

| 165 t + 50 t | | | | | | | | 11-19 m | | 8,40 m | | 9.8 m/s | | 360° | | ISO | | | |
|--------------|-------|--------|-------|-------|------|---|-------|-----------|-------|--------|-------|---------|------|------|---|-------|---|--|--|
| 54 m + 48 m | | | | | | | | | | | | | | | | | | | |
| SWSL_1 | | | | | | | | SFSL_1 | | | | | | | | | | | |
| 0 t | | | | | | | | 0 t-325 t | | | | | | | | | | | |
| 87°/85° | | | | | | | | 87°/85° | | 75° | | 65° | | 55° | | 15° | | | |
| m | t | t | t | t | t | t | t | m | t | t | t | t | t | t | t | t | t | | |
| 17 | 133,0 | 174,0 | - | - | - | - | - | 20 | 107,0 | 128,0 | - | - | - | - | - | - | - | | |
| 18 | 126,0 | 173,0 | - | - | - | - | - | 22 | 98,0 | 127,0 | - | - | - | - | - | - | - | | |
| 20 | 115,0 | 171,0 | - | - | - | - | - | 24 | 90,0 | 128,0* | - | - | - | - | - | - | - | | |
| 22 | 105,0 | 175,0* | - | - | - | - | - | 26 | 83,0 | 128,0* | - | - | - | - | - | - | - | | |
| 24 | 96,5 | 174,0* | - | - | - | - | - | 28 | 77,0 | 127,0* | - | - | - | - | - | - | - | | |
| 25 | 92,7 | 173,0* | - | - | - | - | 170,0 | 29 | 74,5 | 127,0* | - | - | - | - | - | 125,0 | - | | |
| 26 | 89,0 | 172,0* | - | - | - | - | 170,0 | 30 | 72,0 | 127,0* | - | - | - | - | - | 125,0 | - | | |
| 28 | 83,0 | 171,0* | - | - | - | - | 170,0 | 34 | 63,0 | 125,0* | - | - | - | - | - | 125,0 | - | | |
| 30 | 77,0 | 168,0* | - | - | - | - | 170,0 | 38 | 55,5 | 122,0* | - | - | - | - | - | 124,6 | - | | |
| 34 | 67,5 | 163,0* | - | - | - | - | 169,0 | 42 | 49,6 | 119,0* | - | - | - | - | - | 124,0 | - | | |
| 38 | 59,5 | 158,0* | 164,0 | - | - | - | 167,3 | 43 | 48,3 | 118,2* | 116,0 | - | - | - | - | 122,6 | - | | |
| 42 | 52,0 | 143,0* | 163,0 | - | - | - | 166,0 | 46 | 44,4 | 116,0* | 116,0 | - | - | - | - | 121,6 | - | | |
| 46 | 45,9 | 122,0* | 163,0 | - | - | - | 159,0 | 50 | 39,2 | 110,0* | 116,0 | - | - | - | - | 118,6 | - | | |
| 50 | 40,8 | 104,0* | 152,0 | - | - | - | 148,3 | 54 | 34,9 | 96,5* | 116,0 | - | - | - | - | 116,0 | - | | |
| 51 | 39,7 | 99,1* | 147,5 | - | - | - | 144,5 | 58 | 31,2 | 84,0* | 116,0 | - | - | - | - | 112,6 | - | | |
| 53 | 36,0* | 89,5* | 138,5 | - | - | - | 136,8 | 61 | 28,9 | 75,0* | 107,7 | 99,5 | - | - | - | 109,3 | - | | |
| 54 | - | - | 134,0 | - | - | - | 133,0 | 62 | 28,2 | 72,0* | 105,0 | 99,5 | - | - | - | 107,6 | - | | |
| 55 | - | - | 129,2 | 129,0 | - | - | 130,0 | 63 | 27,5 | 68,8* | 101,8 | 99,0 | - | - | - | 106,0 | - | | |
| 58 | - | - | 115,0 | 121,0 | - | - | 121,0 | 65 | 24,8* | 62,5* | 95,6 | 99,0 | - | - | - | 102,6 | - | | |
| 62 | - | - | 97,5 | 112,0 | - | - | 110,0 | 66 | - | - | 92,5 | 99,0 | - | - | - | 101,0 | - | | |
| 66 | - | - | - | 104,0 | - | - | 100,0 | 70 | - | - | 81,0 | 94,5 | - | - | - | 93,0 | - | | |
| 70 | - | - | - | 97,0 | 92,0 | - | 92,3 | 74 | - | - | 69,0 | 88,5 | - | - | - | 85,8 | - | | |
| 71 | - | - | - | 95,0 | 90,5 | - | 90,4 | 78 | - | - | - | 83,0 | 78,5 | - | - | 79,0 | - | | |
| 74 | - | - | - | - | 86,0 | - | 85,1 | 82 | - | - | - | 76,5 | 73,5 | - | - | 73,3 | - | | |
| 78 | - | - | - | - | 80,5 | - | 78,5 | 83 | - | - | - | 73,5 | 72,5 | - | - | 71,9 | - | | |
| 80 | - | - | - | - | 78,5 | - | 75,1 | 86 | - | - | - | - | 69,5 | - | - | 68,0 | - | | |
| 82 | - | - | - | - | - | - | 71,8 | 90 | - | - | - | - | 65,5 | - | - | 63,0 | - | | |
| 86 | - | - | - | - | - | - | 64,1 | 91 | - | - | - | - | 64,5 | - | - | 61,3 | - | | |
| 90 | - | - | - | - | - | - | 56,5 | 94 | - | - | - | - | - | - | - | 56,3 | - | | |
| 94 | - | - | - | - | - | - | 49,8 | 98 | - | - | - | - | - | - | - | 49,6 | - | | |
| 95 | - | - | - | - | - | - | 48,2 | 102 | - | - | - | - | - | - | - | 45,3 | - | | |
| | | | | | | | | 106 | - | - | - | - | - | - | - | 38,5 | - | | |
| | | | | | | | | 107 | - | - | - | - | - | - | - | 36,9 | - | | |

0 t 65 t 125 t 165 t 205 t 245 t 285 t 325 t

* Main boom angle 85° · Hauptauslegerwinkel 85° · Jarret de flèche principale 85° · Inclinazione braccio base 85° · Ángulo de pluma principal 85° · Ângulo da lança principal 85° · Угол подъема гл. стрелы 85°

Main boom angle 87°, 85°, 75°, 65° and 55°, capacities for intermediate boom positions are calculated by the crane control system IC-1 · Hauptauslegerwinkel 87°, 85°, 75°, 65° und 55°, Traglasten für Zwischenstellungen des Hauptauslegers werden von der Kransteuerung IC-1 berechnet · Jarret de flèche principale 87°, 85°, 75°, 65° et 55°, le système de commande de la grue IC-1 calcule les charges pour les positions intermédiaires de la flèche · Inclinazione braccio base 87°, 85°, 75°, 65° e 55°, capacità per posizioni intermedie del braccio sono calcolate dal sistema di controllo della gru IC-1 · Ángulo de pluma principal 87°, 85°, 75°, 65° y 55°, las capacidades para posiciones de pluma intermedias son calculadas por el sistema de control de grúa IC-1 · Ângulos da lança principal 87°, 85°, 75°, 65° e 55°; as capacidades para posições da lança intermediária são calculadas pelo sistema de controle da grua IC-1 · Грузоподъемность при углах подъема главной стрелы 87°, 85°, 75°, 65° и 55°, грузоподъемность в промежуточных положениях стрелы рассчитывается системой управления краном IC-1

| 165 t + 50 t | | 11-19 m | | 8,40 m | | 9.8 m/s | | 360° | | ISO | |
|--------------|-------|---------|------|--------|------|-------------|---|------|---|------|---|
| 54 m + 72 m | | | | | | 54 m + 84 m | | | | | |
| SWSL_1 | | | | | | SWSL_1 | | | | | |
| 0 t | | | | | | 0 t-325 t | | | | | |
| 87°/85° | | 87°/85° | | 75° | | 65° | | 55° | | 15° | |
| m | t | t | t | t | t | t | t | t | t | t | t |
| 23 | 87,5 | 94,0 | - | - | - | - | - | - | - | - | - |
| 24 | 84,0 | 94,0 | - | - | - | - | - | - | - | - | - |
| 26 | 77,5 | 93,5 | - | - | - | - | - | - | - | - | - |
| 28 | 71,5 | 93,5* | - | - | - | - | - | - | - | - | - |
| 30 | 66,5 | 93,5* | - | - | - | - | - | - | - | - | - |
| 33 | 60,1 | 92,7* | - | - | - | - | - | - | - | 92,0 | - |
| 34 | 58,0 | 92,5* | - | - | - | - | - | - | - | 92,0 | - |
| 38 | 51,0 | 91,5* | - | - | - | - | - | - | - | 91,6 | - |
| 42 | 45,6 | 90,0* | - | - | - | - | - | - | - | 91,0 | - |
| 46 | 40,7 | 88,5* | - | - | - | - | - | - | - | 89,3 | - |
| 48 | 38,6 | 87,7* | 82,5 | - | - | - | - | - | - | 88,5 | - |
| 50 | 36,5 | 87,0* | 82,5 | - | - | - | - | - | - | 87,5 | - |
| 54 | 32,8 | 85,0* | 82,5 | - | - | - | - | - | - | 85,5 | - |
| 58 | 29,7 | 83,5* | 82,5 | - | - | - | - | - | - | 83,5 | - |
| 62 | 26,6 | 78,5* | 82,5 | - | - | - | - | - | - | 81,0 | - |
| 66 | 23,8 | 69,5* | 82,5 | - | - | - | - | - | - | 79,0 | - |
| 68 | 22,5 | 65,5* | 82,5 | 68,5 | - | - | - | - | - | 78,0 | - |
| 70 | 21,2 | 61,5* | 82,5 | 68,5 | - | - | - | - | - | 77,0 | - |
| 74 | 19,1 | 53,0* | 76,0 | 68,5 | - | - | - | - | - | 74,9 | - |
| 76 | 16,7* | 49,1* | 72,0 | 68,5 | - | - | - | - | - | 73,7 | - |
| 78 | - | - | 68,0 | 68,5 | - | - | - | - | - | 72,5 | - |
| 82 | - | - | 60,0 | 68,5 | - | - | - | - | - | 70,5 | - |
| 86 | - | - | 51,5 | 68,5 | 59,0 | - | - | - | - | 67,3 | - |
| 90 | - | - | - | 65,0 | 59,0 | 63,0 | - | - | - | 63,0 | - |
| 94 | - | - | - | 57,5 | 59,0 | 58,6 | - | - | - | 58,6 | - |
| 95 | - | - | - | 55,5 | 58,3 | 57,5 | - | - | - | 57,5 | - |
| 98 | - | - | - | - | 56,5 | 54,1 | - | - | - | 54,1 | - |
| 102 | - | - | - | - | 53,5 | 49,0 | - | - | - | 49,0 | - |
| 103 | - | - | - | - | 47,6 | 47,6 | - | - | - | 47,6 | - |
| 106 | - | - | - | - | - | 43,4 | - | - | - | 43,4 | - |
| 110 | - | - | - | - | - | 38,5 | - | - | - | 38,5 | - |
| 114 | - | - | - | - | - | 34,5 | - | - | - | 34,5 | - |
| 118 | - | - | - | - | - | 29,0 | - | - | - | 29,0 | - |
| 119 | - | - | - | - | - | 27,9 | - | - | - | 27,9 | - |

| 0 t | | 65 t | 125 t | 165 t | 205 t | 245 t | 285 t | 325 t |
|-----|--|------|-------|-------|-------|-------|-------|-------|
|-----|--|------|-------|-------|-------|-------|-------|-------|

* Main boom angle 85° · Hauptauslegerwinkel 85° · Jarret de flèche principale 85° · Inclinação braccio base 85° · Ángulo de pluma principal 85° · Ángulo da lança principal 85° · Угол подъема гл. стрелы 85°

Main boom angle 87°, 85°, 75°, 65° and 55°, capacities for intermediate boom positions are calculated by the crane control system IC-1 · Hauptauslegerwinkel 87°, 85°, 75°, 65° und 55°, Traglasten für Zwischenstellungen des Hauptauslegers werden von der Kransteuerung IC-1 berechnet · Jarret de flèche principale 87°, 85°, 75°, 65° et 55°, le système de commande de la grue IC-1 calcule les charges pour les positions intermédiaires de la flèche · Inclinação braccio base 87°, 85°, 75°, 65° e 55°, capacità per posizioni intermedie del braccio sono calcolate dal sistema di controllo della gru IC-1 · Ángulo de pluma principal 87°, 85°, 75°, 65° y 55°, las capacidades para posiciones de pluma intermedias son calculadas por el sistema de control de grúa IC-1 · Ângulos da lança principal 87°, 85°, 75°, 65° e 55°; as capacidades para posições da lança intermediária são calculadas pelo sistema de controle da grua IC-1 · Грузоподъемность при углах подъема главной стрелы 87°, 85°, 75°, 65° и 55°, грузоподъемность в промежуточных положениях стрелы рассчитывается системой управления краном IC-1

| 165 t + 50 t | | | | | | | | 11-19 m | | | | | | | | 8,40 m | | | | | | | | 9.8 m/s | | | | | | | | 360° | | | | | | | | ISO | | | | | | | | | | | | | | | | | | | | | | | | | | | | | | | | | | | | | | | | | | | | | | | | | | | | | | | |
|--------------|------|-------|------|------|------|------|---|-----------|-------|--------|-------|-------|---|---|----|--------|-------|--------|-------|---|---|---|---|-------------|---|---|---|---|---|---|---|--------|---|---|---|---|---|---|---|-----------|--|--|--|--|--|--|--|---------|--|--|--|--|--|--|--|---------|--|--|--|--|--|--|--|-----|--|--|--|--|--|--|--|-----|--|--|--|--|--|--|--|-----|--|--|--|--|--|--|--|-----|--|--|--|--|--|--|--|
| 54 m + 96 m | | | | | | | | SWSL_1 | | | | | | | | SFSL_1 | | | | | | | | 60 m + 24 m | | | | | | | | SWSL_1 | | | | | | | | SFSL_1 | | | | | | | | | | | | | | | | | | | | | | | | | | | | | | | | | | | | | | | | | | | | | | | | | | | | | | | |
| 0 t | | | | | | | | 0 t-325 t | | | | | | | | 0 t | | | | | | | | 0 t-325 t | | | | | | | | 0 t | | | | | | | | 0 t-325 t | | | | | | | | | | | | | | | | | | | | | | | | | | | | | | | | | | | | | | | | | | | | | | | | | | | | | | | |
| 87°/85° | | | | | | | | 87°/85° | | | | | | | | 75° | | | | | | | | 65° | | | | | | | | 55° | | | | | | | | 15° | | | | | | | | 87°/85° | | | | | | | | 87°/85° | | | | | | | | 75° | | | | | | | | 65° | | | | | | | | 55° | | | | | | | | 15° | | | | | | | |
| m | t | t | t | t | t | t | t | m | t | t | t | t | t | t | t | m | t | t | t | t | t | t | t | m | t | t | t | t | t | t | t | m | t | t | t | t | t | t | t | | | | | | | | | | | | | | | | | | | | | | | | | | | | | | | | | | | | | | | | | | | | | | | | | | | | | | | | |
| 28 | 49,0 | 50,0 | - | - | - | - | - | 12 | - | 299,0 | - | - | - | - | - | 13 | 189,0 | 296,0 | - | - | - | - | - | - | - | - | - | - | - | - | - | - | | | | | | | | | | | | | | | | | | | | | | | | | | | | | | | | | | | | | | | | | | | | | | | | | | | | | | | | | | | | | | | |
| 30 | 48,6 | 49,6 | - | - | - | - | - | 13 | 189,0 | 296,0 | - | - | - | - | - | 14 | 177,0 | 292,0 | - | - | - | - | - | - | - | - | - | - | - | - | - | - | | | | | | | | | | | | | | | | | | | | | | | | | | | | | | | | | | | | | | | | | | | | | | | | | | | | | | | | | | | | | | | |
| 34 | 47,7 | 48,8* | - | - | - | - | - | 14 | 177,0 | 292,0 | - | - | - | - | - | 16 | 157,0 | 304,0* | - | - | - | - | - | - | - | - | - | - | - | - | - | - | | | | | | | | | | | | | | | | | | | | | | | | | | | | | | | | | | | | | | | | | | | | | | | | | | | | | | | | | | | | | | | |
| 38 | 43,0 | 48,1* | - | - | - | - | - | 16 | 157,0 | 304,0* | - | - | - | - | - | 17 | 149,0 | 301,0* | - | - | - | - | - | - | - | - | - | - | - | - | - | - | | | | | | | | | | | | | | | | | | | | | | | | | | | | | | | | | | | | | | | | | | | | | | | | | | | | | | | | | | | | | | | |
| 41 | 38,9 | 47,5* | - | - | - | - | - | 17 | 149,0 | 301,0* | - | - | - | - | - | 18 | 141,0 | 297,0* | - | - | - | - | - | - | - | - | - | - | - | - | - | - | | | | | | | | | | | | | | | | | | | | | | | | | | | | | | | | | | | | | | | | | | | | | | | | | | | | | | | | | | | | | | | |
| 42 | 37,6 | 47,3* | - | - | - | - | - | 18 | 141,0 | 297,0* | - | - | - | - | - | 20 | 128,0 | 289,0* | - | - | - | - | - | - | - | - | - | - | - | - | - | - | | | | | | | | | | | | | | | | | | | | | | | | | | | | | | | | | | | | | | | | | | | | | | | | | | | | | | | | | | | | | | | |
| 46 | 33,1 | 46,5* | - | - | - | - | - | 20 | 128,0 | 289,0* | - | - | - | - | - | 22 | 117,0 | 280,0* | - | - | - | - | - | - | - | - | - | - | - | - | - | - | | | | | | | | | | | | | | | | | | | | | | | | | | | | | | | | | | | | | | | | | | | | | | | | | | | | | | | | | | | | | | | |
| 50 | 29,2 | 45,7* | - | - | - | - | - | 22 | 117,0 | 280,0* | - | - | - | - | - | 24 | 108,0 | 266,0* | - | - | - | - | - | - | - | - | - | - | - | - | - | - | | | | | | | | | | | | | | | | | | | | | | | | | | | | | | | | | | | | | | | | | | | | | | | | | | | | | | | | | | | | | | | |
| 54 | 25,8 | 44,9* | - | - | - | - | - | 24 | 108,0 | 266,0* | - | - | - | - | - | 26 | 100,0 | 255,0* | - | - | - | - | - | - | - | - | - | - | - | - | - | - | | | | | | | | | | | | | | | | | | | | | | | | | | | | | | | | | | | | | | | | | | | | | | | | | | | | | | | | | | | | | | | |
| 58 | 22,8 | 44,0* | 40,7 | - | - | - | - | 26 | 100,0 | 255,0* | - | - | - | - | - | 28 | 93,0 | 242,0* | - | - | - | - | - | - | - | - | - | - | - | - | - | - | | | | | | | | | | | | | | | | | | | | | | | | | | | | | | | | | | | | | | | | | | | | | | | | | | | | | | | | | | | | | | | |
| 62 | 20,2 | 43,2* | 40,7 | - | - | - | - | 28 | 93,0 | 242,0* | - | - | - | - | - | 30 | 82,0* | 204,0* | 268,0 | - | - | - | - | - | - | - | - | - | - | - | - | - | | | | | | | | | | | | | | | | | | | | | | | | | | | | | | | | | | | | | | | | | | | | | | | | | | | | | | | | | | | | | | | |
| 66 | 17,8 | 42,3* | 40,7 | - | - | - | - | 30 | 82,0* | 204,0* | 268,0 | - | - | - | - | 34 | - | - | 235,0 | - | - | - | - | - | - | - | - | - | - | - | - | - | | | | | | | | | | | | | | | | | | | | | | | | | | | | | | | | | | | | | | | | | | | | | | | | | | | | | | | | | | | | | | | |
| 70 | 15,7 | 41,5* | 40,6 | - | - | - | - | 34 | - | - | 235,0 | - | - | - | 38 | - | - | 210,0 | - | - | - | - | - | - | - | - | - | - | - | - | - | - | | | | | | | | | | | | | | | | | | | | | | | | | | | | | | | | | | | | | | | | | | | | | | | | | | | | | | | | | | | | | | | |
| 74 | 13,8 | 40,7* | 40,4 | - | - | - | - | 38 | - | - | 210,0 | - | - | - | 41 | - | - | 194,0 | - | - | - | - | - | - | - | - | - | - | - | - | - | - | | | | | | | | | | | | | | | | | | | | | | | | | | | | | | | | | | | | | | | | | | | | | | | | | | | | | | | | | | | | | | | |
| 78 | 12,1 | 40,0* | 40,1 | - | - | - | - | 41 | - | - | 194,0 | - | - | - | 42 | - | - | - | - | - | - | - | - | - | - | - | - | - | - | - | - | - | | | | | | | | | | | | | | | | | | | | | | | | | | | | | | | | | | | | | | | | | | | | | | | | | | | | | | | | | | | | | | | |
| 82 | 10,6 | 39,3* | 39,9 | 32,2 | - | - | - | 42 | - | - | - | - | - | - | 44 | - | - | - | 170,0 | - | - | - | - | - | - | - | - | - | - | - | - | - | | | | | | | | | | | | | | | | | | | | | | | | | | | | | | | | | | | | | | | | | | | | | | | | | | | | | | | | | | | | | | | |
| 86 | 9,1 | 38,6* | 39,7 | 32,2 | - | - | - | 44 | - | - | - | 170,0 | - | - | 46 | - | - | - | 162,0 | - | - | - | - | - | - | - | - | - | - | - | - | - | | | | | | | | | | | | | | | | | | | | | | | | | | | | | | | | | | | | | | | | | | | | | | | | | | | | | | | | | | | | | | | |
| 90 | 7,9 | 37,8* | 39,4 | 32,2 | - | - | - | 46 | - | - | - | 162,0 | - | - | 50 | - | - | - | 147,0 | - | - | - | - | - | - | - | - | - | - | - | - | - | | | | | | | | | | | | | | | | | | | | | | | | | | | | | | | | | | | | | | | | | | | | | | | | | | | | | | | | | | | | | | | |
| 94 | 6,7 | 34,0* | 39,3 | 32,2 | - | - | - | 50 | - | - | - | 147,0 | - | - | 51 | - | - | - | 143,0 | - | - | - | - | - | - | - | - | - | - | - | - | - | | | | | | | | | | | | | | | | | | | | | | | | | | | | | | | | | | | | | | | | | | | | | | | | | | | | | | | | | | | | | | | |
| 98 | 5,7 | 29,3* | 39,1 | 32,2 | - | - | - | 51 | - | - | - | 143,0 | - | - | 54 | - | - | - | - | - | - | - | - | - | - | - | - | - | - | - | - | - | | | | | | | | | | | | | | | | | | | | | | | | | | | | | | | | | | | | | | | | | | | | | | | | | | | | | | | | | | | | | | | |
| 99 | 4,2* | 28,1* | 38,9 | 32,2 | - | - | - | 54 | - | - | - | - | - | - | 56 | - | - | - | - | - | - | - | - | - | - | - | - | - | - | - | - | - | | | | | | | | | | | | | | | | | | | | | | | | | | | | | | | | | | | | | | | | | | | | | | | | | | | | | | | | | | | | | | | |
| 102 | - | - | 38,5 | 32,2 | - | - | - | 56 | - | - | - | - | - | - | 58 | - | - | - | - | - | - | - | - | - | - | - | - | - | - | - | - | - | | | | | | | | | | | | | | | | | | | | | | | | | | | | | | | | | | | | | | | | | | | | | | | | | | | | | | | | | | | | | | | |
| 103 | - | - | 37,3 | 32,2 | 26,3 | - | - | 58 | - | - | - | - | - | - | 60 | - | - | - | - | - | - | - | - | - | - | - | - | - | - | - | - | - | | | | | | | | | | | | | | | | | | | | | | | | | | | | | | | | | | | | | | | | | | | | | | | | | | | | | | | | | | | | | | | |
| 106 | - | - | 34,0 | 32,2 | 26,3 | 30,5 | - | 60 | - | - | - | - | - | - | 62 | - | - | - | - | - | - | - | - | - | - | - | - | - | - | - | - | - | | | | | | | | | | | | | | | | | | | | | | | | | | | | | | | | | | | | | | | | | | | | | | | | | | | | | | | | | | | | | | | |
| 109 | - | - | 30,4 | 32,2 | 26,3 | 29,9 | - | 62 | - | - | - | - | - | - | 66 | - | - | - | - | - | - | - | - | - | - | - | - | - | - | - | - | - | | | | | | | | | | | | | | | | | | | | | | | | | | | | | | | | | | | | | | | | | | | | | | | | | | | | | | | | | | | | | | | |
| 110 | - | - | - | 32,2 | 26,3 | 29,7 | - | 66 | - | - | - | - | - | - | 70 | - | - | - | - | - | - | - | - | - | - | - | - | - | - | - | - | - | | | | | | | | | | | | | | | | | | | | | | | | | | | | | | | | | | | | | | | | | | | | | | | | | | | | | | | | | | | | | | | |
| 114 | - | - | - | 32,2 | 26,3 | 29,0 | - | 70 | - | - | - | - | - | - | 74 | - | - | - | - | - | - | - | - | - | - | - | - | - | - | - | - | - | | | | | | | | | | | | | | | | | | | | | | | | | | | | | | | | | | | | | | | | | | | | | | | | | | | | | | | | | | | | | | | |
| 118 | - | - | - | 32,2 | 26,3 | 28,2 | - | 74 | - | - | - | - | - | - | 77 | - | - | - | - | - | - | - | - | - | - | - | - | - | - | - | - | - | | | | | | | | | | | | | | | | | | | | | | | | | | | | | | | | | | | | | | | | | | | | | | | | | | | | | | | | | | | | | | | |
| 122 | - | - | - | - | 26,3 | 27,6 | - | 77 | - | - | - | - | - | - | - | - | - | - | - | - | - | - | - | - | - | - | - | - | - | - | - | - | | | | | | | | | | | | | | | | | | | | | | | | | | | | | | | | | | | | | | | | | | | | | | | | | | | | | | | | | | | | | | | |
| 126 | - | - | - | - | 26,3 | 27,0 | - | - | - | - | - | - | - | - | - | - | - | - | - | - | - | - | - | - | - | - | - | - | - | - | - | - | | | | | | | | | | | | | | | | | | | | | | | | | | | | | | | | | | | | | | | | | | | | | | | | | | | | | | | | | | | | | | | |
| 130 | - | - | - | - | - | 25,1 | - | - | - | - | - | - | - | - | - | - | - | - | - | - | - | - | - | - | - | - | - | - | - | - | - | - | | | | | | | | | | | | | | | | | | | | | | | | | | | | | | | | | | | | | | | | | | | | | | | | | | | | | | | | | | | | | | | |
| 134 | - | - | - | - | - | 21,8 | - | - | - | - | - | - | - | - | - | - | - | - | - | - | - | - | - | - | - | - | - | - | - | - | - | - | | | | | | | | | | | | | | | | | | | | | | | | | | | | | | | | | | | | | | | | | | | | | | | | | | | | | | | | | | | | | | | |
| 138 | - | - | - | - | - | 17,9 | - | - | - | - | - | - | - | - | - | - | - | - | - | - | - | - | - | - | - | - | - | - | - | - | - | - | | | | | | | | | | | | | | | | | | | | | | | | | | | | | | | | | | | | | | | | | | | | | | | | | | | | | | | | | | | | | | | |
| 142 | - | - | - | - | - | 15,0 | - | - | - | - | - | - | - | - | - | - | - | - | - | - | - | - | - | - | - | - | - | - | - | - | - | - | | | | | | | | | | | | | | | | | | | | | | | | | | | | | | | | | | | | | | | | | | | | | | | | | | | | | | | | | | | | | | | |

0 t 65 t 125 t 165 t 205 t 245 t 285 t 325 t

* Main boom angle 85° · Hauptauslegerwinkel 85° · Jarret de flèche principale 85° · Inclinação braccio base 85° ·
 Ángulo de pluma principal 85° · Ángulo da lança principal 85° · Угол подъема гл. стрелы 85°

Main boom angle 87°, 85°, 75°, 65° and 55°, capacities for intermediate boom positions are calculated by the crane control system IC-1 ·
 Hauptauslegerwinkel 87°, 85°, 75°, 65° und 55°, Traglasten für Zwischenstellungen des Hauptauslegers werden von der Kransteuerung
 IC-1 berechnet · Jarret de flèche principale 87°, 85°, 75°, 65° et 55°, le système de commande de la grue IC-1 calcule les charges pour les
 positions intermédiaires de la flèche · Inclinação braccio base 87°, 85°, 75°, 65° e 55°, capacità per posizioni intermedie del braccio sono
 calcolate dal sistema di controllo della gru IC-1 · Ángulo de pluma principal 87°, 85°, 75°, 65° y 55°, las capacidades para posiciones de
 pluma intermedias son calculadas por el sistema de control de grúa IC-1 · Ângulos da lança principal 87°, 85°, 75°, 65° e 55°, as capacidades
 para posições da lança intermediária são calculadas pelo sistema de controle da grua IC-1 · Грузоподъемность при углах подъема
 главной стрелы 87°, 85°, 75°, 65° и 55°, грузоподъемность в промежуточных положениях стрелы рассчитывается системой
 управления краном IC-1

| 165 t + 50 t | | | | | | | | 11-19 m | | | | | | | | 8,40 m | | | | | | | | 9.8 m/s | | | | | | | | 360° | | | | | | | | ISO | | | | | | | | | | | | | | | | | | | | | | | | | | | | | | | | | | | | | | | | | | | | | | | | | | | | | | | |
|--------------|-------|--------|-------|-------|---|---|-------|-----------|-------|--------|-------|-------|------|---|---|--------|-------|--------|-------|-------|------|---|---|-------------|---|---|---|---|---|---|---|--------|---|---|---|---|---|---|---|-----------|---|---|---|---|---|---|---|---------|--|--|--|--|--|--|--|---------|--|--|--|--|--|--|--|-----|--|--|--|--|--|--|--|-----|--|--|--|--|--|--|--|-----|--|--|--|--|--|--|--|-----|--|--|--|--|--|--|--|
| 60 m + 36 m | | | | | | | | SWSL_1 | | | | | | | | SFSL_1 | | | | | | | | 60 m + 48 m | | | | | | | | SWSL_1 | | | | | | | | SFSL_1 | | | | | | | | | | | | | | | | | | | | | | | | | | | | | | | | | | | | | | | | | | | | | | | | | | | | | | | |
| 0 t | | | | | | | | 0 t-325 t | | | | | | | | 0 t | | | | | | | | 0 t-325 t | | | | | | | | 0 t | | | | | | | | 0 t-325 t | | | | | | | | | | | | | | | | | | | | | | | | | | | | | | | | | | | | | | | | | | | | | | | | | | | | | | | |
| 87°/85° | | | | | | | | 87°/85° | | | | | | | | 75° | | | | | | | | 65° | | | | | | | | 55° | | | | | | | | 15° | | | | | | | | 87°/85° | | | | | | | | 87°/85° | | | | | | | | 75° | | | | | | | | 65° | | | | | | | | 55° | | | | | | | | 15° | | | | | | | |
| m | t | t | t | t | t | t | t | m | t | t | t | t | t | t | t | m | t | t | t | t | t | t | t | m | t | t | t | t | t | t | t | m | t | t | t | t | t | t | t | m | t | t | t | t | t | t | t | | | | | | | | | | | | | | | | | | | | | | | | | | | | | | | | | | | | | | | | | | | | | | | | |
| 15 | 154,0 | 217,0 | - | - | - | - | - | 18 | 121,0 | 160,0 | - | - | - | - | - | 20 | 110,0 | 158,0 | - | - | - | - | - | - | - | - | - | - | - | - | - | - | - | - | - | - | - | - | | | | | | | | | | | | | | | | | | | | | | | | | | | | | | | | | | | | | | | | | | | | | | | | | | | | | | | | | |
| 16 | 145,0 | 216,0 | - | - | - | - | - | 20 | 101,0 | 162,0* | - | - | - | - | - | 22 | 93,0 | 161,0* | - | - | - | - | - | - | - | - | - | - | - | - | - | - | - | - | - | - | - | | | | | | | | | | | | | | | | | | | | | | | | | | | | | | | | | | | | | | | | | | | | | | | | | | | | | | | | | | |
| 18 | 131,0 | 220,0* | - | - | - | - | - | 24 | 89,5 | 160,0* | - | - | - | - | - | 25 | 86,0 | 159,0* | - | - | - | - | - | - | - | - | - | - | - | - | - | - | - | - | - | - | - | - | | | | | | | | | | | | | | | | | | | | | | | | | | | | | | | | | | | | | | | | | | | | | | | | | | | | | | | | | |
| 20 | 119,0 | 220,0* | - | - | - | - | - | 26 | 80,0 | 158,0* | - | - | - | - | - | 28 | 74,5 | 156,0* | - | - | - | - | - | - | - | - | - | - | - | - | - | - | - | - | - | - | - | - | | | | | | | | | | | | | | | | | | | | | | | | | | | | | | | | | | | | | | | | | | | | | | | | | | | | | | | | | |
| 21 | 114,0 | 218,5* | - | - | - | - | 212,0 | 30 | 65,5 | 151,0* | - | - | - | - | - | 34 | 58,0 | 146,0* | - | - | - | - | - | - | - | - | - | - | - | - | - | - | - | - | - | - | - | - | | | | | | | | | | | | | | | | | | | | | | | | | | | | | | | | | | | | | | | | | | | | | | | | | | | | | | | | | |
| 22 | 109,0 | 217,0* | - | - | - | - | 212,0 | 34 | 54,7 | 143,0* | 153,0 | - | - | - | - | 38 | 51,5 | 140,0* | 152,0 | - | - | - | - | - | - | - | - | - | - | - | - | - | - | - | - | - | - | - | - | | | | | | | | | | | | | | | | | | | | | | | | | | | | | | | | | | | | | | | | | | | | | | | | | | | | | | | | |
| 24 | 100,0 | 213,0* | - | - | - | - | 212,0 | 40 | 45,5 | 122,0* | 152,0 | - | - | - | - | 42 | 40,4 | 104,0* | 150,0 | - | - | - | - | - | - | - | - | - | - | - | - | - | - | - | - | - | - | - | - | | | | | | | | | | | | | | | | | | | | | | | | | | | | | | | | | | | | | | | | | | | | | | | | | | | | | | | | |
| 26 | 93,0 | 208,0* | - | - | - | - | 212,0 | 46 | 38,2 | 94,2* | 143,5 | - | - | - | - | 50 | 34,5* | 84,5* | 137,0 | - | - | - | - | - | - | - | - | - | - | - | - | - | - | - | - | - | - | - | - | | | | | | | | | | | | | | | | | | | | | | | | | | | | | | | | | | | | | | | | | | | | | | | | | | | | | | | | |
| 28 | 86,5 | 203,0* | - | - | - | - | 212,0 | 52 | - | - | 124,2 | 121,0 | - | - | - | 54 | - | - | 120,0 | 118,0 | - | - | - | - | - | - | - | - | - | - | - | - | - | - | - | - | - | - | - | | | | | | | | | | | | | | | | | | | | | | | | | | | | | | | | | | | | | | | | | | | | | | | | | | | | | | | | |
| 30 | 80,5 | 198,0* | - | - | - | - | 211,0 | 54 | - | - | 102,0 | 109,0 | - | - | - | 57 | - | - | 102,0 | 109,0 | - | - | - | - | - | - | - | - | - | - | - | - | - | - | - | - | - | - | - | | | | | | | | | | | | | | | | | | | | | | | | | | | | | | | | | | | | | | | | | | | | | | | | | | | | | | | | |
| 34 | 70,5 | 186,0* | - | - | - | - | 208,0 | 58 | - | - | 93,0 | 105,0 | - | - | - | 62 | - | - | 93,0 | 105,0 | - | - | - | - | - | - | - | - | - | - | - | - | - | - | - | - | - | - | - | | | | | | | | | | | | | | | | | | | | | | | | | | | | | | | | | | | | | | | | | | | | | | | | | | | | | | | | |
| 35 | 68,0 | 178,2* | 212,0 | - | - | - | 208,0 | 64 | - | - | 90,0 | 101,0 | - | - | - | 66 | - | - | 90,0 | 101,0 | - | - | - | - | - | - | - | - | - | - | - | - | - | - | - | - | - | - | - | | | | | | | | | | | | | | | | | | | | | | | | | | | | | | | | | | | | | | | | | | | | | | | | | | | | | | | | |
| 38 | 60,5 | 155,0* | 207,0 | - | - | - | 199,6 | 66 | - | - | 88,5 | 88,5 | 83,0 | - | - | 70 | - | - | 88,5 | 88,5 | 84,5 | - | - | - | - | - | - | - | - | - | - | - | - | - | - | - | - | - | | | | | | | | | | | | | | | | | | | | | | | | | | | | | | | | | | | | | | | | | | | | | | | | | | | | | | | | | |
| 40 | 56,5 | 138,0* | 196,5 | - | - | - | 191,3 | 70 | - | - | 89,7 | 83,0 | 78,0 | - | - | 73 | - | - | 89,7 | 83,0 | 78,0 | - | - | - | - | - | - | - | - | - | - | - | - | - | - | - | - | - | - | | | | | | | | | | | | | | | | | | | | | | | | | | | | | | | | | | | | | | | | | | | | | | | | | | | | | | | | |
| 42 | 51,0* | 121,0* | 186,0 | - | - | - | 183,0 | 74 | - | - | 90,0 | 87,8 | 71,0 | - | - | 74 | - | - | 90,0 | 87,8 | 71,0 | - | - | - | - | - | - | - | - | - | - | - | - | - | - | - | - | - | - | | | | | | | | | | | | | | | | | | | | | | | | | | | | | | | | | | | | | | | | | | | | | | | | | | | | | | | | |
| 46 | - | - | 168,0 | - | - | - | 163,0 | 78 | - | - | 82,6 | 82,6 | 69,5 | - | - | 78 | - | - | 82,6 | 82,6 | 69,5 | - | - | - | - | - | - | - | - | - | - | - | - | - | - | - | - | - | - | | | | | | | | | | | | | | | | | | | | | | | | | | | | | | | | | | | | | | | | | | | | | | | | | | | | | | | | |
| 50 | - | - | 150,0 | - | - | - | 145,3 | 82 | - | - | 98,0 | 98,0 | 65,1 | - | - | 82 | - | - | 98,0 | 98,0 | 65,1 | - | - | - | - | - | - | - | - | - | - | - | - | - | - | - | - | - | - | | | | | | | | | | | | | | | | | | | | | | | | | | | | | | | | | | | | | | | | | | | | | | | | | | | | | | | | |
| 51 | - | - | 141,5 | 141,0 | - | - | 141,5 | 86 | - | - | 91,5 | 89,7 | 59,5 | - | - | 86 | - | - | 91,5 | 89,7 | 59,5 | - | - | - | - | - | - | - | - | - | - | - | - | - | - | - | - | - | - | | | | | | | | | | | | | | | | | | | | | | | | | | | | | | | | | | | | | | | | | | | | | | | | | | | | | | | | |
| 52 | - | - | 133,0 | 137,0 | - | - | 137,6 | 90 | - | - | 90,0 | 87,8 | 52,0 | - | - | 90 | - | - | 90,0 | 87,8 | 52,0 | - | - | - | - | - | - | - | - | - | - | - | - | - | - | - | - | - | - | | | | | | | | | | | | | | | | | | | | | | | | | | | | | | | | | | | | | | | | | | | | | | | | | | | | | | | | |
| 54 | - | - | - | 131,0 | - | - | 130,0 | 94 | - | - | 87,0 | 87,0 | 46,0 | - | - | 94 | - | - | 87,0 | 87,0 | 46,0 | - | - | - | - | - | - | - | - | - | - | - | - | - | - | - | - | - | - | | | | | | | | | | | | | | | | | | | | | | | | | | | | | | | | | | | | | | | | | | | | | | | | | | | | | | | | |
| 58 | - | - | - | 121,0 | - | - | 118,0 | 98 | - | - | 82,6 | 82,6 | 41,7 | - | - | 98 | - | - | 82,6 | 82,6 | 41,7 | - | - | - | - | - | - | - | - | - | - | - | - | - | - | - | - | - | - | | | | | | | | | | | | | | | | | | | | | | | | | | | | | | | | | | | | | | | | | | | | | | | | | | | | | | | | |
| 62 | - | - | - | 112,0 | - | - | 107,3 | 101 | - | - | 82,6 | 82,6 | 38,0 | - | - | 101 | - | - | 82,6 | 82,6 | 38,0 | - | - | - | - | - | - | - | - | - | - | - | - | - | - | - | - | - | - | | | | | | | | | | | | | | | | | | | | | | | | | | | | | | | | | | | | | | | | | | | | | | | | | | | | | | | | |
| 65 | - | - | - | - | - | - | 100,0 | 100,3 | - | - | 82,6 | 82,6 | 34,0 | - | - | 105 | - | - | 82,6 | 82,6 | 34,0 | - | - | - | - | - | - | - | - | - | - | - | - | - | - | - | - | - | - | | | | | | | | | | | | | | | | | | | | | | | | | | | | | | | | | | | | | | | | | | | | | | | | | | | | | | | | |
| 66 | - | - | - | - | - | - | 98,0 | 98,0 | - | - | 82,6 | 82,6 | 30,0 | - | - | 110 | - | - | 82,6 | 82,6 | 30,0 | - | - | - | - | - | - | - | - | - | - | - | - | - | - | - | - | - | - | - | | | | | | | | | | | | | | | | | | | | | | | | | | | | | | | | | | | | | | | | | | | | | | | | | | | | | | | |
| 70 | - | - | - | - | - | - | 91,5 | 89,7 | - | - | 82,6 | 82,6 | 26,0 | - | - | 120 | - | - | 82,6 | 82,6 | 26,0 | - | - | - | - | - | - | - | - | - | - | - | - | - | - | - | - | - | - | - | | | | | | | | | | | | | | | | | | | | | | | | | | | | | | | | | | | | | | | | | | | | | | | | | | | | | | | |
| 71 | - | - | - | - | - | - | 90,0 | 87,8 | - | - | 82,6 | 82,6 | 22,0 | - | - | 130 | - | - | 82,6 | 82,6 | 22,0 | - | - | - | - | - | - | - | - | - | - | - | - | - | - | - | - | - | - | - | | | | | | | | | | | | | | | | | | | | | | | | | | | | | | | | | | | | | | | | | | | | | | | | | | | | | | | |
| 74 | - | - | - | - | - | - | 82,6 | 82,6 | - | - | 82,6 | 82,6 | 18,0 | - | - | 140 | - | - | 82,6 | 82,6 | 18,0 | - | - | - | - | - | - | - | - | - | - | - | - | - | - | - | - | - | - | - | | | | | | | | | | | | | | | | | | | | | | | | | | | | | | | | | | | | | | | | | | | | | | | | | | | | | | | |
| 78 | - | - | - | - | - | - | 76,0 | 76,0 | - | - | 82,6 | 82,6 | 14,0 | - | - | 150 | - | - | 82,6 | 82,6 | 14,0 | - | - | - | - | - | - | - | - | - | - | - | - | - | - | - | - | - | - | - | | | | | | | | | | | | | | | | | | | | | | | | | | | | | | | | | | | | | | | | | | | | | | | | | | | | | | | |
| 82 | - | - | - | - | - | - | 67,0 | 67,0 | - | - | 82,6 | 82,6 | 10,0 | - | - | 160 | - | - | 82,6 | 82,6 | 10,0 | - | - | - | - | - | - | - | - | - | - | - | - | - | - | - | - | - | - | - | | | | | | | | | | | | | | | | | | | | | | | | | | | | | | | | | | | | | | | | | | | | | | | | | | | | | | | |
| 86 | - | - | - | - | - | - | 58,5 | 58,5 | - | - | 82,6 | 82,6 | 6,0 | - | - | 170 | - | - | 82,6 | 82,6 | 6,0 | - | - | - | - | - | - | - | - | - | - | - | - | - | - | - | - | - | - | - | | | | | | | | | | | | | | | | | | | | | | | | | | | | | | | | | | | | | | | | | | | | | | | | | | | | | | | |
| 89 | - | - | - | - | - | - | 54,0 | 54,0 | - | - | 82,6 | 82,6 | 2,0 | - | - | 180 | - | - | 82,6 | 82,6 | 2,0 | - | - | - | - | - | - | - | - | - | - | - | - | - | - | - | - | - | - | - | | | | | | | | | | | | | | | | | | | | | | | | | | | | | | | | | | | | | | | | | | | | | | | | | | | | | | | |

* Main boom angle 85° · Hauptauslegerwinkel 85° · Jarret de flèche principale 85° · Inclinazione braccio base 85° · Ángulo de pluma principal 85° · Ângulo da lança principal 85° · Угол подъема гл. стрелы 85°

Main boom angle 87°, 85°, 75°, 65° and 55°, capacities for intermediate boom positions are calculated by the crane control system IC-1 · Hauptauslegerwinkel 87°, 85°, 75°, 65° und 55°, Traglasten für Zwischenstellungen des Hauptauslegers werden von der Kransteuerung IC-1 berechnet · Jarret de flèche principale 87°, 85°, 75°, 65° et 55°, le système de commande de la grue IC-1 calcule les charges pour les positions intermédiaires de la flèche · Inclinazione braccio base 87°, 85°, 75°, 65° e 55°, capacità per posizioni intermedie del braccio sono calcolate dal sistema di controllo della gru IC-1 · Ângulo de pluma principal 87°, 85°, 75°, 65° y 55°, las capacidades para posiciones de pluma intermedias son calculadas por el sistema de control de grúa IC-1 · Ângulos da lança principal 87°, 85°, 75°, 65° e 55°, as capacidades para posições da lança intermediária são calculadas pelo sistema de controle da grua IC-1 · Грузоподъемность при углах подъема главной стрелы 87°, 85°, 75°, 65° и 55°, грузоподъемность в промежуточных положениях стрелы рассчитывается системой управления краном IC-1

| 165 t + 50 t | | 11-19 m | | 8,40 m | | 9.8 m/s | | 360° | | ISO | |
|--------------|-------|-----------|-------|--------|------|-------------|-------|-----------|------|------|------|
| 60 m + 60 m | | | | | | 60 m + 72 m | | | | | |
| SWSL_1 | | | | | | SWSL_1 | | | | | |
| SFSL_1 | | | | | | SFSL_1 | | | | | |
| 0 t | | 0 t-325 t | | | | 0 t | | 0 t-325 t | | | |
| 87°/85° | | 87°/85° | | 75° | | 65° | | 55° | | 15° | |
| m | t | t | t | t | t | m | t | t | t | t | t |
| 20 | 103,0 | 119,0 | - | - | - | 23 | 84,0 | 88,5 | - | - | - |
| 22 | 94,0 | 118,0 | - | - | - | 24 | 80,5 | 88,5 | - | - | - |
| 24 | 86,5 | 117,0 | - | - | - | 26 | 74,5 | 88,0 | - | - | - |
| 26 | 80,0 | 119,0* | - | - | - | 28 | 69,0 | 88,5* | - | - | - |
| 28 | 74,5 | 119,0* | - | - | - | 30 | 64,0 | 88,0* | - | - | - |
| 30 | 69,5 | 118,0* | - | - | - | 34 | 56,0 | 87,5* | - | - | 86,5 |
| 34 | 60,5 | 116,0* | - | - | - | 38 | 49,5 | 86,5* | - | - | 86,5 |
| 38 | 53,5 | 114,0* | - | - | - | 42 | 43,9 | 85,0* | - | - | 86,5 |
| 42 | 48,0 | 111,0* | - | - | - | 46 | 39,2 | 83,5* | - | - | 84,8 |
| 45 | 44,2 | 108,7* | 108,0 | - | - | 50 | 35,1 | 82,0* | 78,0 | - | 83,3 |
| 46 | 43,0 | 108,0* | 108,0 | - | - | 54 | 31,6 | 80,0* | 78,0 | - | 82,0 |
| 50 | 38,8 | 105,0* | 108,0 | - | - | 58 | 28,5 | 78,5* | 78,0 | - | 80,0 |
| 54 | 34,8 | 96,0* | 108,0 | - | - | 62 | 25,8 | 77,0* | 78,0 | - | 78,0 |
| 58 | 31,2 | 83,5* | 108,0 | - | - | 66 | 23,5 | 69,5* | 78,0 | - | 76,0 |
| 62 | 28,1 | 71,5* | 108,0 | - | - | 70 | 21,2 | 61,5* | 78,0 | 64,5 | 74,4 |
| 63 | 27,4 | 68,5* | 104,8 | - | - | 74 | 19,0 | 53,0* | 78,0 | 64,5 | 72,1 |
| 64 | 25,1* | 65,5* | 101,7 | 93,5 | - | 75 | 18,5 | 50,8* | 76,0 | 64,5 | 71,7 |
| 65 | 24,5* | 62,5* | 98,6 | 93,5 | - | 77 | 16,0* | 46,6* | 72,0 | 64,5 | 70,9 |
| 66 | - | - | 95,5 | 93,5 | - | 78 | - | - | 70,0 | 64,5 | 70,5 |
| 70 | - | - | 83,5 | 92,5 | - | 82 | - | - | 62,0 | 64,5 | 68,3 |
| 74 | - | - | 72,0 | 86,5 | - | 86 | - | - | 54,0 | 64,5 | 65,6 |
| 76 | - | - | 66,0 | 83,5 | - | 87 | - | - | 52,0 | 64,5 | 64,7 |
| 78 | - | - | - | 81,0 | - | 90 | - | - | - | 64,5 | 55,5 |
| 81 | - | - | - | 77,2 | 72,5 | 94 | - | - | - | 61,5 | 55,5 |
| 82 | - | - | - | 76,0 | 71,5 | 97 | - | - | - | 55,5 | 54,7 |
| 86 | - | - | - | 70,5 | 67,0 | 98 | - | - | - | - | 54,5 |
| 90 | - | - | - | - | 63,5 | 102 | - | - | - | - | 52,0 |
| 94 | - | - | - | - | 60,0 | 106 | - | - | - | - | 49,4 |
| 95 | - | - | - | - | 59,0 | 110 | - | - | - | - | - |
| 98 | - | - | - | - | - | 114 | - | - | - | - | - |
| 102 | - | - | - | - | - | 118 | - | - | - | - | - |
| 106 | - | - | - | - | - | 122 | - | - | - | - | - |
| 110 | - | - | - | - | - | 124 | - | - | - | - | - |
| 112 | - | - | - | - | - | | | | | | |

0 t 65 t 125 t 165 t 205 t 245 t 285 t 325 t

* Main boom angle 85° · Hauptauslegerwinkel 85° · Jarret de flèche principale 85° · Inclinação braccio base 85° · Ángulo de pluma principal 85° · Ángulo da lança principal 85° · Угол подъема гл. стрелы 85°

Main boom angle 87°, 85°, 75°, 65° and 55°, capacities for intermediate boom positions are calculated by the crane control system IC-1 · Hauptauslegerwinkel 87°, 85°, 75°, 65° und 55°, Traglasten für Zwischenstellungen des Hauptauslegers werden von der Kransteuerung IC-1 berechnet · Jarret de flèche principale 87°, 85°, 75°, 65° et 55°, le système de commande de la grue IC-1 calcule les charges pour les positions intermédiaires de la flèche · Inclinação braccio base 87°, 85°, 75°, 65° e 55°, capacità per posizioni intermedie del braccio sono calcolate dal sistema di controllo della gru IC-1 · Ángulo de pluma principal 87°, 85°, 75°, 65° y 55°, las capacidades para posiciones de pluma intermedias son calculadas por el sistema de control de grúa IC-1 · Ângulos da lança principal 87°, 85°, 75°, 65° e 55°, as capacidades para posições da lança intermediária são calculadas pelo sistema de controle da grua IC-1 · Грузоподъемность при углах подъема главной стрелы 87°, 85°, 75°, 65° и 55°, грузоподъемность в промежуточных положениях стрелы рассчитывается системой управления краном IC-1

| 165 t + 50 t | | | | | | | | 11-19 m | | | | | | | | 8,40 m | | | | | | | | 9.8 m/s | | | | | | | | 360° | | | | | | | | ISO | | | | | | | |
|--------------|------|---------|------|-----------|------|-----|------|-------------|------|-------|------|-----------|------|---------|---|--------|---|-----|---|-----|---|------|--|---------|--|--|--|--|--|--|--|------|--|--|--|--|--|--|--|-----|--|--|--|--|--|--|--|
| 60 m + 84 m | | | | | | | | 60 m + 96 m | | | | | | | | | | | | | | | | | | | | | | | | | | | | | | | | | | | | | | | |
| SWSL_1 | | | | SFSL_1 | | | | SWSL_1 | | | | SFSL_1 | | | | | | | | | | | | | | | | | | | | | | | | | | | | | | | | | | | |
| 0 t | | | | 0 t-325 t | | | | 0 t | | | | 0 t-325 t | | | | | | | | | | | | | | | | | | | | | | | | | | | | | | | | | | | |
| 87°/85° | | 87°/85° | | 75° | | 65° | | 55° | | 15° | | 87°/85° | | 87°/85° | | 75° | | 65° | | 55° | | 15° | | | | | | | | | | | | | | | | | | | | | | | | | |
| m | t | t | t | t | t | t | t | m | t | t | t | t | t | t | t | t | t | t | t | t | t | t | | | | | | | | | | | | | | | | | | | | | | | | | |
| 26 | 63,5 | 65,0 | - | - | - | - | - | 29 | 46,5 | 47,5 | - | - | - | - | - | - | - | - | - | - | - | - | | | | | | | | | | | | | | | | | | | | | | | | | |
| 28 | 63,0 | 64,5 | - | - | - | - | - | 30 | 46,4 | 47,3 | - | - | - | - | - | - | - | - | - | - | - | - | | | | | | | | | | | | | | | | | | | | | | | | | |
| 30 | 59,0 | 64,0 | - | - | - | - | - | 34 | 45,5 | 46,6* | - | - | - | - | - | - | - | - | - | - | - | - | | | | | | | | | | | | | | | | | | | | | | | | | |
| 34 | 51,5 | 63,5* | - | - | - | - | - | 38 | 41,2 | 46,0* | - | - | - | - | - | - | - | - | - | - | - | - | | | | | | | | | | | | | | | | | | | | | | | | | |
| 38 | 45,2 | 63,0* | - | - | - | - | 62,5 | 42 | 36,0 | 45,3* | - | - | - | - | - | - | - | - | - | - | - | 45,1 | | | | | | | | | | | | | | | | | | | | | | | | | |
| 42 | 39,9 | 62,0* | - | - | - | - | 62,0 | 46 | 31,7 | 44,6* | - | - | - | - | - | - | - | - | - | - | - | 44,5 | | | | | | | | | | | | | | | | | | | | | | | | | |
| 46 | 35,3 | 61,5* | - | - | - | - | 61,3 | 50 | 27,9 | 43,9* | - | - | - | - | - | - | - | - | - | - | - | 43,7 | | | | | | | | | | | | | | | | | | | | | | | | | |
| 50 | 31,4 | 60,5* | - | - | - | - | 60,3 | 54 | 24,6 | 43,1* | - | - | - | - | - | - | - | - | - | - | - | 42,9 | | | | | | | | | | | | | | | | | | | | | | | | | |
| 54 | 28,0 | 59,5* | - | - | - | - | 59,0 | 58 | 21,7 | 42,3* | - | - | - | - | - | - | - | - | - | - | - | 41,9 | | | | | | | | | | | | | | | | | | | | | | | | | |
| 55 | 27,2 | 59,2* | 55,0 | - | - | - | 58,7 | 60 | 20,4 | 41,9* | 38,7 | - | - | - | - | - | - | - | - | - | - | 41,4 | | | | | | | | | | | | | | | | | | | | | | | | | |
| 58 | 25,0 | 58,5* | 55,0 | - | - | - | 58,0 | 62 | 19,1 | 41,5* | 38,7 | - | - | - | - | - | - | - | - | - | - | 40,8 | | | | | | | | | | | | | | | | | | | | | | | | | |
| 62 | 22,4 | 57,0* | 55,0 | - | - | - | 56,6 | 66 | 16,9 | 40,7* | 38,7 | - | - | - | - | - | - | - | - | - | - | 39,8 | | | | | | | | | | | | | | | | | | | | | | | | | |
| 66 | 20,1 | 56,5* | 55,0 | - | - | - | 55,0 | 70 | 14,8 | 39,9* | 38,7 | - | - | - | - | - | - | - | - | - | - | 38,7 | | | | | | | | | | | | | | | | | | | | | | | | | |
| 70 | 18,0 | 55,5* | 55,0 | - | - | - | 53,7 | 74 | 13,0 | 39,2* | 38,7 | - | - | - | - | - | - | - | - | - | - | 37,6 | | | | | | | | | | | | | | | | | | | | | | | | | |
| 74 | 16,1 | 54,5* | 55,0 | - | - | - | 52,3 | 78 | 11,3 | 38,5* | 38,6 | - | - | - | - | - | - | - | - | - | - | 36,5 | | | | | | | | | | | | | | | | | | | | | | | | | |
| 77 | 14,8 | 52,2* | 55,0 | 45,1 | - | - | 51,3 | 82 | 9,8 | 37,8* | 38,4 | - | - | - | - | - | - | - | - | - | - | 35,5 | | | | | | | | | | | | | | | | | | | | | | | | | |
| 78 | 14,4 | 51,5* | 55,0 | 45,1 | - | - | 51,0 | 84 | 9,1 | 37,4* | 38,3 | 30,4 | - | - | - | - | - | - | - | - | - | 35,0 | | | | | | | | | | | | | | | | | | | | | | | | | |
| 82 | 12,9 | 45,4* | 55,0 | 45,1 | - | - | 49,8 | 86 | 8,4 | 37,1* | 38,3 | 30,4 | - | - | - | - | - | - | - | - | - | 34,4 | | | | | | | | | | | | | | | | | | | | | | | | | |
| 86 | 11,5 | 39,4* | 55,0 | 45,1 | - | - | 48,4 | 90 | 7,1 | 36,4* | 38,1 | 30,4 | - | - | - | - | - | - | - | - | - | 33,5 | | | | | | | | | | | | | | | | | | | | | | | | | |
| 88 | 9,4* | 36,1* | 53,7 | 45,1 | - | - | 47,8 | 94 | 6,0 | 33,5* | 38,0 | 30,4 | - | - | - | - | - | - | - | - | - | 32,5 | | | | | | | | | | | | | | | | | | | | | | | | | |
| 90 | - | - | 52,5 | 45,1 | - | - | 47,2 | 98 | 5,0 | 28,8* | 37,9 | 30,4 | - | - | - | - | - | - | - | - | - | 31,5 | | | | | | | | | | | | | | | | | | | | | | | | | |
| 94 | - | - | 46,6 | 45,1 | - | - | 45,8 | 100 | - | 26,2* | 37,7 | 30,4 | - | - | - | - | - | - | - | - | - | 31,0 | | | | | | | | | | | | | | | | | | | | | | | | | |
| 98 | - | - | 40,5 | 45,1 | 37,9 | - | 44,6 | 102 | - | - | 37,7 | 30,4 | - | - | - | - | - | - | - | - | - | 30,6 | | | | | | | | | | | | | | | | | | | | | | | | | |
| 99 | - | - | 38,9 | 45,1 | 37,9 | - | 44,3 | 106 | - | - | 34,8 | 30,4 | 24,6 | - | - | - | - | - | - | - | - | 29,7 | | | | | | | | | | | | | | | | | | | | | | | | | |
| 102 | - | - | - | 45,1 | 37,9 | - | 43,4 | 110 | - | - | 30,0 | 30,4 | 24,6 | - | - | - | - | - | - | - | - | 28,9 | | | | | | | | | | | | | | | | | | | | | | | | | |
| 106 | - | - | - | 45,1 | 37,9 | - | 42,2 | 114 | - | - | - | 30,4 | 24,6 | - | - | - | - | - | - | - | - | 28,1 | | | | | | | | | | | | | | | | | | | | | | | | | |
| 109 | - | - | - | 42,1 | 37,9 | - | 41,2 | 118 | - | - | - | 30,4 | 24,6 | - | - | - | - | - | - | - | - | 27,4 | | | | | | | | | | | | | | | | | | | | | | | | | |
| 110 | - | - | - | - | 37,9 | - | 40,7 | 120 | - | - | - | 30,4 | 24,6 | - | - | - | - | - | - | - | - | 27,1 | | | | | | | | | | | | | | | | | | | | | | | | | |
| 114 | - | - | - | - | 37,9 | - | 38,9 | 122 | - | - | - | - | 24,6 | - | - | - | - | - | - | - | - | 26,7 | | | | | | | | | | | | | | | | | | | | | | | | | |
| 118 | - | - | - | - | 37,9 | - | 34,8 | 126 | - | - | - | - | 24,6 | - | - | - | - | - | - | - | - | 26,1 | | | | | | | | | | | | | | | | | | | | | | | | | |
| 122 | - | - | - | - | - | - | 30,4 | 129 | - | - | - | - | 24,6 | - | - | - | - | - | - | - | - | 25,2 | | | | | | | | | | | | | | | | | | | | | | | | | |
| 126 | - | - | - | - | - | - | 26,2 | 130 | - | - | - | - | - | - | - | - | - | - | - | - | - | 24,9 | | | | | | | | | | | | | | | | | | | | | | | | | |
| 130 | - | - | - | - | - | - | 23,0 | 134 | - | - | - | - | - | - | - | - | - | - | - | - | - | 21,8 | | | | | | | | | | | | | | | | | | | | | | | | | |
| 134 | - | - | - | - | - | - | 19,2 | 138 | - | - | - | - | - | - | - | - | - | - | - | - | - | 19,2 | | | | | | | | | | | | | | | | | | | | | | | | | |
| 135 | - | - | - | - | - | - | 18,1 | 142 | - | - | - | - | - | - | - | - | - | - | - | - | - | 15,8 | | | | | | | | | | | | | | | | | | | | | | | | | |
| | | | | | | | | 146 | - | - | - | - | - | - | - | - | - | - | - | - | - | 12,1 | | | | | | | | | | | | | | | | | | | | | | | | | |
| | | | | | | | | 147 | - | - | - | - | - | - | - | - | - | - | - | - | - | 11,2 | | | | | | | | | | | | | | | | | | | | | | | | | |

0t 65t 125t 165t 205t 245t 285t 325t

* Main boom angle 85° · Hauptauslegerwinkel 85° · Jarret de flèche principale 85° · Inclinazione braccio base 85° · Ángulo de pluma principal 85° · Ángulo da lança principal 85° · Угол подъема гл. стрелы 85°

Main boom angle 87°, 85°, 75°, 65° and 55°, capacities for intermediate boom positions are calculated by the crane control system IC-1 · Hauptauslegerwinkel 87°, 85°, 75°, 65° und 55°, Traglasten für Zwischenstellungen des Hauptauslegers werden von der Kransteuerung IC-1 berechnet · Jarret de flèche principale 87°, 85°, 75°, 65° et 55°, le système de commande de la grue IC-1 calcule les charges pour les positions intermédiaires de la flèche · Inclinazione braccio base 87°, 85°, 75°, 65° e 55°, capacità per posizioni intermedie del braccio sono calcolate dal sistema di controllo della gru IC-1 · Ángulo de pluma principal 87°, 85°, 75°, 65° y 55°, las capacidades para posiciones de pluma intermedias son calculadas por el sistema de control de grúa IC-1 · Ángulos da lança principal 87°, 85°, 75°, 65° e 55°; as capacidades para posições da lança intermediária são calculadas pelo sistema de controle da grua IC-1 · Грузоподъемность при углах подъема главной стрелы 87°, 85°, 75°, 65° и 55°, грузоподъемность в промежуточных положениях стрелы рассчитывается системой управления краном IC-1

| 165 t + 50 t | | 11-19 m | | 8,40 m | | 9.8 m/s | | 360° | | ISO | |
|--------------|-------|---------|-------|--------|-------|-------------|---|------|------|-----|-------|
| 66 m + 24 m | | | | | | 66 m + 36 m | | | | | |
| SWSL_1 | | | | | | SWSL_1 | | | | | |
| 0 t | | | | | | 0 t-325 t | | | | | |
| 87°/85° | | 87°/85° | | 75° | | 65° | | 55° | | 15° | |
| m | t | t | t | t | t | t | t | t | t | t | t |
| 13 | 180,0 | 258,0 | - | - | - | - | - | - | - | - | - |
| 14 | 169,0 | 255,0 | - | - | - | - | - | - | - | - | - |
| 16 | 151,0 | 267,0* | - | - | - | - | - | - | - | - | - |
| 18 | 136,0 | 261,0* | - | - | - | - | - | - | - | - | - |
| 20 | 123,0 | 255,0* | - | - | - | - | - | - | - | - | - |
| 22 | 113,0 | 247,0* | - | - | - | - | - | - | - | - | - |
| 24 | 104,0 | 240,0* | - | - | - | - | - | - | - | - | - |
| 26 | 97,0 | 232,0* | - | - | - | - | - | - | - | - | - |
| 28 | 90,5 | 224,0* | - | - | - | - | - | - | - | - | - |
| 29 | 88,0 | 217,5* | - | - | - | - | - | - | - | - | - |
| 30 | 81,0* | 214,0* | - | - | - | - | - | - | - | - | - |
| 31 | 78,0* | 196,0* | - | - | - | - | - | - | - | - | - |
| 32 | - | - | 248,0 | - | - | - | - | - | - | - | - |
| 34 | - | - | 233,0 | - | - | - | - | - | - | - | - |
| 38 | - | - | 208,0 | - | - | - | - | - | - | - | - |
| 42 | - | - | 187,0 | - | - | - | - | - | - | - | - |
| 46 | - | - | - | - | - | - | - | - | - | - | - |
| 47 | - | - | - | 155,0 | - | - | - | - | - | - | - |
| 50 | - | - | - | 144,0 | - | - | - | - | - | - | - |
| 53 | - | - | - | 135,0 | - | - | - | - | - | - | - |
| 54 | - | - | - | - | - | - | - | - | - | - | - |
| 58 | - | - | - | - | - | - | - | - | - | - | - |
| 60 | - | - | - | - | 110,0 | - | - | - | - | - | - |
| 62 | - | - | - | - | 106,0 | - | - | - | - | - | - |
| 63 | - | - | - | - | 104,0 | - | - | - | - | - | - |
| 66 | - | - | - | - | - | - | - | - | - | - | - |
| 70 | - | - | - | - | - | - | - | - | - | - | - |
| 74 | - | - | - | - | - | - | - | - | - | - | - |
| 78 | - | - | - | - | - | - | - | - | - | - | - |
| 82 | - | - | - | - | - | - | - | - | - | - | - |
| 83 | - | - | - | - | - | - | - | - | - | - | - |
| 15 | 147,0 | 193,0 | - | - | - | - | - | - | - | - | - |
| 16 | 140,0 | 191,0 | - | - | - | - | - | - | - | - | - |
| 18 | 126,0 | 188,0 | - | - | - | - | - | - | - | - | - |
| 20 | 114,0 | 195,0* | - | - | - | - | - | - | - | - | - |
| 22 | 105,0 | 192,0* | - | - | - | - | - | - | - | - | 188,0 |
| 24 | 97,0 | 189,0* | - | - | - | - | - | - | - | - | 188,0 |
| 26 | 90,0 | 185,0* | - | - | - | - | - | - | - | - | 188,0 |
| 28 | 83,5 | 181,0* | - | - | - | - | - | - | - | - | 188,0 |
| 30 | 78,0 | 176,0* | - | - | - | - | - | - | - | - | 188,0 |
| 34 | 69,0 | 167,0* | - | - | - | - | - | - | - | - | 186,0 |
| 36 | 64,7 | 163,0* | 187,0 | - | - | - | - | - | - | - | 186,0 |
| 38 | 60,5 | 159,0* | 187,0 | - | - | - | - | - | - | - | 182,6 |
| 40 | 56,5 | 143,0* | 185,0 | - | - | - | - | - | - | - | 182,3 |
| 42 | 50,5* | 127,0* | 184,0 | - | - | - | - | - | - | - | 182,0 |
| 43 | 49,2* | 118,0* | 179,7 | - | - | - | - | - | - | - | 177,1 |
| 46 | - | - | 167,0 | - | - | - | - | - | - | - | 162,6 |
| 50 | - | - | 151,0 | - | - | - | - | - | - | - | 145,3 |
| 54 | - | - | 131,0 | 129,0 | - | - | - | - | - | - | 130,0 |
| 58 | - | - | - | 119,0 | - | - | - | - | - | - | 117,3 |
| 62 | - | - | - | 110,0 | - | - | - | - | - | - | 106,3 |
| 65 | - | - | - | 104,0 | - | - | - | - | - | - | 99,3 |
| 66 | - | - | - | - | - | - | - | - | - | - | 97,0 |
| 68 | - | - | - | - | - | - | - | - | 92,5 | - | 93,0 |
| 70 | - | - | - | - | - | - | - | - | 89,5 | - | 89,0 |
| 74 | - | - | - | - | - | - | - | - | 83,5 | - | 81,6 |
| 75 | - | - | - | - | - | - | - | - | 82,5 | - | 80,0 |
| 78 | - | - | - | - | - | - | - | - | - | - | 75,0 |
| 82 | - | - | - | - | - | - | - | - | - | - | 69,3 |
| 86 | - | - | - | - | - | - | - | - | - | - | 62,6 |
| 90 | - | - | - | - | - | - | - | - | - | - | 55,0 |
| 94 | - | - | - | - | - | - | - | - | - | - | 49,2 |

0 t 65 t 125 t 165 t 205 t 245 t 285 t 325 t

* Main boom angle 85° · Hauptauslegerwinkel 85° · Jarret de flèche principale 85° · Inclinazione braccio base 85° · Ángulo de pluma principal 85° · Ângulo da lança principal 85° · Угол подъема гл. стрелы 85°

Main boom angle 87°, 85°, 75°, 65° and 55°, capacities for intermediate boom positions are calculated by the crane control system IC-1 · Hauptauslegerwinkel 87°, 85°, 75°, 65° und 55°, Traglasten für Zwischenstellungen des Hauptauslegers werden von der Kransteuerung IC-1 berechnet · Jarret de flèche principale 87°, 85°, 75°, 65° et 55°, le système de commande de la grue IC-1 calcule les charges pour les positions intermédiaires de la flèche · Inclinazione braccio base 87°, 85°, 75°, 65° e 55°, capacità per posizioni intermedie del braccio sono calcolate dal sistema di controllo della gru IC-1 · Ángulo de pluma principal 87°, 85°, 75°, 65° y 55°, las capacidades para posiciones de pluma intermedias son calculadas por el sistema de control de grúa IC-1 · Ângulos da lança principal 87°, 85°, 75°, 65° e 55°; as capacidades para posições da lança intermediária são calculadas pelo sistema de controle da grua IC-1 · Грузоподъемность при углах подъема главной стрелы 87°, 85°, 75°, 65° и 55°, грузоподъемность в промежуточных положениях стрелы рассчитывается системой управления краном IC-1

| 165 t + 50 t | | | | | | | | 11-19 m | | 8,40 m | | 9.8 m/s | | 360° | | ISO | | | |
|--------------|-------|--------|-------|-------|------|---|-------|-----------|-------|--------|------|---------|------|------|---|-------|---|--|--|
| 66 m + 48 m | | | | | | | | | | | | | | | | | | | |
| SWSL_1 | | | | | | | | SFSL_1 | | | | | | | | | | | |
| 0 t | | | | | | | | 0 t-325 t | | | | | | | | | | | |
| 87°/85° | | | | | | | | 87°/85° | | 75° | | 65° | | 55° | | 15° | | | |
| m | t | t | t | t | t | t | t | m | t | t | t | t | t | t | t | t | t | | |
| 18 | 117,0 | 143,0 | - | - | - | - | - | 21 | 94,5 | 107,0 | - | - | - | - | - | - | - | | |
| 20 | 106,0 | 142,0 | - | - | - | - | - | 22 | 90,5 | 107,0 | - | - | - | - | - | - | - | | |
| 22 | 97,5 | 145,0* | - | - | - | - | - | 24 | 83,5 | 106,0 | - | - | - | - | - | - | - | | |
| 24 | 90,0 | 144,0* | - | - | - | - | - | 26 | 77,5 | 108,0* | - | - | - | - | - | - | - | | |
| 26 | 83,0 | 143,0* | - | - | - | - | 140,0 | 28 | 72,0 | 107,0* | - | - | - | - | - | - | - | | |
| 28 | 77,5 | 141,0* | - | - | - | - | 140,0 | 30 | 67,0 | 106,0* | - | - | - | - | - | 105,0 | - | | |
| 30 | 72,0 | 139,0* | - | - | - | - | 140,0 | 34 | 58,5 | 105,0* | - | - | - | - | - | 105,0 | - | | |
| 34 | 63,5 | 135,0* | - | - | - | - | 140,0 | 38 | 52,0 | 102,0* | - | - | - | - | - | 104,6 | - | | |
| 38 | 56,5 | 130,0* | - | - | - | - | 139,0 | 42 | 46,4 | 100,0* | - | - | - | - | - | 104,0 | - | | |
| 41 | 52,0 | 126,2* | 136,0 | - | - | - | 139,0 | 46 | 41,6 | 97,5* | 99,0 | - | - | - | - | 104,0 | - | | |
| 42 | 50,5 | 125,0* | 136,0 | - | - | - | 139,0 | 50 | 37,6 | 94,5* | 99,0 | - | - | - | - | 103,0 | - | | |
| 46 | 45,6 | 120,0* | 136,0 | - | - | - | 136,6 | 54 | 34,1 | 91,5* | 99,0 | - | - | - | - | 101,0 | - | | |
| 50 | 40,5 | 107,0* | 136,0 | - | - | - | 133,6 | 58 | 31,0 | 86,0* | 99,0 | - | - | - | - | 98,3 | - | | |
| 52 | 38,3 | 97,7* | 134,5 | - | - | - | 132,3 | 62 | 28,0 | 74,0* | 98,5 | - | - | - | - | 96,0 | - | | |
| 54 | 34,3* | 88,5* | 134,0 | - | - | - | 131,0 | 63 | 27,3 | 70,8* | 98,3 | - | - | - | - | 95,5 | - | | |
| 58 | - | - | 125,0 | - | - | - | 119,0 | 66 | 23,6* | 61,5* | 98,0 | 85,0 | - | - | - | 94,0 | - | | |
| 60 | - | - | 118,0 | 112,0 | - | - | 113,0 | 70 | - | - | 89,0 | 85,0 | - | - | - | 90,6 | - | | |
| 62 | - | - | 111,0 | 108,0 | - | - | 108,1 | 74 | - | - | 77,5 | 85,0 | - | - | - | 83,6 | - | | |
| 66 | - | - | 92,0 | 100,0 | - | - | 98,5 | 77 | - | - | 68,5 | 80,8 | - | - | - | 78,6 | - | | |
| 70 | - | - | - | 93,0 | - | - | 90,0 | 78 | - | - | - | 79,5 | - | - | - | 77,0 | - | | |
| 74 | - | - | - | 87,0 | - | - | 82,6 | 82 | - | - | - | 74,5 | - | - | - | 71,0 | - | | |
| 76 | - | - | - | 84,5 | - | - | 79,3 | 85 | - | - | - | 71,5 | 66,0 | - | - | 66,7 | - | | |
| 77 | - | - | - | - | 77,5 | - | 77,6 | 86 | - | - | - | 70,5 | 65,0 | - | - | 65,5 | - | | |
| 78 | - | - | - | - | 76,0 | - | 76,0 | 88 | - | - | - | 68,5 | 63,1 | - | - | 63,0 | - | | |
| 82 | - | - | - | - | 71,5 | - | 70,3 | 90 | - | - | - | - | 61,5 | - | - | 60,5 | - | | |
| 86 | - | - | - | - | 67,5 | - | 65,0 | 94 | - | - | - | - | 58,0 | - | - | 56,0 | - | | |
| 90 | - | - | - | - | - | - | 60,0 | 98 | - | - | - | - | 55,0 | - | - | 52,0 | - | | |
| 94 | - | - | - | - | - | - | 55,0 | 102 | - | - | - | - | - | - | - | 48,1 | - | | |
| 98 | - | - | - | - | - | - | 49,1 | 106 | - | - | - | - | - | - | - | 42,9 | - | | |
| 102 | - | - | - | - | - | - | 42,5 | 110 | - | - | - | - | - | - | - | 37,5 | - | | |
| 106 | - | - | - | - | - | - | 38,0 | 114 | - | - | - | - | - | - | - | 33,0 | - | | |
| | | | | | | | | 117 | - | - | - | - | - | - | - | 29,9 | - | | |

0 t 65 t 125 t 165 t 205 t 245 t 285 t 325 t

* Main boom angle 85° · Hauptauslegerwinkel 85° · Jarret de flèche principale 85° · Inclinação braccio base 85° · Ángulo de pluma principal 85° · Ângulo da lança principal 85° · Угол подъема гл. стрелы 85°

Main boom angle 87°, 85°, 75°, 65° and 55°, capacities for intermediate boom positions are calculated by the crane control system IC-1 · Hauptauslegerwinkel 87°, 85°, 75°, 65° und 55°, Traglasten für Zwischenstellungen des Hauptauslegers werden von der Kransteuerung IC-1 berechnet · Jarret de flèche principale 87°, 85°, 75°, 65° et 55°, le système de commande de la grue IC-1 calcule les charges pour les positions intermédiaires de la flèche · Inclinação braccio base 87°, 85°, 75°, 65° e 55°, capacità per posizioni intermedie del braccio sono calcolate dal sistema di controllo della gru IC-1 · Ángulo de pluma principal 87°, 85°, 75°, 65° y 55°, las capacidades para posiciones de pluma intermedias son calculadas por el sistema de control de grúa IC-1 · Ângulos da lança principal 87°, 85°, 75°, 65° e 55°, as capacidades para posições da lança intermediária são calculadas pelo sistema de controle da grua IC-1 · Грузоподъемность при углах подъема главной стрелы 87°, 85°, 75°, 65° и 55°, грузоподъемность в промежуточных положениях стрелы рассчитывается системой управления краном IC-1

| 165 t + 50 t | | | | | | | | 11-19 m | | | | | | | | 8,40 m | | | | | | | | 9.8 m/s | | | | | | | | 360° | | | | | | | | ISO | | | | | | | |
|--------------|-------|---------|------|-----------|------|------|------|-------------|------|-------|------|-----------|------|---------|---|--------|------|-------|------|------|------|------|--|---------|--|--|--|--|--|--|--|------|--|--|--|--|--|--|--|-----|--|--|--|--|--|--|--|
| 66 m + 72 m | | | | | | | | 66 m + 84 m | | | | | | | | | | | | | | | | | | | | | | | | | | | | | | | | | | | | | | | |
| SWSL_1 | | | | SFSL_1 | | | | SWSL_1 | | | | SFSL_1 | | | | | | | | | | | | | | | | | | | | | | | | | | | | | | | | | | | |
| 0 t | | | | 0 t-325 t | | | | 0 t | | | | 0 t-325 t | | | | | | | | | | | | | | | | | | | | | | | | | | | | | | | | | | | |
| 87°/85° | | 87°/85° | | 75° | | 65° | | 55° | | 15° | | 87°/85° | | 87°/85° | | 75° | | 65° | | 55° | | 15° | | | | | | | | | | | | | | | | | | | | | | | | | |
| m | t | t | t | t | t | t | t | m | t | t | t | t | t | t | t | m | t | t | t | t | t | t | | | | | | | | | | | | | | | | | | | | | | | | | |
| 24 | 77,5 | 80,5 | - | - | - | - | - | 26 | 58,5 | 60,0 | - | - | - | - | - | 26 | 58,5 | 60,0 | - | - | - | - | | | | | | | | | | | | | | | | | | | | | | | | | |
| 26 | 71,5 | 80,0 | - | - | - | - | - | 28 | 58,5 | 59,5 | - | - | - | - | - | 28 | 58,5 | 59,5 | - | - | - | - | | | | | | | | | | | | | | | | | | | | | | | | | |
| 28 | 66,5 | 81,0* | - | - | - | - | - | 30 | 57,0 | 59,0 | - | - | - | - | - | 30 | 57,0 | 59,0 | - | - | - | - | | | | | | | | | | | | | | | | | | | | | | | | | |
| 30 | 62,0 | 80,5* | - | - | - | - | - | 34 | 49,7 | 59,0* | - | - | - | - | - | 34 | 49,7 | 59,0* | - | - | - | - | | | | | | | | | | | | | | | | | | | | | | | | | |
| 34 | 54,0 | 80,0* | - | - | - | - | 79,0 | 38 | 43,5 | 58,5* | - | - | - | - | - | 38 | 43,5 | 58,5* | - | - | - | 58,0 | | | | | | | | | | | | | | | | | | | | | | | | | |
| 38 | 47,8 | 79,0* | - | - | - | - | 79,0 | 42 | 38,3 | 58,0* | - | - | - | - | - | 42 | 38,3 | 58,0* | - | - | - | 57,5 | | | | | | | | | | | | | | | | | | | | | | | | | |
| 42 | 42,4 | 77,5* | - | - | - | - | 79,0 | 46 | 33,9 | 57,0* | - | - | - | - | - | 46 | 33,9 | 57,0* | - | - | - | 57,1 | | | | | | | | | | | | | | | | | | | | | | | | | |
| 46 | 37,8 | 76,0* | - | - | - | - | 78,0 | 50 | 30,2 | 56,0* | - | - | - | - | - | 50 | 30,2 | 56,0* | - | - | - | 56,5 | | | | | | | | | | | | | | | | | | | | | | | | | |
| 50 | 33,9 | 74,5* | - | - | - | - | 77,0 | 54 | 26,9 | 55,0* | - | - | - | - | - | 54 | 26,9 | 55,0* | - | - | - | 55,5 | | | | | | | | | | | | | | | | | | | | | | | | | |
| 51 | 33,0 | 74,1* | 70,5 | - | - | - | 76,7 | 56 | 25,4 | 54,5* | 50,5 | - | - | - | - | 56 | 25,4 | 54,5* | 50,5 | - | - | 55,0 | | | | | | | | | | | | | | | | | | | | | | | | | |
| 54 | 30,5 | 73,0* | 70,5 | - | - | - | 76,0 | 58 | 24,0 | 54,0* | 50,5 | - | - | - | - | 58 | 24,0 | 54,0* | 50,5 | - | - | 54,5 | | | | | | | | | | | | | | | | | | | | | | | | | |
| 58 | 27,5 | 71,5* | 70,5 | - | - | - | 74,3 | 62 | 21,4 | 53,0* | 50,5 | - | - | - | - | 62 | 21,4 | 53,0* | 50,5 | - | - | 53,3 | | | | | | | | | | | | | | | | | | | | | | | | | |
| 62 | 24,8 | 69,5* | 70,5 | - | - | - | 72,6 | 66 | 19,1 | 52,0* | 50,5 | - | - | - | - | 66 | 19,1 | 52,0* | 50,5 | - | - | 52,0 | | | | | | | | | | | | | | | | | | | | | | | | | |
| 66 | 22,5 | 68,0* | 70,5 | - | - | - | 71,0 | 70 | 17,1 | 51,0* | 50,5 | - | - | - | - | 70 | 17,1 | 51,0* | 50,5 | - | - | 50,6 | | | | | | | | | | | | | | | | | | | | | | | | | |
| 70 | 20,5 | 62,5* | 70,5 | - | - | - | 69,2 | 74 | 15,3 | 50,0* | 50,5 | - | - | - | - | 74 | 15,3 | 50,0* | 50,5 | - | - | 49,4 | | | | | | | | | | | | | | | | | | | | | | | | | |
| 73 | 19,1 | 56,5* | 70,5 | 59,5 | - | - | 68,0 | 78 | 13,6 | 49,3* | 50,5 | - | - | - | - | 78 | 13,6 | 49,3* | 50,5 | - | - | 48,4 | | | | | | | | | | | | | | | | | | | | | | | | | |
| 74 | 18,7 | 54,5* | 70,5 | 59,5 | - | - | 67,6 | 80 | 12,8 | 47,8* | 50,5 | 41,7 | - | - | - | 80 | 12,8 | 47,8* | 50,5 | 41,7 | - | 47,7 | | | | | | | | | | | | | | | | | | | | | | | | | |
| 75 | 18,2 | 52,3* | 70,5 | 59,5 | - | - | 67,2 | 82 | 12,1 | 46,4* | 50,5 | 41,7 | - | - | - | 82 | 12,1 | 46,4* | 50,5 | 41,7 | - | 47,1 | | | | | | | | | | | | | | | | | | | | | | | | | |
| 77 | 15,6* | 48,1* | 70,5 | 59,5 | - | - | 66,4 | 86 | 10,8 | 40,4* | 50,5 | 41,7 | - | - | - | 86 | 10,8 | 40,4* | 50,5 | 41,7 | - | 45,9 | | | | | | | | | | | | | | | | | | | | | | | | | |
| 78 | - | - | 70,5 | 59,5 | - | - | 66,0 | 87 | 10,5 | 38,7* | 50,5 | 41,7 | - | - | - | 87 | 10,5 | 38,7* | 50,5 | 41,7 | - | 45,5 | | | | | | | | | | | | | | | | | | | | | | | | | |
| 82 | - | - | 65,5 | 59,5 | - | - | 63,8 | 89 | 8,3* | 35,5* | 50,5 | 41,7 | - | - | - | 89 | 8,3* | 35,5* | 50,5 | 41,7 | - | 44,9 | | | | | | | | | | | | | | | | | | | | | | | | | |
| 86 | - | - | 57,5 | 59,5 | - | - | 62,1 | 90 | - | - | 50,5 | 41,7 | - | - | - | 90 | - | - | 50,5 | 41,7 | - | 44,6 | | | | | | | | | | | | | | | | | | | | | | | | | |
| 89 | - | - | 51,0 | 59,5 | - | - | 60,9 | 94 | - | - | 49,0 | 41,7 | - | - | - | 94 | - | - | 49,0 | 41,7 | - | 43,3 | | | | | | | | | | | | | | | | | | | | | | | | | |
| 90 | - | - | - | 59,5 | - | - | 60,5 | 98 | - | - | 43,1 | 41,7 | - | - | - | 98 | - | - | 43,1 | 41,7 | - | 42,1 | | | | | | | | | | | | | | | | | | | | | | | | | |
| 93 | - | - | - | 59,5 | 51,0 | - | 57,5 | 100 | - | - | 40,0 | 41,7 | - | - | - | 100 | - | - | 40,0 | 41,7 | - | 41,6 | | | | | | | | | | | | | | | | | | | | | | | | | |
| 94 | - | - | - | 59,5 | 51,0 | 56,5 | 56,5 | 102 | - | - | - | 41,7 | 34,9 | - | - | 102 | - | - | - | 41,7 | 34,9 | 41,1 | | | | | | | | | | | | | | | | | | | | | | | | | |
| 98 | - | - | - | 57,5 | 51,0 | 52,0 | 52,0 | 106 | - | - | - | 41,6 | 34,8 | 40,0 | - | 106 | - | - | - | 41,6 | 34,8 | 40,0 | | | | | | | | | | | | | | | | | | | | | | | | | |
| 100 | - | - | - | 54,5 | 50,4 | 50,1 | 50,1 | 110 | - | - | - | 41,6 | 34,8 | 38,8 | - | 110 | - | - | - | 41,6 | 34,8 | 38,8 | | | | | | | | | | | | | | | | | | | | | | | | | |
| 102 | - | - | - | - | 49,9 | 48,2 | 48,2 | 111 | - | - | - | 41,6 | 34,8 | 38,5 | - | 111 | - | - | - | 41,6 | 34,8 | 38,5 | | | | | | | | | | | | | | | | | | | | | | | | | |
| 106 | - | - | - | - | 47,3 | 44,5 | 44,5 | 114 | - | - | - | - | 34,8 | 37,6 | - | 114 | - | - | - | - | 34,8 | 37,6 | | | | | | | | | | | | | | | | | | | | | | | | | |
| 110 | - | - | - | - | 44,9 | 40,9 | 40,9 | 118 | - | - | - | - | 34,8 | 34,6 | - | 118 | - | - | - | - | 34,8 | 34,6 | | | | | | | | | | | | | | | | | | | | | | | | | |
| 114 | - | - | - | - | - | 37,3 | 37,3 | 121 | - | - | - | - | 34,8 | 32,2 | - | 121 | - | - | - | - | 34,8 | 32,2 | | | | | | | | | | | | | | | | | | | | | | | | | |
| 118 | - | - | - | - | - | 32,6 | 32,6 | 122 | - | - | - | - | - | 31,3 | - | 122 | - | - | - | - | - | 31,3 | | | | | | | | | | | | | | | | | | | | | | | | | |
| 122 | - | - | - | - | - | 27,9 | 27,9 | 126 | - | - | - | - | - | 27,6 | - | 126 | - | - | - | - | - | 27,6 | | | | | | | | | | | | | | | | | | | | | | | | | |
| 126 | - | - | - | - | - | 25,1 | 25,1 | 130 | - | - | - | - | - | 23,6 | - | 130 | - | - | - | - | - | 23,6 | | | | | | | | | | | | | | | | | | | | | | | | | |
| 129 | - | - | - | - | - | 21,5 | 21,5 | 134 | - | - | - | - | - | 20,3 | - | 134 | - | - | - | - | - | 20,3 | | | | | | | | | | | | | | | | | | | | | | | | | |
| | | | | | | | | 138 | - | - | - | - | - | 17,3 | - | 138 | - | - | - | - | - | 17,3 | | | | | | | | | | | | | | | | | | | | | | | | | |
| | | | | | | | | 141 | - | - | - | - | - | 14,2 | - | 141 | - | - | - | - | - | 14,2 | | | | | | | | | | | | | | | | | | | | | | | | | |

0t 65t 125t 165t 205t 245t 285t 325t

* Main boom angle 85° · Hauptauslegerwinkel 85° · Jarret de flèche principale 85° · Inclinazione braccio base 85° · Ángulo de pluma principal 85° · Ángulo da lança principal 85° · Угол подъема гл. стрелы 85°

Main boom angle 87°, 85°, 75°, 65° and 55°, capacities for intermediate boom positions are calculated by the crane control system IC-1 · Hauptauslegerwinkel 87°, 85°, 75°, 65° und 55°, Traglasten für Zwischenstellungen des Hauptauslegers werden von der Kransteuerung IC-1 berechnet · Jarret de flèche principale 87°, 85°, 75°, 65° et 55°, le système de commande de la grue IC-1 calcule les charges pour les positions intermédiaires de la flèche · Inclinazione braccio base 87°, 85°, 75°, 65° e 55°, capacità per posizioni intermedie del braccio sono calcolate dal sistema di controllo della gru IC-1 · Ángulo de pluma principal 87°, 85°, 75°, 65° y 55°, las capacidades para posiciones de pluma intermedias son calculadas por el sistema de control de grúa IC-1 · Ângulos da lança principal 87°, 85°, 75°, 65° e 55°, as capacidades para posições da lança intermediária são calculadas pelo sistema de controle da grua IC-1 · Грузоподъемность при углах подъема главной стрелы 87°, 85°, 75°, 65° и 55°, грузоподъемность в промежуточных положениях стрелы рассчитывается системой управления краном IC-1

| 165 t + 50 t | | 11-19 m | | 8,40 m | | 9.8 m/s | | 360° | | ISO | |
|--------------|------|---------|------|--------|------|-------------|---|------|---|-----|---|
| 66 m + 96 m | | | | | | 72 m + 24 m | | | | | |
| SWSL_1 | | | | | | SWSL_1 | | | | | |
| 0 t | | | | | | 0 t-325 t | | | | | |
| 87°/85° | | 87°/85° | | 75° | | 65° | | 55° | | 15° | |
| m | t | t | t | t | t | t | t | t | t | t | t |
| 29 | 43,1 | 44,1 | - | - | - | - | - | - | - | - | - |
| 30 | 43,0 | 43,9 | - | - | - | - | - | - | - | - | - |
| 34 | 42,5 | 43,4* | - | - | - | - | - | - | - | - | - |
| 38 | 39,4 | 42,9* | - | - | - | - | - | - | - | - | - |
| 42 | 34,5 | 42,4* | - | - | - | - | - | - | - | - | - |
| 46 | 30,3 | 41,7* | - | - | - | - | - | - | - | - | - |
| 50 | 26,6 | 41,1* | - | - | - | - | - | - | - | - | - |
| 54 | 23,4 | 40,4* | - | - | - | - | - | - | - | - | - |
| 58 | 20,6 | 39,7* | - | - | - | - | - | - | - | - | - |
| 62 | 18,1 | 39,0* | 35,8 | - | - | - | - | - | - | - | - |
| 66 | 15,9 | 38,2* | 35,8 | - | - | - | - | - | - | - | - |
| 70 | 13,9 | 37,5* | 35,8 | - | - | - | - | - | - | - | - |
| 74 | 12,1 | 36,8* | 35,8 | - | - | - | - | - | - | - | - |
| 78 | 10,5 | 36,1* | 35,8 | - | - | - | - | - | - | - | - |
| 82 | 9,1 | 35,5* | 35,8 | - | - | - | - | - | - | - | - |
| 86 | 7,7 | 34,9* | 35,8 | - | - | - | - | - | - | - | - |
| 87 | 7,4 | 34,7* | 35,8 | 28,0 | - | - | - | - | - | - | - |
| 90 | 6,5 | 34,3* | 35,8 | 28,0 | - | - | - | - | - | - | - |
| 94 | 5,4 | 33,7* | 35,7 | 28,0 | - | - | - | - | - | - | - |
| 98 | 4,4 | 29,6* | 35,7 | 28,0 | - | - | - | - | - | - | - |
| 101 | - | 25,7* | 35,7 | 28,0 | - | - | - | - | - | - | - |
| 102 | - | - | 35,7 | 28,0 | - | - | - | - | - | - | - |
| 106 | - | - | 35,7 | 28,0 | - | - | - | - | - | - | - |
| 110 | - | - | 32,1 | 28,0 | 22,5 | - | - | - | - | - | - |
| 112 | - | - | 29,6 | 28,0 | 22,5 | - | - | - | - | - | - |
| 114 | - | - | - | 28,0 | 22,5 | - | - | - | - | - | - |
| 118 | - | - | - | 28,0 | 22,5 | - | - | - | - | - | - |
| 122 | - | - | - | 28,0 | 22,5 | - | - | - | - | - | - |
| 123 | - | - | - | 28,0 | 22,5 | - | - | - | - | - | - |
| 126 | - | - | - | - | 22,5 | - | - | - | - | - | - |
| 130 | - | - | - | - | 22,5 | - | - | - | - | - | - |
| 133 | - | - | - | - | 22,5 | - | - | - | - | - | - |
| 134 | - | - | - | - | - | - | - | - | - | - | - |
| 138 | - | - | - | - | - | - | - | - | - | - | - |
| 142 | - | - | - | - | - | - | - | - | - | - | - |
| 146 | - | - | - | - | - | - | - | - | - | - | - |
| 150 | - | - | - | - | - | - | - | - | - | - | - |
| 152 | - | - | - | - | - | - | - | - | - | - | - |

| 0 t | | 65 t | 125 t | 165 t | 205 t | 245 t | 285 t | 325 t |
|-----|--|------|-------|-------|-------|-------|-------|-------|
|-----|--|------|-------|-------|-------|-------|-------|-------|

* Main boom angle 85° · Hauptauslegerwinkel 85° · Jarret de flèche principale 85° · Inclinazione braccio base 85° · Ángulo de pluma principal 85° · Ângulo da lança principal 85° · Угол подъема гл. стрелы 85°

Main boom angle 87°, 85°, 75°, 65° and 55°, capacities for intermediate boom positions are calculated by the crane control system IC-1 · Hauptauslegerwinkel 87°, 85°, 75°, 65° und 55°, Traglasten für Zwischenstellungen des Hauptauslegers werden von der Kransteuerung IC-1 berechnet · Jarret de flèche principale 87°, 85°, 75°, 65° et 55°, le système de commande de la grue IC-1 calcule les charges pour les positions intermédiaires de la flèche · Inclinazione braccio base 87°, 85°, 75°, 65° e 55°, capacità per posizioni intermedie del braccio sono calcolate dal sistema di controllo della gru IC-1 · Ángulo de pluma principal 87°, 85°, 75°, 65° y 55°, las capacidades para posiciones de pluma intermedias son calculadas por el sistema de control de grúa IC-1 · Ângulos da lança principal 87°, 85°, 75°, 65° e 55°; as capacidades para posições da lança intermediária são calculadas pelo sistema de controle da grua IC-1 · Грузоподъемность при углах подъема главной стрелы 87°, 85°, 75°, 65° и 55°, грузоподъемность в промежуточных положениях стрелы рассчитывается системой управления краном IC-1

| 165 t + 50 t | | 11-19 m | | 8,40 m | | 9.8 m/s | | 360° | | ISO | |
|--------------|-------|-----------|-------|--------|------|-------------|-------|-----------|-------|-------|-------|
| 72 m + 36 m | | | | | | 72 m + 48 m | | | | | |
| SWSL_1 | | | | | | SWSL_1 | | | | | |
| SFSL_1 | | | | | | SFSL_1 | | | | | |
| 0 t | | 0 t-325 t | | | | 0 t | | 0 t-325 t | | | |
| 87°/85° | | 87°/85° | | 75° | | 65° | | 55° | | 15° | |
| m | t | t | t | t | t | m | t | t | t | t | t |
| 16 | 134,0 | 174,0 | - | - | - | 18 | 112,0 | 131,0 | - | - | - |
| 18 | 121,0 | 171,0 | - | - | - | 20 | 102,0 | 130,0 | - | - | - |
| 20 | 110,0 | 177,0* | - | - | - | 22 | 93,5 | 128,0 | - | - | - |
| 22 | 101,0 | 174,0* | - | - | - | 24 | 86,5 | 132,0* | - | - | - |
| 24 | 93,5 | 171,0* | - | - | - | 26 | 80,0 | 131,0* | - | - | - |
| 26 | 86,5 | 168,0* | - | - | - | 27 | 77,2 | 130,0* | - | - | 128,0 |
| 28 | 80,5 | 164,0* | - | - | - | 28 | 74,5 | 129,0* | - | - | 128,0 |
| 30 | 75,5 | 160,0* | - | - | - | 30 | 69,5 | 127,0* | - | - | 128,0 |
| 34 | 66,5 | 152,0* | - | - | - | 34 | 61,0 | 123,0* | - | - | 128,0 |
| 38 | 59,5 | 144,0* | 170,0 | - | - | 38 | 54,5 | 119,0* | - | - | 128,0 |
| 41 | 54,5 | 135,7* | 168,5 | - | - | 42 | 48,8 | 114,0* | - | - | 128,0 |
| 42 | 50,5* | 133,0* | 168,0 | - | - | 43 | 47,6 | 112,7* | 125,0 | - | 126,6 |
| 43 | 48,9* | 124,0* | 166,0 | - | - | 46 | 44,1 | 109,0* | 125,0 | - | 125,6 |
| 46 | - | - | 163,0 | - | - | 50 | 40,1 | 105,0* | 124,0 | - | 123,3 |
| 50 | - | - | 149,0 | - | - | 52 | 37,9 | 98,2* | 123,5 | - | 122,6 |
| 54 | - | - | 136,0 | - | - | 54 | 33,7* | 91,5* | 123,0 | - | 122,0 |
| 56 | - | - | 128,0 | 121,0 | - | 55 | 32,8* | 86,0* | 121,5 | - | 120,1 |
| 58 | - | - | - | 116,0 | - | 58 | - | - | 120,0 | - | 114,6 |
| 62 | - | - | - | 108,0 | - | 62 | - | - | 114,0 | - | 106,1 |
| 66 | - | - | - | 100,0 | - | 63 | - | - | 110,5 | 103,0 | 103,7 |
| 67 | - | - | - | 98,5 | - | 66 | - | - | 100,0 | 97,5 | 96,5 |
| 70 | - | - | - | - | - | 67 | - | - | 95,0 | 95,8 | 94,5 |
| 72 | - | - | - | - | 84,0 | 70 | - | - | - | 90,5 | 88,5 |
| 74 | - | - | - | - | 81,0 | 74 | - | - | - | 85,0 | 81,1 |
| 78 | - | - | - | - | 76,0 | 78 | - | - | - | 79,5 | 74,5 |
| 82 | - | - | - | - | - | 79 | - | - | - | 78,5 | 73,0 |
| 86 | - | - | - | - | - | 80 | - | - | - | - | 71,0 |
| 90 | - | - | - | - | - | 82 | - | - | - | - | 68,5 |
| 94 | - | - | - | - | - | 86 | - | - | - | - | 65,0 |
| 98 | - | - | - | - | - | 90 | - | - | - | - | 61,5 |
| 99 | - | - | - | - | - | 94 | - | - | - | - | 53,8 |
| | | | | | | 98 | - | - | - | - | 49,2 |
| | | | | | | 102 | - | - | - | - | 44,7 |
| | | | | | | 106 | - | - | - | - | 38,5 |
| | | | | | | 110 | - | - | - | - | 33,5 |
| | | | | | | 111 | - | - | - | - | 32,7 |

0 t 65 t 125 t 165 t 205 t 245 t 285 t 325 t

* Main boom angle 85° · Hauptauslegerwinkel 85° ·
 Jarret de flèche principale 85° · Inclinazione braccio base 85° ·
 Ângulo de pluma principal 85° · Ângulo da lança principal 85° · Угол подъема гл. стрелы 85°

Main boom angle 87°, 85°, 75°, 65° and 55°, capacities for intermediate boom positions are calculated by the crane control system IC-1 · Hauptauslegerwinkel 87°, 85°, 75°, 65° und 55°, Traglasten für Zwischenstellungen des Hauptauslegers werden von der Kransteuerung IC-1 berechnet · Jarret de flèche principale 87°, 85°, 75°, 65° et 55°, le système de commande de la grue IC-1 calcule les charges pour les positions intermédiaires de la flèche · Inclinazione braccio base 87°, 85°, 75°, 65° e 55°, capacità per posizioni intermedie del braccio sono calcolate dal sistema di controllo della gru IC-1 · Ângulo de pluma principal 87°, 85°, 75°, 65° y 55°, las capacidades para posiciones de pluma intermedias son calculadas por el sistema de control de grúa IC-1 · Ângulos da lança principal 87°, 85°, 75°, 65° e 55°; as capacidades para posições da lança intermediária são calculadas pelo sistema de controle da grua IC-1 · Грузоподъемность при углах подъема главной стрелы 87°, 85°, 75°, 65° и 55°, грузоподъемность в промежуточных положениях стрелы рассчитывается системой управления краном IC-1

| 165 t + 50 t | | 11-19 m | | 8,40 m | | 9.8 m/s | | 360° | | ISO | |
|--------------|-------|-----------|------|-----------|------|-------------|---|-----------|---|-----------|------|
| 72 m + 60 m | | SWSL_1 | | SFSL_1 | | 72 m + 72 m | | SWSL_1 | | SFSL_1 | |
| 0 t | | 0 t-325 t | | 0 t-325 t | | 0 t | | 0 t-325 t | | 0 t-325 t | |
| 87°/85° | | 87°/85° | | 75° | | 65° | | 55° | | 15° | |
| m | t | t | t | t | t | t | t | t | t | t | t |
| 21 | 91,0 | 99,5 | - | - | - | - | - | - | - | - | - |
| 22 | 87,0 | 99,0 | - | - | - | - | - | - | - | - | - |
| 24 | 80,5 | 98,0 | - | - | - | - | - | - | - | - | - |
| 26 | 74,5 | 100,0* | - | - | - | - | - | - | - | - | - |
| 28 | 69,0 | 99,5* | - | - | - | - | - | - | - | - | - |
| 30 | 64,5 | 98,5* | - | - | - | - | - | - | - | - | - |
| 31 | 62,5 | 98,1* | - | - | - | - | - | - | - | 97,0 | 97,0 |
| 34 | 56,5 | 97,0* | - | - | - | - | - | - | - | 97,0 | 97,0 |
| 38 | 50,0 | 94,5* | - | - | - | - | - | - | - | 96,8 | 96,8 |
| 42 | 44,7 | 92,0* | - | - | - | - | - | - | - | 96,5 | 96,5 |
| 46 | 40,1 | 89,5* | - | - | - | - | - | - | - | 96,1 | 96,1 |
| 48 | 38,1 | 88,0* | 91,5 | - | - | - | - | - | - | 96,0 | 96,0 |
| 50 | 36,1 | 86,5* | 91,5 | - | - | - | - | - | - | 94,8 | 94,8 |
| 54 | 32,8 | 83,5* | 91,5 | - | - | - | - | - | - | 93,5 | 93,5 |
| 58 | 29,8 | 81,0* | 91,5 | - | - | - | - | - | - | 91,8 | 91,8 |
| 62 | 27,3 | 75,5* | 91,5 | - | - | - | - | - | - | 89,6 | 89,6 |
| 64 | 26,2 | 69,5* | 91,0 | - | - | - | - | - | - | 88,8 | 88,8 |
| 66 | 22,7* | 63,5* | 91,0 | - | - | - | - | - | - | 88,0 | 88,0 |
| 69 | - | - | 89,8 | 79,0 | - | - | - | - | - | 86,0 | 86,0 |
| 70 | - | - | 89,5 | 79,0 | - | - | - | - | - | 85,5 | 85,5 |
| 74 | - | - | 82,0 | 78,5 | - | - | - | - | - | 81,5 | 81,5 |
| 78 | - | - | 70,0 | 77,5 | - | - | - | - | - | 75,5 | 75,5 |
| 79 | - | - | 67,0 | 76,2 | - | - | - | - | - | 74,0 | 74,0 |
| 82 | - | - | - | 72,5 | - | - | - | - | - | 69,5 | 69,5 |
| 86 | - | - | - | 68,5 | - | - | - | - | - | 64,0 | 64,0 |
| 89 | - | - | - | 65,5 | 60,0 | - | - | - | - | 60,2 | 60,2 |
| 90 | - | - | - | 64,5 | 59,0 | - | - | - | - | 59,0 | 59,0 |
| 91 | - | - | - | 64,0 | 58,1 | - | - | - | - | 57,8 | 57,8 |
| 94 | - | - | - | - | 55,5 | 54,3 | - | - | - | 54,3 | 54,3 |
| 98 | - | - | - | - | 52,5 | 50,1 | - | - | - | 50,1 | 50,1 |
| 101 | - | - | - | - | 50,5 | 47,2 | - | - | - | 47,2 | 47,2 |
| 102 | - | - | - | - | - | 46,3 | - | - | - | 46,3 | 46,3 |
| 106 | - | - | - | - | - | 42,6 | - | - | - | 42,6 | 42,6 |
| 110 | - | - | - | - | - | 38,6 | - | - | - | 38,6 | 38,6 |
| 114 | - | - | - | - | - | 33,7 | - | - | - | 33,7 | 33,7 |
| 118 | - | - | - | - | - | 28,6 | - | - | - | 28,6 | 28,6 |
| 122 | - | - | - | - | - | 25,1 | - | - | - | 25,1 | 25,1 |
| 123 | - | - | - | - | - | 24,2 | - | - | - | 24,2 | 24,2 |
| 24 | 73,0 | 75,0 | - | - | - | - | - | - | - | 72,5 | 72,5 |
| 26 | 69,0 | 74,5 | - | - | - | - | - | - | - | 72,5 | 72,5 |
| 28 | 64,0 | 74,0 | - | - | - | - | - | - | - | 71,8 | 71,8 |
| 30 | 59,5 | 75,0* | - | - | - | - | - | - | - | 71,0 | 71,0 |
| 34 | 52,0 | 74,0* | - | - | - | - | - | - | - | 70,2 | 70,2 |
| 35 | 50,4 | 73,7* | - | - | - | - | - | - | - | 70,2 | 70,2 |
| 38 | 45,9 | 73,0* | - | - | - | - | - | - | - | 70,0 | 70,0 |
| 42 | 40,7 | 72,0* | - | - | - | - | - | - | - | 70,0 | 70,0 |
| 46 | 36,3 | 70,5* | - | - | - | - | - | - | - | 68,6 | 68,6 |
| 50 | 32,5 | 69,0* | - | - | - | - | - | - | - | 67,4 | 67,4 |
| 53 | 30,0 | 67,8* | 65,5 | - | - | - | - | - | - | 66,0 | 66,0 |
| 54 | 29,2 | 67,5* | 65,5 | - | - | - | - | - | - | 64,6 | 64,6 |
| 58 | 26,3 | 65,5* | 65,5 | - | - | - | - | - | - | 62,8 | 62,8 |
| 62 | 23,7 | 64,0* | 65,5 | - | - | - | - | - | - | 62,5 | 62,5 |
| 66 | 21,5 | 62,0* | 65,5 | - | - | - | - | - | - | 62,1 | 62,1 |
| 70 | 19,5 | 60,5* | 65,5 | - | - | - | - | - | - | 61,5 | 61,5 |
| 74 | 17,7 | 55,5* | 65,5 | - | - | - | - | - | - | 59,8 | 59,8 |
| 75 | 17,3 | 53,4* | 65,5 | - | - | - | - | - | - | 58,3 | 58,3 |
| 76 | 14,8* | 51,3* | 65,5 | 55,5 | - | - | - | - | - | 57,0 | 57,0 |
| 78 | 14,1* | 47,1* | 65,5 | 55,5 | - | - | - | - | - | 54,1 | 54,1 |
| 82 | - | - | 65,5 | 55,5 | - | - | - | - | - | 51,4 | 51,4 |
| 86 | - | - | 60,5 | 55,5 | - | - | - | - | - | 50,4 | 50,4 |
| 90 | - | - | 52,5 | 55,5 | - | - | - | - | - | 47,6 | 47,6 |
| 94 | - | - | - | 55,5 | 47,6 | - | - | - | - | 46,4 | 46,4 |
| 97 | - | - | - | 55,5 | 47,6 | - | - | - | - | 42,7 | 42,7 |
| 98 | - | - | - | 55,5 | 47,6 | - | - | - | - | 39,2 | 39,2 |
| 102 | - | - | - | 53,0 | 47,2 | - | - | - | - | 36,8 | 36,8 |
| 106 | - | - | - | - | 44,7 | - | - | - | - | 36,0 | 36,0 |
| 110 | - | - | - | - | 42,4 | - | - | - | - | 32,7 | 32,7 |
| 113 | - | - | - | - | 40,8 | - | - | - | - | 28,9 | 28,9 |
| 114 | - | - | - | - | - | - | - | - | - | 24,6 | 24,6 |
| 118 | - | - | - | - | - | - | - | - | - | 20,9 | 20,9 |
| 122 | - | - | - | - | - | - | - | - | - | 17,7 | 17,7 |
| 134 | - | - | - | - | - | - | - | - | - | - | - |

0 t 65 t 125 t 165 t 205 t 245 t 285 t 325 t

* Main boom angle 85° · Hauptauslegerwinkel 85° · Jarret de flèche principale 85° · Inclinazione braccio base 85° · Ángulo de pluma principal 85° · Ângulo da lança principal 85° · Угол подъема гл. стрелы 85°

Main boom angle 87°, 85°, 75°, 65° and 55°, capacities for intermediate boom positions are calculated by the crane control system IC-1 · Hauptauslegerwinkel 87°, 85°, 75°, 65° und 55°, Traglasten für Zwischenstellungen des Hauptauslegers werden von der Kransteuerung IC-1 berechnet · Jarret de flèche principale 87°, 85°, 75°, 65° et 55°, le système de commande de la grue IC-1 calcule les charges pour les positions intermédiaires de la flèche · Inclinazione braccio base 87°, 85°, 75°, 65° e 55°, capacità per posizioni intermedie del braccio sono calcolate dal sistema di controllo della gru IC-1 · Ángulo de pluma principal 87°, 85°, 75°, 65° y 55°, las capacidades para posiciones de pluma intermedias son calculadas por el sistema de control de grúa IC-1 · Ângulos da lança principal 87°, 85°, 75°, 65° e 55°; as capacidades para posições da lança intermediária são calculadas pelo sistema de controle da grua IC-1 · Грузоподъемность при углах подъема главной стрелы 87°, 85°, 75°, 65° и 55°, грузоподъемность в промежуточных положениях стрелы рассчитывается системой управления краном IC-1

| 165 t + 50 t | | | | | | | | 11-19 m | | 8,40 m | | 9.8 m/s | | 360° | | ISO | | | |
|--------------|------|-------|------|------|------|---|------|-----------|------|--------|------|---------|------|------|---|------|---|--|--|
| 72 m + 84 m | | | | | | | | | | | | | | | | | | | |
| SWSL_1 | | | | | | | | SFSL_1 | | | | | | | | | | | |
| 0 t | | | | | | | | 0 t-325 t | | | | | | | | | | | |
| 87°/85° | | | | | | | | 87°/85° | | 75° | | 65° | | 55° | | 15° | | | |
| m | t | t | t | t | t | t | t | m | t | t | t | t | t | t | t | t | t | | |
| 27 | 54,5 | 56,0 | - | - | - | - | - | 29 | 40,5 | 41,4 | - | - | - | - | - | - | - | | |
| 28 | 54,5 | 55,5 | - | - | - | - | - | 30 | 40,4 | 41,3 | - | - | - | - | - | - | - | | |
| 30 | 53,5 | 55,5 | - | - | - | - | - | 34 | 40,0 | 40,7 | - | - | - | - | - | - | - | | |
| 34 | 47,6 | 55,0* | - | - | - | - | - | 38 | 37,6 | 40,4* | - | - | - | - | - | - | - | | |
| 38 | 41,6 | 54,5* | - | - | - | - | - | 42 | 32,8 | 40,1* | - | - | - | - | - | - | - | | |
| 39 | 40,3 | 54,3* | - | - | - | - | 54,0 | 43 | 31,7 | 39,9* | - | - | - | - | - | 39,7 | - | | |
| 42 | 36,7 | 54,0* | - | - | - | - | 54,0 | 46 | 28,7 | 39,5* | - | - | - | - | - | 39,3 | - | | |
| 46 | 32,4 | 53,0* | - | - | - | - | 53,6 | 50 | 25,2 | 38,9* | - | - | - | - | - | 38,8 | - | | |
| 50 | 28,7 | 52,5* | - | - | - | - | 53,0 | 54 | 22,1 | 38,3* | - | - | - | - | - | 38,4 | - | | |
| 54 | 25,6 | 51,5* | - | - | - | - | 52,0 | 58 | 19,4 | 37,6* | - | - | - | - | - | 37,6 | - | | |
| 58 | 22,8 | 50,5* | 47,6 | - | - | - | 51,3 | 62 | 17,0 | 36,9* | - | - | - | - | - | 36,8 | - | | |
| 62 | 20,3 | 49,6* | 47,6 | - | - | - | 50,4 | 63 | 16,4 | 36,7* | 33,4 | - | - | - | - | 36,6 | - | | |
| 66 | 18,1 | 48,6* | 47,6 | - | - | - | 49,4 | 66 | 14,9 | 36,2* | 33,4 | - | - | - | - | 36,1 | - | | |
| 70 | 16,1 | 47,5* | 47,6 | - | - | - | 48,2 | 70 | 13,0 | 35,5* | 33,4 | - | - | - | - | 35,1 | - | | |
| 74 | 14,3 | 46,4* | 47,6 | - | - | - | 47,1 | 74 | 11,2 | 34,9* | 33,4 | - | - | - | - | 34,2 | - | | |
| 78 | 12,7 | 45,4* | 47,6 | - | - | - | 46,0 | 78 | 9,6 | 34,2* | 33,4 | - | - | - | - | 33,3 | - | | |
| 82 | 11,3 | 44,4* | 47,6 | 38,9 | - | - | 44,9 | 82 | 8,2 | 33,5* | 33,4 | - | - | - | - | 32,4 | - | | |
| 86 | 10,0 | 41,8* | 47,6 | 38,9 | - | - | 43,7 | 86 | 6,9 | 32,9* | 33,4 | - | - | - | - | 31,5 | - | | |
| 87 | 9,7 | 40,2* | 47,6 | 38,9 | - | - | 43,4 | 89 | 6,0 | 32,4* | 33,4 | 26,1 | - | - | - | 30,9 | - | | |
| 89 | 7,3* | 37,0* | 47,6 | 38,9 | - | - | 42,8 | 90 | 5,7 | 32,3* | 33,4 | 26,1 | - | - | - | 30,7 | - | | |
| 90 | - | - | 47,6 | 38,9 | - | - | 42,6 | 94 | 4,6 | 31,8* | 33,4 | 26,1 | - | - | - | 29,8 | - | | |
| 94 | - | - | 47,6 | 38,9 | - | - | 41,5 | 96 | 4,1 | 31,0* | 33,4 | 26,1 | - | - | - | 29,4 | - | | |
| 98 | - | - | 46,1 | 38,9 | - | - | 40,4 | 98 | - | 30,3* | 33,4 | 26,1 | - | - | - | 29,0 | - | | |
| 102 | - | - | 39,8 | 38,9 | - | - | 39,4 | 99 | - | 29,0* | 33,4 | 26,1 | - | - | - | 28,8 | - | | |
| 105 | - | - | - | 38,9 | 32,6 | - | 38,5 | 101 | - | 26,6* | 33,4 | 26,1 | - | - | - | 28,4 | - | | |
| 106 | - | - | - | 38,9 | 32,6 | - | 38,2 | 102 | - | - | 33,4 | 26,1 | - | - | - | 28,2 | - | | |
| 110 | - | - | - | 38,9 | 32,6 | - | 37,3 | 106 | - | - | 33,4 | 26,1 | - | - | - | 27,3 | - | | |
| 114 | - | - | - | 38,8 | 32,6 | - | 36,2 | 110 | - | - | 33,4 | 26,1 | - | - | - | 26,5 | - | | |
| 118 | - | - | - | - | 32,5 | - | 33,2 | 113 | - | - | 30,4 | 26,1 | - | - | - | 25,9 | - | | |
| 122 | - | - | - | - | 32,5 | - | 30,4 | 114 | - | - | - | 26,1 | 20,9 | - | - | 25,8 | - | | |
| 125 | - | - | - | - | 32,5 | - | 28,4 | 118 | - | - | - | 26,1 | 20,9 | 20,9 | - | 25,0 | - | | |
| 126 | - | - | - | - | - | - | 27,7 | 122 | - | - | - | 26,1 | 20,9 | 20,9 | - | 24,2 | - | | |
| 130 | - | - | - | - | - | - | 24,3 | 125 | - | - | - | 26,1 | 20,8 | 20,8 | - | 23,7 | - | | |
| 134 | - | - | - | - | - | - | 20,8 | 126 | - | - | - | - | 20,8 | 20,8 | - | 23,6 | - | | |
| 138 | - | - | - | - | - | - | 17,1 | 130 | - | - | - | - | 20,8 | 20,8 | - | 23,0 | - | | |
| 142 | - | - | - | - | - | - | 14,2 | 134 | - | - | - | - | 20,8 | 20,8 | - | 21,7 | - | | |
| 146 | - | - | - | - | - | - | 11,1 | 136 | - | - | - | - | 20,8 | 20,8 | - | 20,8 | - | | |
| | | | | | | | | 138 | - | - | - | - | - | - | - | 19,6 | - | | |
| | | | | | | | | 142 | - | - | - | - | - | - | - | 16,3 | - | | |
| | | | | | | | | 146 | - | - | - | - | - | - | - | 13,0 | - | | |
| | | | | | | | | 150 | - | - | - | - | - | - | - | 10,5 | - | | |
| | | | | | | | | 154 | - | - | - | - | - | - | - | 7,8 | - | | |
| | | | | | | | | 157 | - | - | - | - | - | - | - | 5,5 | - | | |

* Main boom angle 85° · Hauptauslegerwinkel 85° · Jarret de flèche principale 85° · Inclinazione braccio base 85° · Ángulo de pluma principal 85° · Ângulo da lança principal 85° · Угол подъема гл. стрелы 85°

Main boom angle 87°, 85°, 75°, 65° and 55°, capacities for intermediate boom positions are calculated by the crane control system IC-1 · Hauptauslegerwinkel 87°, 85°, 75°, 65° und 55°, Traglasten für Zwischenstellungen des Hauptauslegers werden von der Kransteuerung IC-1 berechnet · Jarret de flèche principale 87°, 85°, 75°, 65° et 55°, le système de commande de la grue IC-1 calcule les charges pour les positions intermédiaires de la flèche · Inclinazione braccio base 87°, 85°, 75°, 65° e 55°, capacità per posizioni intermedie del braccio sono calcolate dal sistema di controllo della gru IC-1 · Ángulo de pluma principal 87°, 85°, 75°, 65° y 55°, las capacidades para posiciones de pluma intermedias son calculadas por el sistema de control de grúa IC-1 · Ângulos da lança principal 87°, 85°, 75°, 65° e 55°; as capacidades para posições da lança intermediária são calculadas pelo sistema de controle da grua IC-1 · Грузоподъемность при углах подъема главной стрелы 87°, 85°, 75°, 65° и 55°, грузоподъемность в промежуточных положениях стрелы рассчитывается системой управления краном IC-1

| 165 t + 50 t | | 11-19 m | | 8,40 m | | 9.8 m/s | | 360° | | ISO | |
|--------------|-------|---------|-------|--------|------|-------------|-------|--------|-------|-------|-------|
| 78 m + 24 m | | | | | | 78 m + 36 m | | | | | |
| SWSL_1 | | | | | | SWSL_1 | | | | | |
| 0 t | | | | | | 0 t-325 t | | | | | |
| 87°/85° | | 87°/85° | | 75° | | 65° | | 55° | | 15° | |
| m | t | t | t | t | t | m | t | t | t | t | t |
| 13 | 165,0 | 195,0 | - | - | - | 16 | 128,0 | 146,0 | - | - | - |
| 14 | 155,0 | 192,0 | - | - | - | 18 | 116,0 | 143,0 | - | - | - |
| 16 | 139,0 | 187,0 | - | - | - | 20 | 106,0 | 148,0* | - | - | - |
| 18 | 126,0 | 194,0* | - | - | - | 22 | 97,5 | 145,0* | - | - | - |
| 19 | 120,0 | 192,0* | - | - | - | 23 | 93,7 | 143,5* | - | - | 142,0 |
| 20 | 114,0 | 189,0* | - | - | - | 24 | 90,0 | 142,0* | - | - | 142,0 |
| 22 | 105,0 | 183,0* | - | - | - | 26 | 83,5 | 139,0* | - | - | 142,0 |
| 24 | 97,5 | 177,0* | - | - | - | 28 | 78,0 | 135,0* | - | - | 142,0 |
| 26 | 90,5 | 171,0* | - | - | - | 30 | 73,0 | 132,0* | - | - | 142,0 |
| 28 | 84,5 | 165,0* | - | - | - | 34 | 64,5 | 124,0* | - | - | 140,0 |
| 29 | 82,0 | 162,5* | - | - | - | 38 | 57,5 | 117,0* | - | - | 138,3 |
| 30 | 74,5* | 160,0* | - | - | - | 39 | 56,1 | 115,5* | 138,0 | - | 138,0 |
| 32 | 70,0* | 155,0* | - | - | - | 41 | 53,5 | 112,5* | 138,0 | - | 137,3 |
| 34 | - | - | 184,0 | - | - | 42 | 48,6* | 111,0* | 137,0 | - | 137,0 |
| 38 | - | - | 178,0 | - | - | 44 | 46,4* | 108,0* | 135,0 | - | 134,6 |
| 42 | - | - | 169,0 | - | - | 46 | - | - | 133,0 | - | 133,3 |
| 46 | - | - | 157,0 | - | - | 50 | - | - | 127,0 | - | 129,3 |
| 50 | - | - | - | - | - | 54 | - | - | 120,0 | - | 126,0 |
| 52 | - | - | - | 133,0 | - | 57 | - | - | 115,0 | - | 118,0 |
| 54 | - | - | - | 127,0 | - | 58 | - | - | - | 115,0 | 115,3 |
| 58 | - | - | - | 117,0 | - | 62 | - | - | - | 106,0 | 105,0 |
| 62 | - | - | - | - | - | 66 | - | - | - | 98,5 | 95,5 |
| 66 | - | - | - | - | - | 70 | - | - | - | 92,0 | 87,5 |
| 67 | - | - | - | - | 91,5 | 74 | - | - | - | - | 80,0 |
| 70 | - | - | - | - | 87,0 | 75 | - | - | - | - | 78,2 |
| 74 | - | - | - | - | - | 78 | - | - | - | - | 73,0 |
| 78 | - | - | - | - | - | 82 | - | - | - | - | 70,0 |
| 82 | - | - | - | - | - | 86 | - | - | - | - | 62,1 |
| 86 | - | - | - | - | - | 90 | - | - | - | - | 57,0 |
| 90 | - | - | - | - | - | 94 | - | - | - | - | 52,3 |
| 93 | - | - | - | - | - | 98 | - | - | - | - | 46,8 |
| | | | | | | 102 | - | - | - | - | 40,6 |
| | | | | | | 105 | - | - | - | - | 36,4 |

0 t 65 t 125 t 165 t 205 t 245 t 285 t 325 t

* Main boom angle 85° · Hauptauslegerwinkel 85° · Jarret de flèche principale 85° · Inclinazione braccio base 85° · Ángulo de pluma principal 85° · Ângulo da lança principal 85° · Угол подъема гл. стрелы 85°

Main boom angle 87°, 85°, 75°, 65° and 55°, capacities for intermediate boom positions are calculated by the crane control system IC-1 · Hauptauslegerwinkel 87°, 85°, 75°, 65° und 55°, Traglasten für Zwischenstellungen des Hauptauslegers werden von der Kransteuerung IC-1 berechnet · Jarret de flèche principale 87°, 85°, 75°, 65° et 55°, le système de commande de la grue IC-1 calcule les charges pour les positions intermédiaires de la flèche · Inclinazione braccio base 87°, 85°, 75°, 65° e 55°, capacità per posizioni intermedie del braccio sono calcolate dal sistema di controllo della gru IC-1 · Ángulo de pluma principal 87°, 85°, 75°, 65° y 55°, las capacidades para posiciones de pluma intermedias son calculadas por el sistema de control de grúa IC-1 · Ângulos da lança principal 87°, 85°, 75°, 65° e 55°; as capacidades para posições da lança intermediária são calculadas pelo sistema de controle da grua IC-1 · Грузоподъемность при углах подъема главной стрелы 87°, 85°, 75°, 65° и 55°, грузоподъемность в промежуточных положениях стрелы рассчитывается системой управления краном IC-1

| 165 t + 50 t | | 11-19 m | | 8,40 m | | 9.8 m/s | | 360° | | ISO | |
|--------------|-------|-----------|-------|--------|------|-------------|-------|-----------|------|------|------|
| 78 m + 48 m | | | | | | 78 m + 60 m | | | | | |
| SWSL_1 | | | | | | SWSL_1 | | | | | |
| SFSL_1 | | | | | | SFSL_1 | | | | | |
| 0 t | | 0 t-325 t | | | | 0 t | | 0 t-325 t | | | |
| 87°/85° | | 87°/85° | | 75° | | 65° | | 55° | | 15° | |
| m | t | t | t | t | t | m | t | t | t | t | t |
| 19 | 103,0 | 111,0 | - | - | - | 21 | 83,5 | 85,5 | - | - | - |
| 20 | 98,5 | 110,0 | - | - | - | 22 | 82,5 | 85,0 | - | - | - |
| 22 | 90,5 | 108,0 | - | - | - | 24 | 77,5 | 84,0 | - | - | - |
| 24 | 83,5 | 112,0* | - | - | - | 26 | 71,5 | 85,5* | - | - | - |
| 26 | 77,5 | 111,0* | - | - | - | 28 | 66,5 | 85,0* | - | - | - |
| 27 | 74,7 | 110,0* | - | - | - | 30 | 62,0 | 84,0* | - | - | - |
| 28 | 72,0 | 109,0* | - | - | - | 31 | 60,1 | 83,5* | - | - | 82,5 |
| 30 | 67,0 | 107,0* | - | - | - | 34 | 54,5 | 82,0* | - | - | 82,5 |
| 34 | 59,0 | 103,0* | - | - | - | 38 | 48,4 | 80,0* | - | - | 82,3 |
| 38 | 52,5 | 98,5* | - | - | - | 42 | 43,1 | 77,0* | - | - | 82,0 |
| 42 | 47,2 | 94,0* | - | - | - | 46 | 38,7 | 74,5* | - | - | 81,0 |
| 45 | 43,8 | 90,6* | 104,0 | - | - | 49 | 35,8 | 72,2* | 78,0 | - | 80,2 |
| 46 | 42,7 | 89,5* | 104,0 | - | - | 50 | 34,9 | 71,5* | 78,0 | - | 80,0 |
| 50 | 38,8 | 86,0* | 103,0 | - | - | 54 | 31,6 | 68,5* | 78,0 | - | 79,0 |
| 52 | 37,1 | 84,2* | 101,5 | - | - | 58 | 28,7 | 66,0* | 78,0 | - | 77,6 |
| 54 | 32,5* | 82,5* | 100,0 | - | - | 62 | 26,2 | 63,5* | 77,0 | - | 76,0 |
| 55 | 31,8* | 81,5* | 99,3 | - | - | 64 | 25,1 | 62,5* | 76,0 | - | 75,0 |
| 58 | - | - | 97,5 | - | - | 66 | 21,6* | 61,5* | 75,0 | - | 74,0 |
| 62 | - | - | 94,0 | - | - | 67 | 21,1* | 61,0* | 74,5 | - | 73,5 |
| 65 | - | - | 90,8 | 89,5 | - | 70 | - | - | 73,0 | - | 72,0 |
| 66 | - | - | 90,0 | 89,5 | - | 72 | - | - | 71,7 | 65,5 | 71,0 |
| 69 | - | - | 86,5 | 88,8 | - | 74 | - | - | 70,5 | 65,5 | 70,0 |
| 70 | - | - | - | 88,5 | - | 78 | - | - | 68,0 | 65,5 | 68,0 |
| 74 | - | - | - | 83,0 | - | 80 | - | - | 66,5 | 65,5 | 67,1 |
| 78 | - | - | - | 77,5 | - | 82 | - | - | - | 65,5 | 66,3 |
| 82 | - | - | - | 73,0 | - | 86 | - | - | - | 65,0 | 63,1 |
| 84 | - | - | - | - | 64,5 | 90 | - | - | - | 63,5 | 58,5 |
| 86 | - | - | - | - | 62,5 | 92 | - | - | - | 61,5 | 56,1 |
| 90 | - | - | - | - | 59,0 | 93 | - | - | - | 60,5 | 55,0 |
| 93 | - | - | - | - | 57,0 | 94 | - | - | - | - | 53,5 |
| 94 | - | - | - | - | 57,0 | 98 | - | - | - | - | 53,5 |
| 98 | - | - | - | - | 52,3 | 102 | - | - | - | - | 50,5 |
| 102 | - | - | - | - | 48,1 | 105 | - | - | - | - | 49,4 |
| 106 | - | - | - | - | 44,3 | 106 | - | - | - | - | 48,2 |
| 110 | - | - | - | - | 40,3 | 110 | - | - | - | - | 46,3 |
| 114 | - | - | - | - | 35,1 | 114 | - | - | - | - | 42,6 |
| 116 | - | - | - | - | 29,6 | 118 | - | - | - | - | 41,7 |
| | | | | | 27,9 | 122 | - | - | - | - | 38,2 |
| | | | | | | 126 | - | - | - | - | 35,0 |
| | | | | | | 128 | - | - | - | - | 30,6 |
| | | | | | | | | | | | 26,1 |
| | | | | | | | | | | | 22,3 |
| | | | | | | | | | | | 20,9 |

* Main boom angle 85° · Hauptauslegerwinkel 85° · Jarret de flèche principale 85° · Inclinazione braccio base 85° · Ângulo de pluma principal 85° · Ângulo da lança principal 85° · Угол подъема гл. стрелы 85°

Main boom angle 87°, 85°, 75°, 65° and 55°, capacities for intermediate boom positions are calculated by the crane control system IC-1 · Hauptauslegerwinkel 87°, 85°, 75°, 65° und 55°, Traglasten für Zwischenstellungen des Hauptauslegers werden von der Kransteuerung IC-1 berechnet · Jarret de flèche principale 87°, 85°, 75°, 65° et 55°, le système de commande de la grue IC-1 calcule les charges pour les positions intermédiaires de la flèche · Inclinazione braccio base 87°, 85°, 75°, 65° e 55°, capacità per posizioni intermedie del braccio sono calcolate dal sistema di controllo della gru IC-1 · Ângulo de pluma principal 87°, 85°, 75°, 65° y 55°, las capacidades para posiciones de pluma intermedias son calculadas por el sistema de control de grúa IC-1 · Ângulos da lança principal 87°, 85°, 75°, 65° e 55°; as capacidades para posições da lança intermediária são calculadas pelo sistema de controle da grua IC-1 · Грузоподъемность при углах подъема главной стрелы 87°, 85°, 75°, 65° и 55°, грузоподъемность в промежуточных положениях стрелы рассчитывается системой управления краном IC-1

| 165 t + 50 t | | 11-19 m | | 8,40 m | | 9.8 m/s | | 360° | | ISO | |
|--------------|-------|-----------|------|--------|------|-------------|------|-----------|------|------|------|
| 78 m + 72 m | | | | | | 78 m + 84 m | | | | | |
| SWSL_1 | | | | | | SWSL_1 | | | | | |
| SFSL_1 | | | | | | SFSL_1 | | | | | |
| 0 t | | 0 t-325 t | | | | 0 t | | 0 t-325 t | | | |
| 87°/85° | | 87°/85° | | 75° | | 65° | | 55° | | 15° | |
| m | t | t | t | t | t | m | t | t | t | t | t |
| 24 | 63,0 | 64,5 | - | - | - | 27 | 47,6 | 48,8 | - | - | - |
| 26 | 62,5 | 64,0 | - | - | - | 28 | 47,5 | 48,6 | - | - | - |
| 28 | 61,5 | 63,5 | - | - | - | 30 | 47,2 | 48,2 | - | - | - |
| 30 | 57,0 | 64,0* | - | - | - | 34 | 45,6 | 48,1* | - | - | - |
| 34 | 50,0 | 63,0* | - | - | - | 38 | 39,9 | 47,6* | - | - | - |
| 35 | 48,5 | 62,7* | - | - | - | 39 | 38,7 | 47,4* | - | - | 47,0 |
| 38 | 44,2 | 62,0* | - | - | - | 42 | 35,1 | 46,8* | - | - | 46,8 |
| 42 | 39,2 | 60,5* | - | - | - | 46 | 31,0 | 45,9* | - | - | 46,5 |
| 46 | 34,9 | 59,0* | - | - | - | 50 | 27,5 | 45,0* | - | - | 46,0 |
| 50 | 31,2 | 57,5* | - | - | - | 54 | 24,4 | 44,0* | - | - | 45,4 |
| 54 | 28,0 | 55,5* | 57,0 | - | - | 58 | 21,7 | 42,8* | - | - | 44,6 |
| 58 | 25,2 | 54,0* | 57,0 | - | - | 60 | 20,5 | 42,2* | 41,5 | - | 44,3 |
| 62 | 22,7 | 52,0* | 57,0 | - | - | 62 | 19,3 | 41,7* | 41,5 | - | 43,9 |
| 66 | 20,5 | 50,0* | 57,0 | - | - | 66 | 17,2 | 40,6* | 41,5 | - | 43,0 |
| 70 | 18,6 | 48,7* | 56,5 | - | - | 70 | 15,2 | 39,4* | 41,5 | - | 42,0 |
| 74 | 16,9 | 47,1* | 56,0 | - | - | 74 | 13,5 | 38,2* | 41,5 | - | 41,1 |
| 76 | 16,1 | 46,3* | 55,5 | - | - | 78 | 12,0 | 37,1* | 41,5 | - | 40,1 |
| 78 | 13,1* | 45,6* | 55,0 | - | - | 82 | 10,5 | 36,0* | 41,5 | - | 39,1 |
| 79 | - | - | 54,6 | 47,9 | - | 86 | 9,3 | 35,0* | 41,4 | 33,8 | 38,1 |
| 82 | - | - | 53,5 | 47,9 | - | 87 | 9,0 | 34,7* | 41,2 | 33,8 | 37,9 |
| 86 | - | - | 52,5 | 47,9 | - | 90 | 6,2* | 33,9* | 40,7 | 33,8 | 37,2 |
| 90 | - | - | 50,5 | 47,9 | - | 94 | - | - | 40,0 | 33,8 | 36,1 |
| 92 | - | - | 50,0 | 47,8 | - | 98 | - | - | 39,1 | 33,8 | 35,1 |
| 94 | - | - | - | 47,8 | - | 102 | - | - | 38,2 | 33,7 | 34,2 |
| 98 | - | - | - | 47,8 | - | 103 | - | - | 38,0 | 33,7 | 33,7 |
| 100 | - | - | - | 47,6 | 40,3 | 106 | - | - | - | 33,7 | 33,0 |
| 102 | - | - | - | 47,5 | 40,0 | 109 | - | - | - | 33,7 | 27,8 |
| 105 | - | - | - | 47,4 | 40,0 | 110 | - | - | - | 33,7 | 27,7 |
| 106 | - | - | - | - | 40,0 | 114 | - | - | - | 33,7 | 27,7 |
| 110 | - | - | - | - | 40,0 | 116 | - | - | - | 33,7 | 27,7 |
| 114 | - | - | - | - | 38,4 | 118 | - | - | - | - | 27,7 |
| 117 | - | - | - | - | 37,0 | 122 | - | - | - | - | 27,5 |
| 118 | - | - | - | - | 32,2 | 126 | - | - | - | - | 27,5 |
| 122 | - | - | - | - | 29,3 | 128 | - | - | - | - | 27,5 |
| 126 | - | - | - | - | 26,2 | 130 | - | - | - | - | 24,1 |
| 130 | - | - | - | - | 22,2 | 134 | - | - | - | - | 21,3 |
| 134 | - | - | - | - | 18,1 | 138 | - | - | - | - | 18,1 |
| 138 | - | - | - | - | 15,7 | 142 | - | - | - | - | 14,6 |
| 139 | - | - | - | - | 14,8 | 146 | - | - | - | - | 11,4 |
| | | | | | | 150 | - | - | - | - | 9,1 |
| | | | | | | 151 | - | - | - | - | 8,2 |

* Main boom angle 85° · Hauptauslegerwinkel 85° · Jarret de flèche principale 85° · Inclinação braccio base 85° · Ángulo de pluma principal 85° · Ángulo da lança principal 85° · Угол подъема гл. стрелы 85°

Main boom angle 87°, 85°, 75°, 65° and 55°, capacities for intermediate boom positions are calculated by the crane control system IC-1 · Hauptauslegerwinkel 87°, 85°, 75°, 65° und 55°, Traglasten für Zwischenstellungen des Hauptauslegers werden von der Kransteuerung IC-1 berechnet · Jarret de flèche principale 87°, 85°, 75°, 65° et 55°, le système de commande de la grue IC-1 calcule les charges pour les positions intermédiaires de la flèche · Inclinação braccio base 87°, 85°, 75°, 65° e 55°, capacità per posizioni intermedie del braccio sono calcolate dal sistema di controllo della gru IC-1 · Ángulo de pluma principal 87°, 85°, 75°, 65° y 55°, las capacidades para posiciones de pluma intermedias son calculadas por el sistema de control de grúa IC-1 · Ângulos da lança principal 87°, 85°, 75°, 65° e 55°; as capacidades para posições da lança intermediária são calculadas pelo sistema de controle da grua IC-1 · Грузоподъемность при углах подъема главной стрелы 87°, 85°, 75°, 65° и 55°, грузоподъемность в промежуточных положениях стрелы рассчитывается системой управления краном IC-1

| 165 t + 50 t | | 11-19 m | | 8,40 m | | 9.8 m/s | | 360° | | ISO | |
|--------------|------|-----------|------|--------|------|-------------|---|--------|---|-----------|---|
| 78 m + 96 m | | SWSL_1 | | SFSL_1 | | 84 m + 24 m | | SWSL_1 | | SFSL_1 | |
| 0 t | | 0 t-325 t | | 0 t | | 0 t-325 t | | 0 t | | 0 t-325 t | |
| 87°/85° | | 87°/85° | | 75° | | 65° | | 55° | | 15° | |
| m | t | t | t | t | t | t | t | t | t | t | t |
| 30 | 35,0 | 36,0 | - | - | - | - | - | - | - | - | - |
| 34 | 34,6 | 35,4 | - | - | - | - | - | - | - | - | - |
| 38 | 34,0 | 35,1* | - | - | - | - | - | - | - | - | - |
| 42 | 31,3 | 34,8* | - | - | - | - | - | - | - | - | - |
| 43 | 30,3 | 34,6* | - | - | - | - | - | - | - | 34,4 | - |
| 46 | 27,4 | 34,2* | - | - | - | - | - | - | - | 34,1 | - |
| 50 | 23,9 | 33,7* | - | - | - | - | - | - | - | 33,8 | - |
| 54 | 21,0 | 33,0* | - | - | - | - | - | - | - | 33,5 | - |
| 58 | 18,4 | 32,4* | - | - | - | - | - | - | - | 32,8 | - |
| 62 | 16,0 | 31,6* | - | - | - | - | - | - | - | 32,1 | - |
| 65 | 14,5 | 31,0* | 29,1 | - | - | - | - | - | - | 31,6 | - |
| 66 | 14,0 | 30,9* | 29,1 | - | - | - | - | - | - | 31,5 | - |
| 70 | 12,1 | 30,1* | 29,1 | - | - | - | - | - | - | 30,7 | - |
| 74 | 10,4 | 29,4* | 29,1 | - | - | - | - | - | - | 30,0 | - |
| 78 | 8,9 | 28,6* | 29,1 | - | - | - | - | - | - | 29,2 | - |
| 82 | 7,5 | 27,8* | 29,1 | - | - | - | - | - | - | 28,4 | - |
| 86 | 6,2 | 27,0* | 29,1 | - | - | - | - | - | - | 27,6 | - |
| 90 | 5,0 | 26,3* | 29,1 | - | - | - | - | - | - | 26,8 | - |
| 92 | 4,4 | 25,9* | 29,1 | 22,5 | - | - | - | - | - | 26,5 | - |
| 93 | 4,2 | 25,7* | 29,1 | 22,5 | - | - | - | - | - | 26,3 | - |
| 94 | - | 25,6* | 29,1 | 22,5 | - | - | - | - | - | 26,1 | - |
| 98 | - | 24,9* | 28,9 | 22,5 | - | - | - | - | - | 25,3 | - |
| 99 | - | 24,7* | 28,8 | 22,5 | - | - | - | - | - | 25,1 | - |
| 102 | - | 24,3* | 28,7 | 22,5 | - | - | - | - | - | 24,5 | - |
| 106 | - | - | 28,5 | 22,5 | - | - | - | - | - | 23,8 | - |
| 110 | - | - | 28,1 | 22,5 | - | - | - | - | - | 23,0 | - |
| 114 | - | - | 27,8 | 22,5 | - | - | - | - | - | 22,3 | - |
| 115 | - | - | 27,7 | 22,5 | - | - | - | - | - | 22,0 | - |
| 117 | - | - | - | 22,5 | 17,6 | - | - | - | - | 21,7 | - |
| 118 | - | - | - | 22,5 | 17,6 | 21,5 | - | - | - | 21,5 | - |
| 122 | - | - | - | 22,5 | 17,6 | 20,8 | - | - | - | 20,8 | - |
| 126 | - | - | - | 22,5 | 17,6 | 20,1 | - | - | - | 20,1 | - |
| 128 | - | - | - | 22,5 | 17,6 | 19,8 | - | - | - | 19,8 | - |
| 130 | - | - | - | - | 17,6 | 19,2 | - | - | - | 19,2 | - |
| 134 | - | - | - | - | 17,6 | 18,5 | - | - | - | 18,5 | - |
| 138 | - | - | - | - | 17,6 | 17,8 | - | - | - | 17,8 | - |
| 140 | - | - | - | - | 17,6 | 16,9 | - | - | - | 16,9 | - |
| 142 | - | - | - | - | - | 16,0 | - | - | - | 16,0 | - |
| 146 | - | - | - | - | - | 13,6 | - | - | - | 13,6 | - |
| 150 | - | - | - | - | - | 10,6 | - | - | - | 10,6 | - |
| 154 | - | - | - | - | - | 7,6 | - | - | - | 7,6 | - |
| 158 | - | - | - | - | - | 5,6 | - | - | - | 5,6 | - |
| 160 | - | - | - | - | - | 4,4 | - | - | - | 4,4 | - |

0 t 65 t 125 t 165 t 205 t 245 t 285 t 325 t

* Main boom angle 85° · Hauptauslegerwinkel 85° · Jarret de flèche principale 85° · Inclinazione braccio base 85° · Ángulo de pluma principal 85° · Ángulo da lança principal 85° · Угол подъема гл. стрелы 85°

Main boom angle 87°, 85°, 75°, 65° and 55°, capacities for intermediate boom positions are calculated by the crane control system IC-1 · Hauptauslegerwinkel 87°, 85°, 75°, 65° und 55°, Traglasten für Zwischenstellungen des Hauptauslegers werden von der Kransteuerung IC-1 berechnet · Jarret de flèche principale 87°, 85°, 75°, 65° et 55°, le système de commande de la grue IC-1 calcule les charges pour les positions intermédiaires de la flèche · Inclinazione braccio base 87°, 85°, 75°, 65° e 55°, capacità per posizioni intermedie del braccio sono calcolate dal sistema di controllo della gru IC-1 · Ángulo de pluma principal 87°, 85°, 75°, 65° y 55°, las capacidades para posiciones de pluma intermedias son calculadas por el sistema de control de grúa IC-1 · Ângulos da lança principal 87°, 85°, 75°, 65° e 55°; as capacidades para posições da lança intermediária são calculadas pelo sistema de controle da grua IC-1 · Грузоподъемность при углах подъема главной стрелы 87°, 85°, 75°, 65° и 55°, грузоподъемность в промежуточных положениях стрелы рассчитывается системой управления краном IC-1

| 165 t + 50 t | | 11-19 m | | 8,40 m | | 9.8 m/s | | 360° | | ISO | |
|--------------|-------|-----------|-------|--------|------|-------------|-------|-----------|------|------|------|
| 84 m + 36 m | | | | | | 84 m + 48 m | | | | | |
| SWSL_1 | | | | | | SWSL_1 | | | | | |
| SFSL_1 | | | | | | SFSL_1 | | | | | |
| 0 t | | 0 t-325 t | | | | 0 t | | 0 t-325 t | | | |
| 87°/85° | | 87°/85° | | 75° | | 65° | | 55° | | 15° | |
| m | t | t | t | t | t | m | t | t | t | t | t |
| 16 | 123,0 | 133,0 | - | - | - | 19 | 98,0 | 101,0 | - | - | - |
| 18 | 111,0 | 130,0 | - | - | - | 20 | 94,0 | 100,0 | - | - | - |
| 20 | 102,0 | 128,0 | - | - | - | 22 | 86,5 | 99,0 | - | - | - |
| 22 | 93,5 | 132,0* | - | - | - | 24 | 80,0 | 101,0* | - | - | - |
| 23 | 90,0 | 130,5* | - | - | - | 26 | 74,0 | 100,0* | - | - | - |
| 24 | 86,5 | 129,0* | - | - | - | 28 | 69,0 | 98,5* | - | - | 98,0 |
| 26 | 80,5 | 126,0* | - | - | - | 30 | 64,5 | 97,0* | - | - | 98,0 |
| 28 | 75,0 | 123,0* | - | - | - | 34 | 57,0 | 93,0* | - | - | 97,6 |
| 30 | 70,5 | 120,0* | - | - | - | 38 | 50,5 | 89,0* | - | - | 96,8 |
| 34 | 62,0 | 113,0* | - | - | - | 42 | 45,4 | 85,0* | - | - | 95,5 |
| 38 | 55,5 | 107,0* | - | - | - | 46 | 41,0 | 81,0* | 93,5 | - | 94,1 |
| 41 | 51,5 | 102,5* | 123,0 | - | - | 50 | 37,3 | 77,5* | 92,5 | - | 92,5 |
| 42 | 46,4* | 101,0* | 123,0 | - | - | 53 | 34,9 | 74,8* | 91,0 | - | 91,0 |
| 44 | 44,2* | 99,0* | 121,3 | - | - | 54 | 30,8* | 74,0* | 90,5 | - | 90,5 |
| 46 | - | - | 120,0 | - | - | 56 | 29,5* | 72,5* | 89,0 | - | 89,5 |
| 50 | - | - | 115,0 | - | - | 58 | - | - | 87,5 | - | 88,5 |
| 54 | - | - | 109,0 | - | - | 62 | - | - | 84,0 | - | 86,0 |
| 58 | - | - | 102,0 | - | - | 66 | - | - | 81,0 | - | 83,5 |
| 59 | - | - | 101,0 | - | - | 68 | - | - | 79,0 | 80,0 | 81,6 |
| 61 | - | - | - | 104,0 | - | 70 | - | - | 77,0 | 79,5 | 80,3 |
| 62 | - | - | - | 103,0 | - | 74 | - | - | - | 79,0 | 76,8 |
| 66 | - | - | - | 96,0 | - | 78 | - | - | - | 76,0 | 72,5 |
| 70 | - | - | - | 89,5 | - | 82 | - | - | - | 71,5 | 66,5 |
| 72 | - | - | - | 86,5 | - | 84 | - | - | - | 69,5 | 63,5 |
| 74 | - | - | - | - | - | 86 | - | - | - | - | 61,2 |
| 78 | - | - | - | - | - | 87 | - | - | - | - | 59,9 |
| 79 | - | - | - | - | 70,0 | 70,0 | - | - | - | 56,5 | 56,0 |
| 82 | - | - | - | - | 67,0 | 65,8 | - | - | - | 53,5 | 51,4 |
| 85 | - | - | - | - | 64,0 | 61,6 | - | - | - | 51,5 | 48,0 |
| 86 | - | - | - | - | - | 60,3 | - | - | - | - | 47,0 |
| 90 | - | - | - | - | - | 55,0 | 102 | - | - | - | 42,9 |
| 94 | - | - | - | - | - | 50,6 | 106 | - | - | - | 39,3 |
| 98 | - | - | - | - | - | 46,3 | 110 | - | - | - | 35,4 |
| 102 | - | - | - | - | - | 42,1 | 114 | - | - | - | 31,2 |
| 106 | - | - | - | - | - | 36,0 | 118 | - | - | - | 26,1 |
| 110 | - | - | - | - | - | 30,5 | 121 | - | - | - | 23,1 |

0 t 65 t 125 t 165 t 205 t 245 t 285 t 325 t

* Main boom angle 85° · Hauptauslegerwinkel 85° · Jarret de flèche principale 85° · Inclinazione braccio base 85° · Ángulo de pluma principal 85° · Ángulo da lança principal 85° · Угол подъема гл. стрелы 85°

Main boom angle 87°, 85°, 75°, 65° and 55°, capacities for intermediate boom positions are calculated by the crane control system IC-1 · Hauptauslegerwinkel 87°, 85°, 75°, 65° und 55°, Traglasten für Zwischenstellungen des Hauptauslegers werden von der Kransteuerung IC-1 berechnet · Jarret de flèche principale 87°, 85°, 75°, 65° et 55°, le système de commande de la grue IC-1 calcule les charges pour les positions intermédiaires de la flèche · Inclinazione braccio base 87°, 85°, 75°, 65° e 55°, capacità per posizioni intermedie del braccio sono calcolate dal sistema di controllo della gru IC-1 · Ángulo de pluma principal 87°, 85°, 75°, 65° y 55°, las capacidades para posiciones de pluma intermedias son calculadas por el sistema de control de grúa IC-1 · Ángulos da lança principal 87°, 85°, 75°, 65° e 55°; as capacidades para posições da lança intermediária são calculadas pelo sistema de controle da grua IC-1 · Грузоподъемность при углах подъема главной стрелы 87°, 85°, 75°, 65° и 55°, грузоподъемность в промежуточных положениях стрелы рассчитывается системой управления краном IC-1

| 165 t + 50 t | | | | | | | | 11-19 m | | 8,40 m | | 9.8 m/s | | 360° | | ISO | | | |
|--------------|-------|-------|------|------|------|---|------|-----------|-------|--------|------|---------|------|------|---|------|---|--|--|
| 84 m + 60 m | | | | | | | | | | | | | | | | | | | |
| SWSL_1 | | | | | | | | SFSL_1 | | | | | | | | | | | |
| 0 t | | | | | | | | 0 t-325 t | | | | | | | | | | | |
| 87°/85° | | | | | | | | 87°/85° | | 75° | | 65° | | 55° | | 15° | | | |
| m | t | t | t | t | t | t | t | m | t | t | t | t | t | t | t | t | t | | |
| 22 | 76,5 | 78,0 | - | - | - | - | - | 24 | 58,0 | 59,5 | - | - | - | - | - | - | - | | |
| 24 | 74,0 | 77,0 | - | - | - | - | - | 26 | 57,5 | 59,0 | - | - | - | - | - | - | - | | |
| 26 | 68,5 | 76,0 | - | - | - | - | - | 28 | 57,0 | 58,0 | - | - | - | - | - | - | - | | |
| 28 | 64,0 | 77,5* | - | - | - | - | - | 30 | 54,5 | 59,0* | - | - | - | - | - | - | - | | |
| 30 | 59,5 | 77,0* | - | - | - | - | - | 34 | 47,9 | 58,0* | - | - | - | - | - | - | - | | |
| 32 | 55,7 | 76,0* | - | - | - | - | 75,5 | 36 | 45,0 | 57,2* | - | - | - | - | - | 57,0 | - | | |
| 34 | 52,0 | 75,0* | - | - | - | - | 75,2 | 38 | 42,2 | 56,5* | - | - | - | - | - | 56,8 | - | | |
| 38 | 46,4 | 72,5* | - | - | - | - | 74,8 | 42 | 37,4 | 55,5* | - | - | - | - | - | 56,5 | - | | |
| 42 | 41,4 | 70,0* | - | - | - | - | 74,5 | 46 | 33,3 | 54,0* | - | - | - | - | - | 55,8 | - | | |
| 46 | 37,1 | 67,5* | - | - | - | - | 73,5 | 50 | 29,8 | 52,0* | - | - | - | - | - | 55,1 | - | | |
| 50 | 33,4 | 65,0* | - | - | - | - | 72,5 | 54 | 26,7 | 50,5* | - | - | - | - | - | 54,5 | - | | |
| 51 | 32,6 | 64,2* | 69,5 | - | - | - | 72,2 | 56 | 25,3 | 49,7* | 52,0 | - | - | - | - | 54,0 | - | | |
| 54 | 30,2 | 62,0* | 69,5 | - | - | - | 71,5 | 58 | 24,0 | 48,9* | 52,0 | - | - | - | - | 53,5 | - | | |
| 58 | 27,5 | 59,5* | 69,0 | - | - | - | 70,1 | 62 | 21,6 | 47,1* | 52,0 | - | - | - | - | 52,7 | - | | |
| 62 | 25,1 | 57,5* | 68,0 | - | - | - | 68,6 | 66 | 19,5 | 45,4* | 51,5 | - | - | - | - | 51,5 | - | | |
| 64 | 24,0 | 56,5* | 67,0 | - | - | - | 67,8 | 70 | 17,6 | 43,8* | 51,5 | - | - | - | - | 50,4 | - | | |
| 66 | 20,2* | 55,5* | 66,0 | - | - | - | 67,0 | 74 | 15,9 | 42,2* | 50,5 | - | - | - | - | 49,2 | - | | |
| 67 | 19,7* | 55,0* | 65,5 | - | - | - | 66,5 | 76 | 15,2 | 41,5* | 50,0 | - | - | - | - | 48,5 | - | | |
| 70 | - | - | 64,0 | - | - | - | 65,3 | 78 | 12,0* | 40,8* | 49,5 | - | - | - | - | 47,9 | - | | |
| 74 | - | - | 61,5 | 59,0 | - | - | 63,1 | 79 | 11,6* | 40,4* | 49,1 | - | - | - | - | 47,6 | - | | |
| 78 | - | - | 59,0 | 59,0 | - | - | 61,5 | 81 | - | - | 48,4 | 43,1 | - | - | - | 46,9 | - | | |
| 82 | - | - | 56,5 | 59,0 | - | - | 59,3 | 82 | - | - | 48,1 | 43,1 | - | - | - | 46,6 | - | | |
| 86 | - | - | - | 57,5 | - | - | 57,5 | 86 | - | - | 46,7 | 43,1 | - | - | - | 45,3 | - | | |
| 90 | - | - | - | 56,0 | - | - | 55,5 | 90 | - | - | 45,0 | 43,1 | - | - | - | 44,0 | - | | |
| 94 | - | - | - | 54,0 | - | - | 51,7 | 93 | - | - | 43,7 | 43,1 | - | - | - | 42,9 | - | | |
| 95 | - | - | - | 53,2 | 48,7 | - | 50,7 | 94 | - | - | - | 43,1 | - | - | - | 42,5 | - | | |
| 96 | - | - | - | 52,5 | 48,7 | - | 49,8 | 98 | - | - | - | 42,9 | - | - | - | 40,8 | - | | |
| 98 | - | - | - | - | 47,9 | - | 47,7 | 102 | - | - | - | 42,3 | - | - | - | 39,4 | - | | |
| 102 | - | - | - | - | 45,3 | - | 43,6 | 104 | - | - | - | 41,7 | 35,6 | - | - | 38,6 | - | | |
| 106 | - | - | - | - | 42,9 | - | 39,9 | 106 | - | - | - | 41,1 | 35,3 | - | - | 37,8 | - | | |
| 108 | - | - | - | - | 41,8 | - | 38,1 | 107 | - | - | - | 40,7 | 35,3 | - | - | 37,4 | - | | |
| 110 | - | - | - | - | - | - | 36,4 | 110 | - | - | - | - | 35,3 | - | - | 35,8 | - | | |
| 114 | - | - | - | - | - | - | 33,2 | 114 | - | - | - | - | 35,3 | - | - | 33,4 | - | | |
| 118 | - | - | - | - | - | - | 30,2 | 118 | - | - | - | - | 34,0 | - | - | 30,4 | - | | |
| 122 | - | - | - | - | - | - | 26,6 | 120 | - | - | - | - | 33,1 | - | - | 29,0 | - | | |
| 126 | - | - | - | - | - | - | 22,4 | 122 | - | - | - | - | - | - | - | 27,6 | - | | |
| 130 | - | - | - | - | - | - | 18,1 | 126 | - | - | - | - | - | - | - | 24,9 | - | | |
| 133 | - | - | - | - | - | - | 16,5 | 130 | - | - | - | - | - | - | - | 21,8 | - | | |
| | | | | | | | | 134 | - | - | - | - | - | - | - | 18,4 | - | | |
| | | | | | | | | 138 | - | - | - | - | - | - | - | 14,8 | - | | |
| | | | | | | | | 142 | - | - | - | - | - | - | - | 11,8 | - | | |
| | | | | | | | | 145 | - | - | - | - | - | - | - | 9,8 | - | | |

0t 65t 125t 165t 205t 245t 285t 325t

* Main boom angle 85° · Hauptauslegerwinkel 85° · Jarret de flèche principale 85° · Inclinazione braccio base 85° · Ángulo de pluma principal 85° · Ângulo da lança principal 85° · Угол подъема гл. стрелы 85°

Main boom angle 87°, 85°, 75°, 65° and 55°, capacities for intermediate boom positions are calculated by the crane control system IC-1 · Hauptauslegerwinkel 87°, 85°, 75°, 65° und 55°, Traglasten für Zwischenstellungen des Hauptauslegers werden von der Kransteuerung IC-1 berechnet · Jarret de flèche principale 87°, 85°, 75°, 65° et 55°, le système de commande de la grue IC-1 calcule les charges pour les positions intermédiaires de la flèche · Inclinazione braccio base 87°, 85°, 75°, 65° e 55°, capacità per posizioni intermedie del braccio sono calcolate dal sistema di controllo della gru IC-1 · Ángulo de pluma principal 87°, 85°, 75°, 65° y 55°, las capacidades para posiciones de pluma intermedias son calculadas por el sistema de control de grúa IC-1 · Ângulos da lança principal 87°, 85°, 75°, 65° e 55°; as capacidades para posições da lança intermediária são calculadas pelo sistema de controle da grua IC-1 · Грузоподъемность при углах подъема главной стрелы 87°, 85°, 75°, 65° и 55°, грузоподъемность в промежуточных положениях стрелы рассчитывается системой управления краном IC-1

| 165 t + 50 t | | 11-19 m | | 8,40 m | | 9.8 m/s | | 360° | | ISO | |
|--------------|------|-----------|------|--------|------|-------------|------|-----------|------|------|------|
| 84 m + 84 m | | | | | | 84 m + 96 m | | | | | |
| SWSL_1 | | | | | | SWSL_1 | | | | | |
| SFSL_1 | | | | | | SFSL_1 | | | | | |
| 0 t | | 0 t-325 t | | | | 0 t | | 0 t-325 t | | | |
| 87°/85° | | 87°/85° | | 75° | | 65° | | 55° | | 15° | |
| m | t | t | t | t | t | m | t | t | t | t | t |
| 27 | 43,7 | 45,0 | - | - | - | 30 | 32,0 | 33,0 | - | - | - |
| 28 | 43,6 | 44,8 | - | - | - | 34 | 31,6 | 32,5 | - | - | - |
| 30 | 43,3 | 44,4 | - | - | - | 38 | 31,2 | 32,2* | - | - | - |
| 34 | 42,3 | 44,2* | - | - | - | 42 | 29,9 | 31,8* | - | - | - |
| 38 | 38,0 | 43,6* | - | - | - | 44 | 27,9 | 31,5* | - | - | 31,3 |
| 40 | 35,7 | 43,2* | - | - | - | 46 | 26,0 | 31,2* | - | - | 31,1 |
| 42 | 33,4 | 42,8* | - | - | - | 50 | 22,8 | 30,7* | - | - | 30,8 |
| 46 | 29,5 | 42,0* | - | - | - | 54 | 19,8 | 30,0* | - | - | 30,5 |
| 50 | 26,0 | 41,0* | - | - | - | 58 | 17,3 | 29,3* | - | - | 29,9 |
| 54 | 23,1 | 40,0* | - | - | - | 62 | 15,0 | 28,6* | - | - | 29,3 |
| 58 | 20,5 | 38,8* | - | - | - | 66 | 13,0 | 27,8* | 26,3 | - | 28,7 |
| 61 | 18,7 | 37,9* | 37,8 | - | - | 70 | 11,2 | 27,1* | 26,3 | - | 28,0 |
| 62 | 18,1 | 37,7* | 37,8 | - | - | 74 | 9,6 | 26,3* | 26,3 | - | 27,3 |
| 66 | 16,1 | 36,6* | 37,8 | - | - | 78 | 8,0 | 25,5* | 26,3 | - | 26,6 |
| 70 | 14,2 | 35,4* | 37,8 | - | - | 82 | 6,7 | 24,7* | 26,3 | - | 25,9 |
| 74 | 12,5 | 34,2* | 37,8 | - | - | 86 | 5,5 | 23,9* | 26,3 | - | 25,1 |
| 78 | 11,0 | 33,1* | 37,7 | - | - | 90 | 4,3 | 23,1* | 26,2 | - | 24,4 |
| 82 | 9,7 | 32,0* | 37,3 | - | - | 91 | 4,0 | 22,9* | 26,2 | - | 24,2 |
| 86 | 8,4 | 31,0* | 36,9 | - | - | 94 | - | 22,4* | 26,2 | - | 23,7 |
| 88 | 7,9 | 30,5* | 36,5 | 30,3 | - | 95 | - | 22,2* | 26,2 | 20,0 | 23,5 |
| 90 | 5,2* | 30,0* | 36,2 | 30,3 | - | 98 | - | 21,7* | 25,9 | 20,0 | 22,9 |
| 91 | 4,9* | 29,7* | 36,0 | 30,3 | - | 99 | - | 21,5* | 25,7 | 20,0 | 22,8 |
| 94 | - | - | 35,4 | 30,3 | - | 102 | - | 21,0* | 25,4 | 20,0 | 22,2 |
| 98 | - | - | 34,5 | 30,3 | - | 106 | - | - | 24,9 | 20,0 | 21,5 |
| 102 | - | - | 33,5 | 30,3 | - | 110 | - | - | 24,4 | 20,0 | 20,7 |
| 105 | - | - | 32,7 | 30,3 | - | 114 | - | - | 23,8 | 20,0 | 20,0 |
| 106 | - | - | - | 30,3 | - | 117 | - | - | 23,4 | 20,0 | 19,4 |
| 110 | - | - | - | 30,3 | - | 118 | - | - | - | 20,0 | 19,2 |
| 112 | - | - | - | 30,3 | 24,3 | 121 | - | - | - | 20,0 | 15,2 |
| 114 | - | - | - | 30,3 | 24,3 | 122 | - | - | - | 20,0 | 15,2 |
| 118 | - | - | - | 30,0 | 24,3 | 126 | - | - | - | 20,0 | 15,2 |
| 119 | - | - | - | 30,0 | 24,3 | 130 | - | - | - | 20,0 | 15,2 |
| 122 | - | - | - | - | 24,3 | 134 | - | - | - | - | 15,1 |
| 126 | - | - | - | - | 24,1 | 138 | - | - | - | - | 15,1 |
| 130 | - | - | - | - | 24,1 | 142 | - | - | - | - | 15,1 |
| 132 | - | - | - | - | 24,1 | 143 | - | - | - | - | 15,1 |
| 134 | - | - | - | - | 20,0 | 146 | - | - | - | - | 13,2 |
| 138 | - | - | - | - | 17,7 | 150 | - | - | - | - | 11,1 |
| 142 | - | - | - | - | 14,5 | 154 | - | - | - | - | 8,3 |
| 146 | - | - | - | - | 11,3 | 158 | - | - | - | - | 5,4 |
| 150 | - | - | - | - | 8,2 | 161 | - | - | - | - | 4,1 |
| 154 | - | - | - | - | 5,8 | | | | | | |
| 156 | - | - | - | - | 4,6 | | | | | | |

0 t 65 t 125 t 165 t 205 t 245 t 285 t 325 t

* Main boom angle 85° · Hauptauslegerwinkel 85° · Jarret de flèche principale 85° · Inclinazione braccio base 85° · Ángulo de pluma principal 85° · Ángulo da lança principal 85° · Угол подъема гл. стрелы 85°

Main boom angle 87°, 85°, 75°, 65° and 55°, capacities for intermediate boom positions are calculated by the crane control system IC-1 · Hauptauslegerwinkel 87°, 85°, 75°, 65° und 55°, Traglasten für Zwischenstellungen des Hauptauslegers werden von der Kransteuerung IC-1 berechnet · Jarret de flèche principale 87°, 85°, 75°, 65° et 55°, le système de commande de la grue IC-1 calcule les charges pour les positions intermédiaires de la flèche · Inclinazione braccio base 87°, 85°, 75°, 65° e 55°, capacità per posizioni intermedie del braccio sono calcolate dal sistema di controllo della gru IC-1 · Ángulo de pluma principal 87°, 85°, 75°, 65° y 55°, las capacidades para posiciones de pluma intermedias son calculadas por el sistema de control de grúa IC-1 · Ángulos da lança principal 87°, 85°, 75°, 65° e 55°; as capacidades para posições da lança intermediária são calculadas pelo sistema de controle da grua IC-1 · Грузоподъемность при углах подъема главной стрелы 87°, 85°, 75°, 65° и 55°, грузоподъемность в промежуточных положениях стрелы рассчитывается системой управления краном IC-1

| 165 t + 50 t | | 11-19 m | | 8,40 m | | 9.8 m/s | | 360° | | ISO | |
|--------------|-------|---------|-------|--------|------|-------------|---|------|---|-------|---|
| 90 m + 24 m | | | | | | 90 m + 36 m | | | | | |
| SWSL_1 | | | | | | SWSL_1 | | | | | |
| 0 t | | | | | | 0 t-325 t | | | | | |
| 87°/85° | | 87°/85° | | 75° | | 65° | | 55° | | 15° | |
| m | t | t | t | t | t | t | t | t | t | t | t |
| 14 | 141,0 | 157,0 | - | - | - | - | - | - | - | - | - |
| 16 | 127,0 | 153,0 | - | - | - | - | - | - | - | - | - |
| 18 | 115,0 | 158,0* | - | - | - | - | - | - | - | - | - |
| 20 | 105,0 | 154,0* | - | - | - | - | - | - | - | 153,0 | - |
| 22 | 97,5 | 150,0* | - | - | - | - | - | - | - | 152,0 | - |
| 24 | 90,0 | 145,0* | - | - | - | - | - | - | - | 152,0 | - |
| 26 | 84,0 | 141,0* | - | - | - | - | - | - | - | 151,0 | - |
| 28 | 78,5 | 136,0* | - | - | - | - | - | - | - | 150,0 | - |
| 30 | 74,0 | 131,0* | - | - | - | - | - | - | - | 149,0 | - |
| 33 | 62,0* | 126,0* | - | - | - | - | - | - | - | 147,0 | - |
| 34 | - | - | - | - | - | - | - | - | - | 146,3 | - |
| 38 | - | - | 144,0 | - | - | - | - | - | - | 143,0 | - |
| 42 | - | - | 137,0 | - | - | - | - | - | - | 139,0 | - |
| 46 | - | - | 129,0 | - | - | - | - | - | - | 135,0 | - |
| 49 | - | - | 122,0 | - | - | - | - | - | - | 130,5 | - |
| 50 | - | - | - | - | - | - | - | - | - | 129,0 | - |
| 54 | - | - | - | - | - | - | - | - | - | 123,0 | - |
| 57 | - | - | - | 114,0 | - | - | - | - | - | 114,0 | - |
| 58 | - | - | - | 111,0 | - | - | - | - | - | 111,0 | - |
| 62 | - | - | - | 103,0 | - | - | - | - | - | 100,1 | - |
| 63 | - | - | - | 101,0 | - | - | - | - | - | 97,7 | - |
| 66 | - | - | - | - | - | - | - | - | - | 90,5 | - |
| 70 | - | - | - | - | - | - | - | - | - | 82,5 | - |
| 74 | - | - | - | - | 75,5 | - | - | - | - | 75,1 | - |
| 77 | - | - | - | - | 72,0 | - | - | - | - | 70,1 | - |
| 78 | - | - | - | - | - | - | - | - | - | 68,5 | - |
| 82 | - | - | - | - | - | - | - | - | - | 62,8 | - |
| 86 | - | - | - | - | - | - | - | - | - | 57,3 | - |
| 90 | - | - | - | - | - | - | - | - | - | 52,0 | - |
| 94 | - | - | - | - | - | - | - | - | - | 47,7 | - |
| 98 | - | - | - | - | - | - | - | - | - | 42,3 | - |
| 102 | - | - | - | - | - | - | - | - | - | 35,7 | - |
| 103 | - | - | - | - | - | - | - | - | - | 34,1 | - |
| 17 | 112,0 | 120,0 | - | - | - | - | - | - | - | - | - |
| 18 | 107,0 | 118,0 | - | - | - | - | - | - | - | - | - |
| 20 | 97,5 | 116,0 | - | - | - | - | - | - | - | - | - |
| 22 | 90,0 | 119,0* | - | - | - | - | - | - | - | - | - |
| 24 | 83,0 | 117,0* | - | - | - | - | - | - | - | 116,0 | - |
| 26 | 77,5 | 114,0* | - | - | - | - | - | - | - | 115,0 | - |
| 28 | 72,0 | 112,0* | - | - | - | - | - | - | - | 115,0 | - |
| 30 | 67,5 | 109,0* | - | - | - | - | - | - | - | 115,0 | - |
| 34 | 60,0 | 103,0* | - | - | - | - | - | - | - | 113,6 | - |
| 38 | 53,5 | 97,0* | - | - | - | - | - | - | - | 112,0 | - |
| 42 | 48,7 | 92,0* | - | - | - | - | - | - | - | 110,0 | - |
| 43 | 43,2* | 91,1* | 109,0 | - | - | - | - | - | - | 109,3 | - |
| 45 | 41,2* | 89,5* | 107,0 | - | - | - | - | - | - | 108,0 | - |
| 46 | - | - | 106,0 | - | - | - | - | - | - | 107,3 | - |
| 50 | - | - | 102,0 | - | - | - | - | - | - | 104,6 | - |
| 54 | - | - | 97,5 | - | - | - | - | - | - | 102,0 | - |
| 58 | - | - | 92,0 | - | - | - | - | - | - | 98,3 | - |
| 60 | - | - | 89,0 | - | - | - | - | - | - | 96,5 | - |
| 62 | - | - | - | - | - | - | - | - | - | 94,6 | - |
| 63 | - | - | - | - | - | 92,0 | - | - | - | 93,7 | - |
| 66 | - | - | - | - | - | 90,5 | - | - | - | 91,0 | - |
| 70 | - | - | - | - | - | 86,0 | - | - | - | 83,6 | - |
| 74 | - | - | - | - | - | 81,0 | - | - | - | 76,6 | - |
| 75 | - | - | - | - | - | 80,0 | - | - | - | 75,0 | - |
| 78 | - | - | - | - | - | - | - | - | - | 70,0 | - |
| 82 | - | - | - | - | - | - | - | 64,0 | - | 64,1 | - |
| 86 | - | - | - | - | - | - | - | 60,5 | - | 58,8 | - |
| 89 | - | - | - | - | - | - | - | 58,0 | - | 54,8 | - |
| 90 | - | - | - | - | - | - | - | - | - | 53,5 | - |
| 94 | - | - | - | - | - | - | - | - | - | 48,9 | - |
| 98 | - | - | - | - | - | - | - | - | - | 44,6 | - |
| 102 | - | - | - | - | - | - | - | - | - | 40,6 | - |
| 106 | - | - | - | - | - | - | - | - | - | 36,4 | - |
| 110 | - | - | - | - | - | - | - | - | - | 31,6 | - |
| 114 | - | - | - | - | - | - | - | - | - | 26,1 | - |
| 115 | - | - | - | - | - | - | - | - | - | 25,1 | - |

* Main boom angle 85° · Hauptauslegerwinkel 85° · Jarret de flèche principale 85° · Inclinazione braccio base 85° · Ângulo de pluma principal 85° · Ângulo da lança principal 85° · Угол подъема гл. стрелы 85°

Main boom angle 87°, 85°, 75°, 65° and 55°, capacities for intermediate boom positions are calculated by the crane control system IC-1 · Hauptauslegerwinkel 87°, 85°, 75°, 65° und 55°, Traglasten für Zwischenstellungen des Hauptauslegers werden von der Kransteuerung IC-1 berechnet · Jarret de flèche principale 87°, 85°, 75°, 65° et 55°, le système de commande de la grue IC-1 calcule les charges pour les positions intermédiaires de la flèche · Inclinazione braccio base 87°, 85°, 75°, 65° e 55°, capacità per posizioni intermedie del braccio sono calcolate dal sistema di controllo della gru IC-1 · Ângulo de pluma principal 87°, 85°, 75°, 65° y 55°, las capacidades para posiciones de pluma intermedias son calculadas por el sistema de control de grúa IC-1 · Ângulos da lança principal 87°, 85°, 75°, 65° e 55°; as capacidades para posições da lança intermediária são calculadas pelo sistema de controle da grua IC-1 · Грузоподъемность при углах подъема главной стрелы 87°, 85°, 75°, 65° и 55°, грузоподъемность в промежуточных положениях стрелы рассчитывается системой управления краном IC-1

| 165 t + 50 t | | 11-19 m | | 8,40 m | | 9.8 m/s | | 360° | | ISO | |
|--------------|-------|---------|------|--------|------|-------------|-------|-------|------|------|------|
| 90 m + 48 m | | | | | | 90 m + 60 m | | | | | |
| SWSL_1 | | | | | | SWSL_1 | | | | | |
| 0 t | | | | | | 0 t-325 t | | | | | |
| 87°/85° | | | | | | 87°/85° | | | | | |
| 75° | | | | | | 75° | | | | | |
| 65° | | | | | | 65° | | | | | |
| 55° | | | | | | 55° | | | | | |
| 15° | | | | | | 15° | | | | | |
| m | t | t | t | t | t | m | t | t | t | t | t |
| 19 | 90,0 | 92,5 | - | - | - | 22 | 69,0 | 70,5 | - | - | - |
| 20 | 89,0 | 92,0 | - | - | - | 24 | 68,0 | 69,5 | - | - | - |
| 22 | 83,0 | 90,5 | - | - | - | 26 | 65,5 | 69,0 | - | - | - |
| 24 | 76,5 | 92,5* | - | - | - | 28 | 61,0 | 70,0* | - | - | - |
| 26 | 71,0 | 91,0* | - | - | - | 30 | 57,0 | 69,0* | - | - | - |
| 28 | 66,5 | 90,0* | - | - | 88,5 | 32 | 53,5 | 68,0* | - | - | 67,5 |
| 30 | 62,0 | 88,0* | - | - | 88,5 | 34 | 50,0 | 67,0* | - | - | 67,2 |
| 34 | 54,5 | 84,5* | - | - | 88,1 | 38 | 44,4 | 65,0* | - | - | 66,8 |
| 38 | 48,7 | 81,0* | - | - | 87,3 | 42 | 39,6 | 62,5* | - | - | 66,5 |
| 42 | 43,6 | 77,0* | - | - | 86,0 | 46 | 35,5 | 60,0* | - | - | 65,5 |
| 46 | 39,4 | 73,5* | - | - | 84,6 | 50 | 32,0 | 58,0* | - | - | 64,5 |
| 47 | 38,5 | 72,6* | 83,5 | - | 84,3 | 53 | 29,6 | 56,1* | 62,5 | - | 63,7 |
| 50 | 35,8 | 70,0* | 83,0 | - | 83,0 | 54 | 28,9 | 55,5* | 62,5 | - | 63,5 |
| 53 | 33,5 | 67,7* | 81,5 | - | 81,5 | 58 | 26,2 | 53,0* | 62,0 | - | 61,9 |
| 54 | 29,1* | 67,0* | 81,0 | - | 81,0 | 62 | 23,9 | 51,0* | 60,5 | - | 60,3 |
| 56 | 27,9* | 66,0* | 79,7 | - | 80,0 | 65 | 22,4 | 49,5* | 59,5 | - | 59,3 |
| 58 | - | - | 78,5 | - | 79,0 | 66 | 18,8* | 49,0* | 59,0 | - | 59,0 |
| 62 | - | - | 75,5 | - | 76,8 | 68 | 17,9* | 48,2* | 58,0 | - | 58,0 |
| 66 | - | - | 72,5 | - | 74,5 | 70 | - | - | 57,0 | - | 57,0 |
| 70 | - | - | 69,0 | 68,5 | 72,1 | 74 | - | - | 55,0 | - | 55,1 |
| 72 | - | - | 67,5 | 68,0 | 71,0 | 77 | - | - | 53,5 | 52,0 | 53,9 |
| 74 | - | - | - | 67,5 | 69,1 | 78 | - | - | 53,0 | 52,0 | 53,5 |
| 78 | - | - | - | 65,5 | 66,5 | 82 | - | - | 50,5 | 52,0 | 51,5 |
| 82 | - | - | - | 62,5 | 64,1 | 83 | - | - | 49,8 | 51,6 | 51,0 |
| 86 | - | - | - | 59,5 | 59,8 | 86 | - | - | - | 50,5 | 49,7 |
| 87 | - | - | - | 58,5 | 58,5 | 90 | - | - | - | 49,3 | 48,2 |
| 90 | - | - | - | - | 54,5 | 94 | - | - | - | 47,2 | 45,9 |
| 91 | - | - | - | - | 53,3 | 98 | - | - | - | 44,8 | 43,8 |
| 94 | - | - | - | - | 51,0 | 99 | - | - | - | - | 41,6 |
| 98 | - | - | - | - | 48,3 | 102 | - | - | - | - | 41,5 |
| 100 | - | - | - | - | 47,0 | 106 | - | - | - | - | 40,4 |
| 102 | - | - | - | - | 41,6 | 110 | - | - | - | - | 38,4 |
| 106 | - | - | - | - | 37,9 | 112 | - | - | - | - | 37,4 |
| 110 | - | - | - | - | 34,4 | 114 | - | - | - | - | - |
| 114 | - | - | - | - | 31,2 | 118 | - | - | - | - | 28,8 |
| 118 | - | - | - | - | 27,2 | 122 | - | - | - | - | 25,9 |
| 122 | - | - | - | - | 22,6 | 126 | - | - | - | - | 22,9 |
| 126 | - | - | - | - | 18,5 | 130 | - | - | - | - | 19,0 |
| 127 | - | - | - | - | 17,9 | 134 | - | - | - | - | 14,9 |
| | | | | | | 138 | - | - | - | - | 12,4 |

* Main boom angle 85° · Hauptauslegerwinkel 85° · Jarret de flèche principale 85° · Inclinazione braccio base 85° · Ângulo de pluma principal 85° · Ângulo da lança principal 85° · Угол подъема гл. стрелы 85°

Main boom angle 87°, 85°, 75°, 65° and 55°, capacities for intermediate boom positions are calculated by the crane control system IC-1 · Hauptauslegerwinkel 87°, 85°, 75°, 65° und 55°, Traglasten für Zwischenstellungen des Hauptauslegers werden von der Kransteuerung IC-1 berechnet · Jarret de flèche principale 87°, 85°, 75°, 65° et 55°, le système de commande de la grue IC-1 calcule les charges pour les positions intermédiaires de la flèche · Inclinazione braccio base 87°, 85°, 75°, 65° e 55°, capacità per posizioni intermedie del braccio sono calcolate dal sistema di controllo della gru IC-1 · Ângulo de pluma principal 87°, 85°, 75°, 65° y 55°, las capacidades para posiciones de pluma intermedias son calculadas por el sistema de control de grúa IC-1 · Ângulos da lança principal 87°, 85°, 75°, 65° e 55°; as capacidades para posições da lança intermediária são calculadas pelo sistema de controle da grua IC-1 · Грузоподъемность при углах подъема главной стрелы 87°, 85°, 75°, 65° и 55°, грузоподъемность в промежуточных положениях стрелы рассчитывается системой управления краном IC-1

| 165 t + 50 t | | | | | | | | 11-19 m | | 8,40 m | | 9.8 m/s | | 360° | | ISO | | | |
|--------------|-------|-------|------|------|------|------|------|-----------|------|--------|------|---------|------|------|------|-----|---|--|--|
| 90 m + 72 m | | | | | | | | | | | | | | | | | | | |
| SWSL_1 | | | | | | | | SFSL_1 | | | | | | | | | | | |
| 0 t | | | | | | | | 0 t-325 t | | | | | | | | | | | |
| 87°/85° | | | | | | | | 87°/85° | | 75° | | 65° | | 55° | | 15° | | | |
| m | t | t | t | t | t | t | t | m | t | t | t | t | t | t | t | t | t | | |
| 25 | 52,5 | 54,0 | - | - | - | - | - | 27 | 39,9 | 41,2 | - | - | - | - | - | - | - | | |
| 26 | 52,5 | 54,0 | - | - | - | - | - | 28 | 39,8 | 41,0 | - | - | - | - | - | - | - | | |
| 28 | 52,0 | 53,0 | - | - | - | - | - | 30 | 39,5 | 40,5 | - | - | - | - | - | - | - | | |
| 30 | 51,0 | 53,5* | - | - | - | - | - | 34 | 38,9 | 40,4* | - | - | - | - | - | - | - | | |
| 34 | 45,8 | 53,0* | - | - | - | - | - | 38 | 36,1 | 39,8* | - | - | - | - | - | - | - | | |
| 36 | 43,0 | 52,2* | - | - | - | - | 51,5 | 40 | 33,8 | 39,4* | - | - | - | - | 38,9 | - | - | | |
| 38 | 40,3 | 51,5* | - | - | - | - | 51,5 | 42 | 31,6 | 39,0* | - | - | - | - | 38,8 | - | - | | |
| 42 | 35,6 | 50,0* | - | - | - | - | 51,5 | 46 | 27,9 | 38,1* | - | - | - | - | 38,4 | - | - | | |
| 46 | 31,7 | 48,9* | - | - | - | - | 50,8 | 50 | 24,6 | 37,1* | - | - | - | - | 38,0 | - | - | | |
| 50 | 28,3 | 47,3* | - | - | - | - | 50,1 | 54 | 21,7 | 36,1* | - | - | - | - | 37,6 | - | - | | |
| 54 | 25,3 | 45,7* | - | - | - | - | 49,4 | 58 | 19,2 | 35,0* | - | - | - | - | 36,9 | - | - | | |
| 58 | 22,7 | 44,0* | 46,9 | - | - | - | 48,6 | 62 | 17,0 | 33,8* | - | - | - | - | 36,2 | - | - | | |
| 62 | 20,4 | 42,3* | 46,9 | - | - | - | 47,5 | 63 | 16,5 | 33,5* | 34,1 | - | - | - | 36,0 | - | - | | |
| 66 | 18,4 | 40,7* | 46,8 | - | - | - | 46,5 | 66 | 15,0 | 32,7* | 34,1 | - | - | - | 35,5 | - | - | | |
| 70 | 16,5 | 39,2* | 46,1 | - | - | - | 45,3 | 70 | 13,2 | 31,6* | 34,1 | - | - | - | 34,6 | - | - | | |
| 74 | 14,9 | 37,7* | 45,0 | - | - | - | 44,1 | 74 | 11,6 | 30,4* | 34,1 | - | - | - | 33,7 | - | - | | |
| 76 | 14,2 | 37,0* | 44,5 | - | - | - | 43,5 | 78 | 10,1 | 29,3* | 33,9 | - | - | - | 32,9 | - | - | | |
| 78 | 10,8* | 36,4* | 44,0 | - | - | - | 42,9 | 82 | 8,8 | 28,3* | 33,3 | - | - | - | 31,9 | - | - | | |
| 79 | 10,5* | 36,1* | 43,6 | - | - | - | 42,6 | 86 | 7,6 | 27,3* | 32,7 | - | - | - | 31,0 | - | - | | |
| 82 | - | - | 42,7 | - | - | - | 41,6 | 88 | 7,1 | 26,8* | 32,3 | - | - | - | 30,5 | - | - | | |
| 84 | - | - | 41,9 | 38,3 | - | - | 41,0 | 90 | 4,1* | 26,4* | 31,9 | - | - | - | 30,0 | - | - | | |
| 86 | - | - | 41,2 | 38,3 | - | - | 40,3 | 91 | - | 26,1* | 31,6 | 26,8 | - | - | 29,7 | - | - | | |
| 90 | - | - | 39,7 | 38,3 | - | - | 39,0 | 94 | - | - | 31,0 | 26,8 | - | - | 29,0 | - | - | | |
| 94 | - | - | 38,1 | 38,3 | - | - | 37,6 | 98 | - | - | 30,1 | 26,8 | - | - | 28,1 | - | - | | |
| 95 | - | - | 37,6 | 38,1 | - | - | 37,3 | 102 | - | - | 29,1 | 26,8 | - | - | 27,1 | - | - | | |
| 98 | - | - | - | 37,6 | - | - | 36,2 | 106 | - | - | 28,0 | 26,8 | - | - | 26,1 | - | - | | |
| 102 | - | - | - | 36,7 | - | - | 34,9 | 107 | - | - | 27,7 | 26,8 | - | - | 25,9 | - | - | | |
| 106 | - | - | - | 35,4 | - | - | 33,0 | 110 | - | - | - | 26,8 | - | - | 25,0 | - | - | | |
| 108 | - | - | - | 34,5 | 30,4 | - | 32,3 | 114 | - | - | - | 26,2 | - | - | 23,8 | - | - | | |
| 110 | - | - | - | 33,7 | 30,4 | 31,5 | 31,5 | 116 | - | - | - | 26,0 | 20,7 | - | 23,2 | - | - | | |
| 114 | - | - | - | - | 30,1 | 29,9 | 29,9 | 118 | - | - | - | 25,6 | 20,7 | 22,6 | - | - | - | | |
| 118 | - | - | - | - | 29,7 | 28,3 | 28,3 | 121 | - | - | - | 24,8 | 20,7 | 21,7 | - | - | - | | |
| 122 | - | - | - | - | 28,5 | 26,2 | 26,2 | 122 | - | - | - | - | 20,7 | 21,3 | - | - | - | | |
| 123 | - | - | - | - | 28,1 | 25,6 | 25,6 | 126 | - | - | - | - | 20,7 | 20,1 | - | - | - | | |
| 126 | - | - | - | - | - | 23,7 | 23,7 | 130 | - | - | - | - | 20,4 | 18,9 | - | - | - | | |
| 130 | - | - | - | - | - | 21,2 | 21,2 | 134 | - | - | - | - | 20,1 | 17,6 | - | - | - | | |
| 134 | - | - | - | - | - | 18,4 | 18,4 | 135 | - | - | - | - | 19,8 | 17,3 | - | - | - | | |
| 138 | - | - | - | - | - | 15,3 | 15,3 | 138 | - | - | - | - | - | 16,3 | - | - | - | | |
| 142 | - | - | - | - | - | 11,8 | 11,8 | 142 | - | - | - | - | - | 13,9 | - | - | - | | |
| 146 | - | - | - | - | - | 8,8 | 8,8 | 146 | - | - | - | - | - | 11,0 | - | - | - | | |
| 150 | - | - | - | - | - | 6,3 | 6,3 | 150 | - | - | - | - | - | 8,0 | - | - | - | | |
| | | | | | | | | 154 | - | - | - | - | - | 5,0 | - | - | - | | |
| | | | | | | | | 156 | - | - | - | - | - | 4,1 | - | - | - | | |

0 t 65 t 125 t 165 t 205 t 245 t 285 t 325 t

* Main boom angle 85° · Hauptauslegerwinkel 85° · Jarret de flèche principale 85° · Inclinação braccio base 85° · Ángulo de pluma principal 85° · Ângulo da lança principal 85° · Угол подъема гл. стрелы 85°

Main boom angle 87°, 85°, 75°, 65° and 55°, capacities for intermediate boom positions are calculated by the crane control system IC-1 · Hauptauslegerwinkel 87°, 85°, 75°, 65° und 55°, Traglasten für Zwischenstellungen des Hauptauslegers werden von der Kransteuerung IC-1 berechnet · Jarret de flèche principale 87°, 85°, 75°, 65° et 55°, le système de commande de la grue IC-1 calcule les charges pour les positions intermédiaires de la flèche · Inclinação braccio base 87°, 85°, 75°, 65° e 55°, capacità per posizioni intermedie del braccio sono calcolate dal sistema di controllo della gru IC-1 · Ángulo de pluma principal 87°, 85°, 75°, 65° y 55°, las capacidades para posiciones de pluma intermedias son calculadas por el sistema de control de grúa IC-1 · Ângulos da lança principal 87°, 85°, 75°, 65° e 55°; as capacidades para posições da lança intermediária são calculadas pelo sistema de controle da grua IC-1 · Грузоподъемность при углах подъема главной стрелы 87°, 85°, 75°, 65° и 55°, грузоподъемность в промежуточных положениях стрелы рассчитывается системой управления краном IC-1

| 165 t + 50 t | | | | | | | | 11-19 m | | 8,40 m | | 9.8 m/s | | 360° | | ISO | | | | | | | | | | | | | |
|--------------|------|-------|------|------|------|---|------|-----------|-------|--------|-------|---------|------|------|----|-----|-------|--------|---|---|---|---|---|---|---|---|---|---|--|
| 90 m + 96 m | | | | | | | | SWSL_1 | | SFSL_1 | | | | | | | | | | | | | | | | | | | |
| 0 t | | | | | | | | 0 t-325 t | | SWSL_1 | | SFSL_1 | | | | | | | | | | | | | | | | | |
| 87°/85° | | | | | | | | 87°/85° | | 75° | | 65° | | 55° | | 15° | | | | | | | | | | | | | |
| m | t | t | t | t | t | t | t | m | t | t | t | t | t | t | t | m | t | t | t | t | t | t | t | t | t | t | t | t | |
| 30 | 29,0 | 30,0 | - | - | - | - | - | 14 | - | 141,0 | - | - | - | - | - | 15 | 128,0 | 139,0 | - | - | - | - | - | - | - | - | - | - | |
| 34 | 28,6 | 29,5 | - | - | - | - | - | 15 | 121,0 | 138,0 | - | - | - | - | - | 16 | 121,0 | 138,0 | - | - | - | - | - | - | - | - | - | - | |
| 38 | 28,2 | 29,2* | - | - | - | - | - | 16 | 110,0 | 140,0* | - | - | - | - | - | 18 | 110,0 | 140,0* | - | - | - | - | - | - | - | - | - | - | |
| 42 | 27,2 | 28,8* | - | - | - | - | - | 18 | 101,0 | 138,0* | - | - | - | - | - | 20 | 101,0 | 138,0* | - | - | - | - | - | - | - | - | - | - | |
| 45 | 24,9 | 28,3* | - | - | - | - | 28,2 | 20 | 93,0 | 135,0* | - | - | - | - | - | 22 | 93,0 | 135,0* | - | - | - | - | - | - | - | - | - | - | |
| 46 | 24,2 | 28,2* | - | - | - | - | 28,1 | 22 | 86,5 | 131,0* | - | - | - | - | - | 24 | 86,5 | 131,0* | - | - | - | - | - | - | - | - | - | - | |
| 50 | 21,0 | 27,6* | - | - | - | - | 27,7 | 24 | 80,5 | 127,0* | - | - | - | - | - | 26 | 80,5 | 127,0* | - | - | - | - | - | - | - | - | - | - | |
| 54 | 18,3 | 27,0* | - | - | - | - | 27,5 | 26 | 75,5 | 123,0* | - | - | - | - | - | 28 | 75,5 | 123,0* | - | - | - | - | - | - | - | - | - | - | |
| 58 | 15,9 | 26,3* | - | - | - | - | 27,0 | 28 | 71,0 | 119,0* | - | - | - | - | - | 30 | 71,0 | 119,0* | - | - | - | - | - | - | - | - | - | - | |
| 62 | 13,7 | 25,5* | - | - | - | - | 26,4 | 30 | 57,5* | 113,0* | - | - | - | - | - | 34 | 57,5* | 113,0* | - | - | - | - | - | - | - | - | - | - | |
| 66 | 11,8 | 24,8* | - | - | - | - | 25,8 | 34 | - | - | - | - | - | - | 38 | - | - | - | - | - | - | - | - | - | - | - | - | - | |
| 68 | 10,9 | 24,4* | 23,5 | - | - | - | 25,5 | 38 | - | - | - | - | - | - | 39 | - | - | 127,0 | - | - | - | - | - | - | - | - | - | - | |
| 70 | 10,0 | 24,0* | 23,5 | - | - | - | 25,2 | 39 | - | - | 127,0 | - | - | - | 42 | - | - | 123,0 | - | - | - | - | - | - | - | - | - | - | |
| 74 | 8,4 | 23,2* | 23,5 | - | - | - | 24,5 | 42 | - | - | 123,0 | - | - | - | 46 | - | - | 116,0 | - | - | - | - | - | - | - | - | - | - | |
| 78 | 7,0 | 22,4* | 23,5 | - | - | - | 23,9 | 46 | - | - | 116,0 | - | - | - | 50 | - | - | 108,0 | - | - | - | - | - | - | - | - | - | - | |
| 82 | 5,7 | 21,6* | 23,5 | - | - | - | 23,1 | 50 | - | - | 108,0 | - | - | - | 54 | - | - | - | - | - | - | - | - | - | - | - | - | - | |
| 86 | 4,5 | 20,8* | 23,4 | - | - | - | 22,4 | 54 | - | - | - | - | - | - | 58 | - | - | - | - | - | - | - | - | - | - | - | - | - | |
| 87 | 4,2 | 20,6* | 23,3 | - | - | - | 22,2 | 58 | - | - | - | - | - | - | 59 | - | - | - | - | - | - | - | - | - | - | - | - | - | |
| 90 | - | 20,0* | 23,1 | - | - | - | 21,7 | 59 | - | - | - | 103,0 | - | - | 62 | - | - | - | - | - | - | - | - | - | - | - | - | - | |
| 94 | - | 19,3* | 22,8 | - | - | - | 20,9 | 62 | - | - | - | 99,0 | - | - | 66 | - | - | - | - | - | - | - | - | - | - | - | - | - | |
| 97 | - | 18,7* | 22,5 | 17,3 | - | - | 20,4 | 66 | - | - | - | 92,0 | - | - | 70 | - | - | - | - | - | - | - | - | - | - | - | - | - | |
| 98 | - | 18,6* | 22,5 | 17,3 | - | - | 20,2 | 70 | - | - | - | - | - | - | 74 | - | - | - | - | - | - | - | - | - | - | - | - | - | |
| 99 | - | 18,4* | 22,3 | 17,3 | - | - | 20,0 | 74 | - | - | - | - | - | - | 77 | - | - | - | - | - | - | - | - | - | - | - | - | - | |
| 102 | - | 17,9* | 22,0 | 17,3 | - | - | 19,5 | 77 | - | - | - | - | 69,5 | - | - | - | - | - | - | - | - | - | - | - | - | - | - | - | |
| 103 | - | 17,8* | 21,8 | 17,3 | - | - | 19,3 | 78 | - | - | - | - | 68,0 | - | - | - | - | - | - | - | - | - | - | - | - | - | - | - | |
| 106 | - | - | 21,4 | 17,3 | - | - | 18,8 | 80 | - | - | - | - | 66,0 | - | - | - | - | - | - | - | - | - | - | - | - | - | - | - | |
| 110 | - | - | 20,8 | 17,3 | - | - | 18,0 | 82 | - | - | - | - | - | - | - | - | - | - | - | - | - | - | - | - | - | - | - | - | |
| 114 | - | - | 20,1 | 17,3 | - | - | 17,3 | 86 | - | - | - | - | - | - | - | - | - | - | - | - | - | - | - | - | - | - | - | - | |
| 118 | - | - | 19,5 | 17,3 | - | - | 16,5 | 90 | - | - | - | - | - | - | - | - | - | - | - | - | - | - | - | - | - | - | - | - | |
| 122 | - | - | - | 17,3 | - | - | 15,6 | 94 | - | - | - | - | - | - | - | - | - | - | - | - | - | - | - | - | - | - | - | - | |
| 125 | - | - | - | 17,3 | 12,5 | - | 15,0 | 98 | - | - | - | - | - | - | - | - | - | - | - | - | - | - | - | - | - | - | - | - | |
| 126 | - | - | - | 17,3 | 12,5 | - | 14,8 | 102 | - | - | - | - | - | - | - | - | - | - | - | - | - | - | - | - | - | - | - | - | |
| 130 | - | - | - | 17,0 | 12,4 | - | 13,9 | 106 | - | - | - | - | - | - | - | - | - | - | - | - | - | - | - | - | - | - | - | - | |
| 133 | - | - | - | 16,7 | 12,4 | - | 13,3 | 109 | - | - | - | - | - | - | - | - | - | - | - | - | - | - | - | - | - | - | - | - | |
| 134 | - | - | - | - | 12,4 | - | 13,0 | | | | | | | | | | | | | | | | | | | | | | |
| 138 | - | - | - | - | 12,4 | - | 11,9 | | | | | | | | | | | | | | | | | | | | | | |
| 142 | - | - | - | - | 12,4 | - | 11,0 | | | | | | | | | | | | | | | | | | | | | | |
| 146 | - | - | - | - | 12,4 | - | 10,0 | | | | | | | | | | | | | | | | | | | | | | |
| 147 | - | - | - | - | 12,2 | - | 9,8 | | | | | | | | | | | | | | | | | | | | | | |
| 150 | - | - | - | - | - | - | 9,0 | | | | | | | | | | | | | | | | | | | | | | |
| 154 | - | - | - | - | - | - | 6,7 | | | | | | | | | | | | | | | | | | | | | | |
| 158 | - | - | - | - | - | - | 4,2 | | | | | | | | | | | | | | | | | | | | | | |

0t 65t 125t 165t 205t 245t 285t 325t

* Main boom angle 85° · Hauptauslegerwinkel 85° · Jarret de flèche principale 85° · Inclinazione braccio base 85° · Ángulo de pluma principal 85° · Ángulo da lança principal 85° · Угол подъема гл. стрелы 85°

Main boom angle 87°, 85°, 75°, 65° and 55°, capacities for intermediate boom positions are calculated by the crane control system IC-1 · Hauptauslegerwinkel 87°, 85°, 75°, 65° und 55°, Traglasten für Zwischenstellungen des Hauptauslegers werden von der Kransteuerung IC-1 berechnet · Jarret de flèche principale 87°, 85°, 75°, 65° et 55°, le système de commande de la grue IC-1 calcule les charges pour les positions intermédiaires de la flèche · Inclinazione braccio base 87°, 85°, 75°, 65° e 55°, capacità per posizioni intermedie del braccio sono calcolate dal sistema di controllo della gru IC-1 · Ángulo de pluma principal 87°, 85°, 75°, 65° y 55°, las capacidades para posiciones de pluma intermedias son calculadas por el sistema de control de grúa IC-1 · Ángulos da lança principal 87°, 85°, 75°, 65° e 55°; as capacidades para posições da lança intermediária são calculadas pelo sistema de controle da grua IC-1 · Грузоподъемность при углах подъема главной стрелы 87°, 85°, 75°, 65° и 55°, грузоподъемность в промежуточных положениях стрелы рассчитывается системой управления краном IC-1

| 165 t + 50 t | | | | | | | | 11-19 m | | 8,40 m | | 9.8 m/s | | 360° | | ISO | | | |
|--------------|-------|--------|------|------|------|---|-------|-----------|-------|--------|------|---------|---|------|------|------|---|--|--|
| 96 m + 36 m | | | | | | | | | | | | | | | | | | | |
| SWSL_1 | | | | | | | | SFSL_1 | | | | | | | | | | | |
| 0 t | | | | | | | | 0 t-325 t | | | | | | | | | | | |
| 87°/85° | | | | | | | | 87°/85° | | 75° | | 65° | | 55° | | 15° | | | |
| m | t | t | t | t | t | t | t | m | t | t | t | t | t | t | t | t | t | | |
| 17 | 104,0 | 108,0 | - | - | - | - | - | 20 | 81,5 | 83,5 | - | - | - | - | - | - | - | | |
| 18 | 102,0 | 107,0 | - | - | - | - | - | 22 | 79,0 | 82,0 | - | - | - | - | - | - | - | | |
| 20 | 93,5 | 104,0 | - | - | - | - | - | 24 | 73,0 | 80,5 | - | - | - | - | - | - | - | | |
| 22 | 86,0 | 107,0* | - | - | - | - | - | 26 | 68,0 | 82,5* | - | - | - | - | - | - | - | | |
| 24 | 79,5 | 105,0* | - | - | - | - | - | 28 | 63,5 | 81,5* | - | - | - | - | - | - | - | | |
| 25 | 76,7 | 104,0* | - | - | - | - | 103,0 | 29 | 61,2 | 80,7* | - | - | - | - | - | 80,0 | - | | |
| 26 | 74,0 | 103,0* | - | - | - | - | 103,0 | 30 | 59,0 | 80,0* | - | - | - | - | - | 79,5 | - | | |
| 28 | 69,0 | 100,0* | - | - | - | - | 103,0 | 34 | 52,0 | 76,5* | - | - | - | - | - | 79,1 | - | | |
| 30 | 65,0 | 98,0* | - | - | - | - | 102,0 | 38 | 46,6 | 73,0* | - | - | - | - | - | 78,3 | - | | |
| 34 | 57,5 | 92,5* | - | - | - | - | 100,6 | 42 | 41,7 | 69,5* | - | - | - | - | - | 77,0 | - | | |
| 38 | 51,5 | 87,5* | - | - | - | - | 99,1 | 46 | 37,7 | 66,5* | - | - | - | - | - | 75,6 | - | | |
| 42 | 46,7 | 83,0* | - | - | - | - | 97,5 | 49 | 35,0 | 64,2* | 74,5 | - | - | - | - | 74,5 | - | | |
| 44 | 39,9* | 81,3* | 96,5 | - | - | - | 96,1 | 50 | 34,2 | 63,5* | 74,0 | - | - | - | - | 74,1 | - | | |
| 45 | 38,9* | 80,5* | 96,0 | - | - | - | 95,5 | 53 | 31,9 | 61,2* | 73,0 | - | - | - | - | 72,9 | - | | |
| 46 | - | - | 95,5 | - | - | - | 94,8 | 54 | 27,4* | 60,5* | 72,5 | - | - | - | - | 72,5 | - | | |
| 50 | - | - | 91,5 | - | - | - | 92,1 | 57 | 25,5* | 59,0* | 70,6 | - | - | - | - | 71,0 | - | | |
| 54 | - | - | 87,0 | - | - | - | 89,5 | 58 | - | - | 70,0 | - | - | - | - | 70,5 | - | | |
| 58 | - | - | 82,5 | - | - | - | 86,1 | 62 | - | - | 67,5 | - | - | - | - | 68,3 | - | | |
| 62 | - | - | 77,5 | - | - | - | 82,8 | 66 | - | - | 64,5 | - | - | - | - | 66,0 | - | | |
| 66 | - | - | - | 79,5 | - | - | 79,5 | 70 | - | - | 61,5 | - | - | - | - | 63,6 | - | | |
| 70 | - | - | - | 76,0 | - | - | 75,6 | 73 | - | - | 59,0 | 59,0 | - | - | - | 61,8 | - | | |
| 74 | - | - | - | 72,0 | - | - | 72,3 | 74 | - | - | 59,0 | - | - | - | - | 61,1 | - | | |
| 78 | - | - | - | 67,0 | - | - | 69,0 | 78 | - | - | 57,0 | - | - | - | - | 58,5 | - | | |
| 82 | - | - | - | - | - | - | 63,0 | 82 | - | - | 54,5 | - | - | - | - | 55,8 | - | | |
| 86 | - | - | - | - | 57,5 | - | 57,3 | 86 | - | - | 51,5 | - | - | - | - | 53,1 | - | | |
| 90 | - | - | - | - | 54,0 | - | 52,0 | 89 | - | - | 49,4 | - | - | - | - | 51,1 | - | | |
| 92 | - | - | - | - | 52,5 | - | 49,7 | 90 | - | - | - | - | - | - | - | 50,5 | - | | |
| 94 | - | - | - | - | - | - | 47,5 | 94 | - | - | - | - | - | - | 45,6 | 47,4 | - | | |
| 98 | - | - | - | - | - | - | 43,2 | 98 | - | - | - | - | - | - | 43,8 | 43,7 | - | | |
| 102 | - | - | - | - | - | - | 39,2 | 102 | - | - | - | - | - | - | 41,4 | 39,7 | - | | |
| 106 | - | - | - | - | - | - | 35,6 | 104 | - | - | - | - | - | - | 40,1 | 37,8 | - | | |
| 110 | - | - | - | - | - | - | 32,0 | 106 | - | - | - | - | - | - | - | 36,0 | - | | |
| 114 | - | - | - | - | - | - | 27,3 | 110 | - | - | - | - | - | - | - | 32,5 | - | | |
| 118 | - | - | - | - | - | - | 22,3 | 114 | - | - | - | - | - | - | - | 29,4 | - | | |
| 120 | - | - | - | - | - | - | 20,1 | 118 | - | - | - | - | - | - | - | 26,4 | - | | |
| | | | | | | | | 122 | - | - | - | - | - | - | - | 22,8 | - | | |
| | | | | | | | | 126 | - | - | - | - | - | - | - | 18,5 | - | | |
| | | | | | | | | 130 | - | - | - | - | - | - | - | 14,3 | - | | |
| | | | | | | | | 132 | - | - | - | - | - | - | - | 13,2 | - | | |

* Main boom angle 85° · Hauptauslegerwinkel 85° · Jarret de flèche principale 85° · Inclinazione braccio base 85° · Ángulo de pluma principal 85° · Ângulo da lança principal 85° · Угол подъема гл. стрелы 85°

Main boom angle 87°, 85°, 75°, 65° and 55°, capacities for intermediate boom positions are calculated by the crane control system IC-1 · Hauptauslegerwinkel 87°, 85°, 75°, 65° und 55°, Traglasten für Zwischenstellungen des Hauptauslegers werden von der Kransteuerung IC-1 berechnet · Jarret de flèche principale 87°, 85°, 75°, 65° et 55°, le système de commande de la grue IC-1 calcule les charges pour les positions intermédiaires de la flèche · Inclinazione braccio base 87°, 85°, 75°, 65° e 55°, capacità per posizioni intermedie del braccio sono calcolate dal sistema di controllo della gru IC-1 · Ángulo de pluma principal 87°, 85°, 75°, 65° y 55°, las capacidades para posiciones de pluma intermedias son calculadas por el sistema de control de grúa IC-1 · Ângulos da lança principal 87°, 85°, 75°, 65° e 55°; as capacidades para posições da lança intermediária são calculadas pelo sistema de controle da grua IC-1 · Грузоподъемность при углах подъема главной стрелы 87°, 85°, 75°, 65° и 55°, грузоподъемность в промежуточных положениях стрелы рассчитывается системой управления краном IC-1

| 165 t + 50 t | | 11-19 m | | 8,40 m | | 9.8 m/s | | 360° | | ISO | |
|--------------|-------|-----------|------|--------|------|-------------|---|--------|---|-----------|---|
| 96 m + 60 m | | SWSL_1 | | SFSL_1 | | 96 m + 72 m | | SWSL_1 | | SFSL_1 | |
| 0 t | | 0 t-325 t | | 0 t | | 0 t-325 t | | 0 t | | 0 t-325 t | |
| 87°/85° | | 87°/85° | | 75° | | 65° | | 55° | | 15° | |
| m | t | t | t | t | t | t | t | t | t | t | t |
| 22 | 62,5 | 64,0 | - | - | - | - | - | - | - | - | - |
| 24 | 62,0 | 63,5 | - | - | - | - | - | - | - | - | - |
| 26 | 60,5 | 62,5 | - | - | - | - | - | - | - | - | - |
| 28 | 58,5 | 63,5* | - | - | - | - | - | - | - | - | - |
| 30 | 54,5 | 62,5* | - | - | - | - | - | - | - | - | - |
| 33 | 49,5 | 61,3* | - | - | - | - | - | - | - | 61,0 | - |
| 34 | 47,9 | 61,0* | - | - | - | - | - | - | - | 60,8 | - |
| 38 | 42,4 | 58,5* | - | - | - | - | - | - | - | 60,3 | - |
| 42 | 37,8 | 56,5* | - | - | - | - | - | - | - | 60,0 | - |
| 46 | 33,8 | 54,5* | - | - | - | - | - | - | - | 58,6 | - |
| 50 | 30,4 | 52,0* | - | - | - | - | - | - | - | 57,5 | - |
| 54 | 27,4 | 49,9* | 55,5 | - | - | - | - | - | - | 56,5 | - |
| 58 | 24,9 | 47,7* | 55,0 | - | - | - | - | - | - | 55,1 | - |
| 62 | 22,6 | 45,7* | 54,0 | - | - | - | - | - | - | 53,6 | - |
| 65 | 21,1 | 44,4* | 52,8 | - | - | - | - | - | - | 52,4 | - |
| 66 | 17,3* | 44,0* | 52,5 | - | - | - | - | - | - | 52,0 | - |
| 68 | 16,5* | 43,2* | 51,5 | - | - | - | - | - | - | 51,2 | - |
| 70 | - | - | 50,5 | - | - | - | - | - | - | 50,5 | - |
| 74 | - | - | 48,8 | - | - | - | - | - | - | 48,9 | - |
| 78 | - | - | 46,7 | - | - | - | - | - | - | 47,1 | - |
| 79 | - | - | 46,1 | 45,0 | - | - | - | - | - | 46,6 | - |
| 82 | - | - | 44,4 | 44,8 | - | - | - | - | - | 45,3 | - |
| 85 | - | - | 42,6 | 44,0 | - | - | - | - | - | 43,9 | - |
| 86 | - | - | - | 43,8 | - | - | - | - | - | 43,5 | - |
| 90 | - | - | - | 42,3 | - | - | - | - | - | 41,7 | - |
| 94 | - | - | - | 40,4 | - | - | - | - | - | 39,8 | - |
| 98 | - | - | - | 38,4 | - | - | - | - | - | 37,6 | - |
| 101 | - | - | - | 36,6 | - | - | - | - | - | 36,1 | - |
| 102 | - | - | - | - | - | - | - | - | - | 35,5 | - |
| 103 | - | - | - | - | - | - | - | - | - | 34,9 | - |
| 106 | - | - | - | - | - | - | - | - | - | 33,3 | - |
| 110 | - | - | - | - | - | - | - | - | - | 31,8 | - |
| 114 | - | - | - | - | - | - | - | - | - | 30,1 | - |
| 115 | - | - | - | - | - | - | - | - | - | 29,6 | - |
| 118 | - | - | - | - | - | - | - | - | - | 28,5 | - |
| 122 | - | - | - | - | - | - | - | - | - | 26,7 | - |
| 126 | - | - | - | - | - | - | - | - | - | 24,2 | - |
| 130 | - | - | - | - | - | - | - | - | - | 21,6 | - |
| 134 | - | - | - | - | - | - | - | - | - | 18,4 | - |
| 138 | - | - | - | - | - | - | - | - | - | 14,9 | - |
| 142 | - | - | - | - | - | - | - | - | - | 11,3 | - |
| 143 | - | - | - | - | - | - | - | - | - | 8,6 | - |
| 146 | - | - | - | - | - | - | - | - | - | 8,2 | - |
| 25 | 48,0 | 49,4 | - | - | - | - | - | - | - | - | - |
| 26 | 47,8 | 49,1 | - | - | - | - | - | - | - | - | - |
| 28 | 47,3 | 48,5 | - | - | - | - | - | - | - | - | - |
| 30 | 46,9 | 47,8 | - | - | - | - | - | - | - | - | - |
| 34 | 43,5 | 48,0* | - | - | - | - | - | - | - | - | - |
| 37 | 39,5 | 47,1* | - | - | - | - | - | - | - | 46,7 | - |
| 38 | 38,2 | 46,8* | - | - | - | - | - | - | - | 46,6 | - |
| 42 | 33,8 | 45,5* | - | - | - | - | - | - | - | 46,2 | - |
| 46 | 30,0 | 44,0* | - | - | - | - | - | - | - | 45,7 | - |
| 50 | 26,7 | 42,5* | - | - | - | - | - | - | - | 45,1 | - |
| 54 | 23,9 | 40,9* | - | - | - | - | - | - | - | 44,3 | - |
| 58 | 21,4 | 39,3* | - | - | - | - | - | - | - | 43,4 | - |
| 59 | 20,8 | 38,9* | 41,9 | - | - | - | - | - | - | 43,2 | - |
| 62 | 19,2 | 37,8* | 41,8 | - | - | - | - | - | - | 42,4 | - |
| 66 | 17,2 | 36,2* | 41,3 | - | - | - | - | - | - | 41,4 | - |
| 70 | 15,4 | 34,8* | 40,6 | - | - | - | - | - | - | 40,2 | - |
| 74 | 13,9 | 33,5* | 39,7 | - | - | - | - | - | - | 39,0 | - |
| 77 | 12,8 | 32,5* | 38,8 | - | - | - | - | - | - | 38,1 | - |
| 78 | 9,6* | 32,2* | 38,6 | - | - | - | - | - | - | 37,8 | - |
| 80 | 9,0* | 31,7* | 38,0 | - | - | - | - | - | - | 37,0 | - |
| 82 | - | - | 37,4 | - | - | - | - | - | - | 36,3 | - |
| 86 | - | - | 35,9 | 33,0 | - | - | - | - | - | 35,0 | - |
| 90 | - | - | 34,5 | 33,0 | - | - | - | - | - | 33,7 | - |
| 94 | - | - | 32,9 | 32,7 | - | - | - | - | - | 32,3 | - |
| 97 | - | - | 31,6 | 32,0 | - | - | - | - | - | 31,2 | - |
| 98 | - | - | - | 31,8 | - | - | - | - | - | 30,9 | - |
| 102 | - | - | - | 30,8 | - | - | - | - | - | 29,5 | - |
| 106 | - | - | - | 29,4 | - | - | - | - | - | 27,9 | - |
| 110 | - | - | - | 28,0 | - | - | - | - | - | 26,4 | - |
| 111 | - | - | - | 27,6 | 24,5 | - | - | - | - | 26,0 | - |
| 112 | - | - | - | 27,2 | 24,5 | - | - | - | - | 25,6 | - |
| 114 | - | - | - | - | 24,4 | - | - | - | - | 24,8 | - |
| 118 | - | - | - | - | 23,6 | - | - | - | - | 22,9 | - |
| 122 | - | - | - | - | 22,6 | - | - | - | - | 21,3 | - |
| 126 | - | - | - | - | 21,3 | - | - | - | - | 19,7 | - |
| 127 | - | - | - | - | 20,9 | - | - | - | - | 19,2 | - |
| 130 | - | - | - | - | - | - | - | - | - | 17,9 | - |
| 134 | - | - | - | - | - | - | - | - | - | 16,1 | - |
| 138 | - | - | - | - | - | - | - | - | - | 14,3 | - |
| 142 | - | - | - | - | - | - | - | - | - | 11,3 | - |
| 146 | - | - | - | - | - | - | - | - | - | 8,2 | - |
| 150 | - | - | - | - | - | - | - | - | - | 5,2 | - |
| 152 | - | - | - | - | - | - | - | - | - | 4,4 | - |

0 t 65 t 125 t 165 t 205 t 245 t 285 t 325 t

* Main boom angle 85° · Hauptauslegerwinkel 85° · Jarret de flèche principale 85° · Inclinazione braccio base 85° · Ángulo de pluma principal 85° · Ângulo da lança principal 85° · Угол подъема гл. стрелы 85°

Main boom angle 87°, 85°, 75°, 65° and 55°, capacities for intermediate boom positions are calculated by the crane control system IC-1 · Hauptauslegerwinkel 87°, 85°, 75°, 65° und 55°, Traglasten für Zwischenstellungen des Hauptauslegers werden von der Kransteuerung IC-1 berechnet · Jarret de flèche principale 87°, 85°, 75°, 65° et 55°, le système de commande de la grue IC-1 calcule les charges pour les positions intermédiaires de la flèche · Inclinazione braccio base 87°, 85°, 75°, 65° e 55°, capacità per posizioni intermedie del braccio sono calcolate dal sistema di controllo della gru IC-1 · Ángulo de pluma principal 87°, 85°, 75°, 65° y 55°, las capacidades para posiciones de pluma intermedias son calculadas por el sistema de control de grúa IC-1 · Ângulos da lança principal 87°, 85°, 75°, 65° e 55°; as capacidades para posições da lança intermediária são calculadas pelo sistema de controle da grua IC-1 · Грузоподъемность при углах подъема главной стрелы 87°, 85°, 75°, 65° и 55°, грузоподъемность в промежуточных положениях стрелы рассчитывается системой управления краном IC-1

| 165 t + 50 t | | 11-19 m | | 8,40 m | | 9.8 m/s | | 360° | | ISO | |
|--------------|------|-----------|------|--------|------|-------------|---|--------|---|-----------|---|
| 96 m + 84 m | | SWSL_1 | | SFSL_1 | | 96 m + 96 m | | SWSL_1 | | SFSL_1 | |
| 0 t | | 0 t-325 t | | 0 t | | 0 t-325 t | | 0 t | | 0 t-325 t | |
| 87°/85° | | 87°/85° | | 75° | | 65° | | 55° | | 15° | |
| m | t | t | t | t | t | t | t | t | t | t | t |
| 28 | 35,9 | 37,1 | - | - | - | - | - | - | - | - | - |
| 30 | 35,6 | 36,7 | - | - | - | - | - | - | - | - | - |
| 34 | 35,0 | 36,4* | - | - | - | - | - | - | - | - | - |
| 38 | 33,7 | 35,8* | - | - | - | - | - | - | - | - | - |
| 41 | 30,7 | 35,2* | - | - | - | - | - | - | - | 34,9 | - |
| 42 | 29,8 | 35,1* | - | - | - | - | - | - | - | 34,8 | - |
| 46 | 26,2 | 34,2* | - | - | - | - | - | - | - | 34,5 | - |
| 50 | 23,1 | 33,2* | - | - | - | - | - | - | - | 34,1 | - |
| 54 | 20,3 | 32,2* | - | - | - | - | - | - | - | 33,6 | - |
| 58 | 17,9 | 31,1* | - | - | - | - | - | - | - | 32,9 | - |
| 62 | 15,7 | 30,0* | - | - | - | - | - | - | - | 32,2 | - |
| 64 | 14,7 | 29,4* | 30,2 | - | - | - | - | - | - | 31,9 | - |
| 66 | 13,8 | 28,9* | 30,2 | - | - | - | - | - | - | 31,6 | - |
| 70 | 12,1 | 27,8* | 30,2 | - | - | - | - | - | - | 30,7 | - |
| 74 | 10,5 | 26,7* | 30,1 | - | - | - | - | - | - | 29,8 | - |
| 78 | 9,1 | 25,7* | 29,6 | - | - | - | - | - | - | 29,0 | - |
| 82 | 7,8 | 24,7* | 29,0 | - | - | - | - | - | - | 28,0 | - |
| 86 | 6,7 | 23,7* | 28,3 | - | - | - | - | - | - | 27,0 | - |
| 88 | 6,2 | 23,3* | 27,9 | - | - | - | - | - | - | 26,5 | - |
| 90 | - | 22,9* | 27,6 | - | - | - | - | - | - | 26,0 | - |
| 92 | - | 22,4* | 27,1 | - | - | - | - | - | - | 25,5 | - |
| 93 | - | - | 26,8 | 23,0 | - | - | - | - | - | 25,2 | - |
| 94 | - | - | 26,6 | 23,0 | - | - | - | - | - | 25,0 | - |
| 98 | - | - | 25,7 | 23,0 | - | - | - | - | - | 23,9 | - |
| 102 | - | - | 24,6 | 23,0 | - | - | - | - | - | 22,9 | - |
| 106 | - | - | 23,5 | 22,8 | - | - | - | - | - | 21,9 | - |
| 108 | - | - | 23,0 | 22,5 | - | - | - | - | - | 21,4 | - |
| 110 | - | - | - | 22,2 | - | - | - | - | - | 20,8 | - |
| 114 | - | - | - | 21,5 | - | - | - | - | - | 19,7 | - |
| 118 | - | - | - | 20,5 | - | - | - | - | - | 18,4 | - |
| 120 | - | - | - | 20,0 | 16,2 | - | - | - | - | 17,8 | - |
| 122 | - | - | - | 19,5 | 16,2 | - | - | - | - | 17,2 | - |
| 124 | - | - | - | 18,9 | 16,1 | 16,6 | - | - | - | 16,6 | - |
| 126 | - | - | - | - | 16,1 | 16,0 | - | - | - | 16,0 | - |
| 130 | - | - | - | - | 15,6 | 14,7 | - | - | - | 14,7 | - |
| 134 | - | - | - | - | 14,8 | 13,1 | - | - | - | 13,1 | - |
| 138 | - | - | - | - | 13,9 | 11,9 | - | - | - | 11,9 | - |
| 142 | - | - | - | - | - | 8,6 | - | - | - | 8,6 | - |
| 146 | - | - | - | - | - | 6,7 | - | - | - | 6,7 | - |
| 150 | - | - | - | - | - | 4,9 | - | - | - | 4,9 | - |
| 152 | - | - | - | - | - | 4,1 | - | - | - | 4,1 | - |
| 30 | 25,9 | 27,0 | - | - | - | - | - | - | - | - | - |
| 34 | 25,5 | 26,4 | - | - | - | - | - | - | - | - | - |
| 38 | 25,1 | 26,1* | - | - | - | - | - | - | - | - | - |
| 42 | 24,4 | 25,7* | - | - | - | - | - | - | - | - | - |
| 45 | 22,9 | 25,2* | - | - | - | - | - | - | - | 25,0 | - |
| 46 | 22,5 | 25,1* | - | - | - | - | - | - | - | 24,9 | - |
| 50 | 19,5 | 24,5* | - | - | - | - | - | - | - | 24,6 | - |
| 54 | 16,9 | 23,8* | - | - | - | - | - | - | - | 24,3 | - |
| 58 | 14,6 | 23,2* | - | - | - | - | - | - | - | 23,9 | - |
| 62 | 12,5 | 22,4* | - | - | - | - | - | - | - | 23,3 | - |
| 66 | 10,6 | 21,7* | - | - | - | - | - | - | - | 22,7 | - |
| 69 | 9,3 | 21,1* | 20,5 | - | - | - | - | - | - | 22,3 | - |
| 70 | 8,9 | 20,9* | 20,5 | - | - | - | - | - | - | 22,1 | - |
| 74 | 7,4 | 20,1* | 20,5 | - | - | - | - | - | - | 21,5 | - |
| 78 | 6,0 | 19,3* | 20,5 | - | - | - | - | - | - | 20,8 | - |
| 82 | 4,8 | 18,5* | 20,5 | - | - | - | - | - | - | 20,1 | - |
| 84 | 4,2 | 18,1* | 20,4 | - | - | - | - | - | - | 19,8 | - |
| 86 | - | 17,7* | 20,3 | - | - | - | - | - | - | 19,4 | - |
| 90 | - | 17,0* | 19,9 | - | - | - | - | - | - | 18,7 | - |
| 94 | - | 16,3* | 19,4 | - | - | - | - | - | - | 17,9 | - |
| 98 | - | 15,6* | 18,9 | - | - | - | - | - | - | 17,1 | - |
| 100 | - | 15,2* | 18,6 | 14,4 | - | - | - | - | - | 16,7 | - |
| 102 | - | 14,9* | 18,3 | 14,4 | - | - | - | - | - | 16,3 | - |
| 103 | - | 14,8* | 18,1 | 14,4 | - | - | - | - | - | 16,1 | - |
| 106 | - | - | 17,6 | 14,4 | - | - | - | - | - | 15,5 | - |
| 110 | - | - | 17,0 | 14,4 | - | - | - | - | - | 14,8 | - |
| 114 | - | - | 16,3 | 14,4 | - | - | - | - | - | 14,0 | - |
| 118 | - | - | 15,6 | 14,3 | - | - | - | - | - | 13,2 | - |
| 120 | - | - | 15,2 | 14,2 | - | - | - | - | - | 12,8 | - |
| 122 | - | - | - | 14,2 | - | - | - | - | - | 12,3 | - |
| 126 | - | - | - | 13,6 | - | - | - | - | - | 11,4 | - |
| 129 | - | - | - | 13,1 | 9,1 | - | - | - | - | 10,7 | - |
| 130 | - | - | - | 13,0 | 9,1 | 10,4 | - | - | - | 10,4 | - |
| 134 | - | - | - | 12,2 | 9,0 | 9,4 | - | - | - | 9,4 | - |
| 135 | - | - | - | 12,0 | 8,9 | 9,2 | - | - | - | 9,2 | - |
| 138 | - | - | - | - | 8,9 | 8,5 | - | - | - | 8,5 | - |
| 142 | - | - | - | - | 8,7 | 7,5 | - | - | - | 7,5 | - |
| 146 | - | - | - | - | 8,1 | 6,3 | - | - | - | 6,3 | - |
| 150 | - | - | - | - | 7,4 | 5,3 | - | - | - | 5,3 | - |
| 153 | - | - | - | - | - | 4,3 | - | - | - | 4,3 | - |

0 t 65 t 125 t 165 t 205 t 245 t 285 t 325 t

* Main boom angle 85° · Hauptauslegerwinkel 85° · Jarret de flèche principale 85° · Inclinazione braccio base 85° · Ángulo de pluma principal 85° · Ángulo da lança principal 85° · Угол подъема гл. стрелы 85°

Main boom angle 87°, 85°, 75°, 65° and 55°, capacities for intermediate boom positions are calculated by the crane control system IC-1 · Hauptauslegerwinkel 87°, 85°, 75°, 65° und 55°, Traglasten für Zwischenstellungen des Hauptauslegers werden von der Kransteuerung IC-1 berechnet · Jarret de flèche principale 87°, 85°, 75°, 65° et 55°, le système de commande de la grue IC-1 calcule les charges pour les positions intermédiaires de la flèche · Inclinazione braccio base 87°, 85°, 75°, 65° e 55°, capacità per posizioni intermedie del braccio sono calcolate dal sistema di controllo della gru IC-1 · Ángulo de pluma principal 87°, 85°, 75°, 65° y 55°, las capacidades para posiciones de pluma intermedias son calculadas por el sistema de control de grúa IC-1 · Ángulos da lança principal 87°, 85°, 75°, 65° e 55°; as capacidades para posições da lança intermediária são calculadas pelo sistema de controle da grua IC-1 · Грузоподъемность при углах подъема главной стрелы 87°, 85°, 75°, 65° и 55°, грузоподъемность в промежуточных положениях стрелы рассчитывается системой управления краном IC-1

| 165 t + 50 t | | 11-19 m | | 8,40 m | | 9.8 m/s | | 360° | | ISO | |
|--------------|-------|-----------|------|--------|------|--------------|-------|-----------|------|------|------|
| 102 m + 36 m | | | | | | 102 m + 48 m | | | | | |
| SWSL_1 | | | | | | SWSL_1 | | | | | |
| SFSL_1 | | | | | | SFSL_1 | | | | | |
| 0 t | | 0 t-325 t | | | | 0 t | | 0 t-325 t | | | |
| 87°/85° | | 87°/85° | | 75° | | 65° | | 55° | | 15° | |
| m | t | t | t | t | t | m | t | t | t | t | t |
| 17 | 94,0 | 97,5 | - | - | - | 20 | 74,0 | 75,5 | - | - | - |
| 18 | 94,0 | 96,5 | - | - | - | 22 | 72,5 | 74,5 | - | - | - |
| 20 | 89,0 | 94,5 | - | - | - | 24 | 70,0 | 73,0 | - | - | - |
| 22 | 82,0 | 97,0* | - | - | - | 26 | 65,0 | 74,5* | - | - | - |
| 24 | 76,0 | 95,0* | - | - | - | 28 | 60,5 | 73,5* | - | - | - |
| 25 | 73,5 | 94,0* | - | - | - | 29 | 58,5 | 72,7* | - | - | 70,5 |
| 26 | 71,0 | 93,0* | - | - | - | 30 | 56,5 | 72,0* | - | - | 70,5 |
| 28 | 66,5 | 90,5* | - | - | - | 34 | 50,0 | 69,0* | - | - | 69,8 |
| 30 | 62,0 | 88,5* | - | - | - | 38 | 44,5 | 66,0* | - | - | 68,8 |
| 34 | 55,0 | 83,5* | - | - | - | 42 | 39,9 | 63,0* | - | - | 67,5 |
| 38 | 49,4 | 79,0* | - | - | - | 46 | 35,9 | 60,0* | - | - | 66,1 |
| 42 | 44,8 | 75,0* | - | - | - | 50 | 32,6 | 57,0* | - | - | 64,6 |
| 46 | 36,0* | 72,0* | 85,0 | - | - | 51 | 31,9 | 56,3* | 64,0 | - | 64,2 |
| 50 | - | - | 82,0 | - | - | 54 | 29,8 | 54,5* | 63,0 | - | 63,0 |
| 54 | - | - | 78,0 | - | - | 57 | 23,9* | 53,5* | 61,5 | - | 61,5 |
| 58 | - | - | 74,0 | - | - | 58 | - | - | 61,0 | - | 61,0 |
| 62 | - | - | 69,5 | - | - | 62 | - | - | 58,0 | - | 58,8 |
| 63 | - | - | 68,5 | - | - | 66 | - | - | 55,5 | - | 56,5 |
| 66 | - | - | - | - | - | 70 | - | - | 52,5 | - | 54,1 |
| 69 | - | - | - | 65,0 | - | 74 | - | - | 49,8 | - | 51,8 |
| 70 | - | - | - | 64,5 | - | 75 | - | - | 49,1 | 50,5 | 51,2 |
| 74 | - | - | - | 61,0 | - | 78 | - | - | - | 49,5 | 49,4 |
| 78 | - | - | - | 57,0 | - | 82 | - | - | - | 47,4 | 47,0 |
| 80 | - | - | - | 54,5 | - | 86 | - | - | - | 44,8 | 44,5 |
| 82 | - | - | - | - | - | 90 | - | - | - | 42,1 | 42,1 |
| 86 | - | - | - | - | - | 92 | - | - | 40,6 | - | 40,9 |
| 89 | - | - | - | - | 48,5 | 94 | - | - | - | - | 39,6 |
| 90 | - | - | - | - | 47,8 | 98 | - | - | - | - | 36,9 |
| 94 | - | - | - | - | 44,6 | 102 | - | - | - | - | 34,4 |
| 96 | - | - | - | - | 42,9 | 106 | - | - | - | - | 31,8 |
| 98 | - | - | - | - | - | 107 | - | - | - | - | 31,2 |
| 102 | - | - | - | - | - | 110 | - | - | - | - | 29,3 |
| 106 | - | - | - | - | - | 114 | - | - | - | - | 26,8 |
| 110 | - | - | - | - | - | 118 | - | - | - | - | 24,1 |
| 114 | - | - | - | - | - | 122 | - | - | - | - | 21,3 |
| 118 | - | - | - | - | - | 126 | - | - | - | - | 18,4 |
| 122 | - | - | - | - | - | 130 | - | - | - | - | 14,5 |
| 125 | - | - | - | - | - | 134 | - | - | - | - | 10,6 |
| | | | | | | 137 | - | - | - | - | 8,9 |

0 t 65 t 125 t 165 t 205 t 245 t 285 t 325 t

* Main boom angle 85° · Hauptauslegerwinkel 85° · Jarret de flèche principale 85° · Inclinazione braccio base 85° · Ángulo de pluma principal 85° · Ângulo da lança principal 85° · Угол подъема гл. стрелы 85°

Main boom angle 87°, 85°, 75°, 65° and 55°, capacities for intermediate boom positions are calculated by the crane control system IC-1 · Hauptauslegerwinkel 87°, 85°, 75°, 65° und 55°, Traglasten für Zwischenstellungen des Hauptauslegers werden von der Kransteuerung IC-1 berechnet · Jarret de flèche principale 87°, 85°, 75°, 65° et 55°, le système de commande de la grue IC-1 calcule les charges pour les positions intermédiaires de la flèche · Inclinazione braccio base 87°, 85°, 75°, 65° e 55°, capacità per posizioni intermedie del braccio sono calcolate dal sistema di controllo della gru IC-1 · Ángulo de pluma principal 87°, 85°, 75°, 65° y 55°, las capacidades para posiciones de pluma intermedias son calculadas por el sistema de control de grúa IC-1 · Ângulos da lança principal 87°, 85°, 75°, 65° e 55°; as capacidades para posições da lança intermediária são calculadas pelo sistema de controle da grua IC-1 · Грузоподъемность при углах подъема главной стрелы 87°, 85°, 75°, 65° и 55°, грузоподъемность в промежуточных положениях стрелы рассчитывается системой управления краном IC-1

| 165 t + 50 t | | 11-19 m | | 8,40 m | | 9.8 m/s | | 360° | | ISO | |
|--------------|-------|---------|------|--------|------|--------------|---|------|---|------|---|
| 102 m + 60 m | | | | | | 102 m + 72 m | | | | | |
| SWSL_1 | | | | | | SWSL_1 | | | | | |
| 0 t | | | | | | 0 t-325 t | | | | | |
| 87°/85° | | 87°/85° | | 75° | | 65° | | 55° | | 15° | |
| m | t | t | t | t | t | t | t | t | t | t | t |
| 23 | 56,5 | 58,0 | - | - | - | - | - | - | - | - | - |
| 24 | 56,0 | 57,5 | - | - | - | - | - | - | - | - | - |
| 26 | 55,0 | 56,5 | - | - | - | - | - | - | - | - | - |
| 28 | 54,0 | 57,5* | - | - | - | - | - | - | - | - | - |
| 30 | 52,0 | 56,5* | - | - | - | - | - | - | - | - | - |
| 33 | 47,2 | 55,3* | - | - | - | - | - | - | - | 54,5 | - |
| 34 | 45,6 | 55,0* | - | - | - | - | - | - | - | 54,3 | - |
| 38 | 40,3 | 53,0* | - | - | - | - | - | - | - | 53,8 | - |
| 42 | 35,9 | 51,0* | - | - | - | - | - | - | - | 53,5 | - |
| 46 | 32,1 | 48,9* | - | - | - | - | - | - | - | 52,5 | - |
| 50 | 28,8 | 46,8* | - | - | - | - | - | - | - | 51,3 | - |
| 54 | 26,0 | 44,7* | - | - | - | - | - | - | - | 50,0 | - |
| 56 | 24,7 | 43,7* | 49,2 | - | - | - | - | - | - | 49,9 | - |
| 58 | 23,5 | 42,7* | 48,8 | - | - | - | - | - | - | 49,1 | - |
| 62 | 21,4 | 40,9* | 47,9 | - | - | - | - | - | - | 47,6 | - |
| 65 | 19,9 | 39,7* | 46,7 | - | - | - | - | - | - | 46,5 | - |
| 66 | 15,9* | 39,3* | 46,4 | - | - | - | - | - | - | 46,2 | - |
| 69 | 14,7* | 38,2* | 45,0 | - | - | - | - | - | - | 44,9 | - |
| 70 | - | - | 44,6 | - | - | - | - | - | - | 44,5 | - |
| 74 | - | - | 42,7 | - | - | - | - | - | - | 42,8 | - |
| 78 | - | - | 40,8 | - | - | - | - | - | - | 41,0 | - |
| 82 | - | - | 38,8 | 38,2 | - | - | - | - | - | 39,1 | - |
| 86 | - | - | 36,7 | 37,3 | - | - | - | - | - | 37,2 | - |
| 90 | - | - | - | 35,9 | - | - | - | - | - | 35,4 | - |
| 94 | - | - | - | 34,2 | - | - | - | - | - | 33,5 | - |
| 98 | - | - | - | 32,3 | - | - | - | - | - | 31,7 | - |
| 102 | - | - | - | 30,3 | - | - | - | - | - | 29,7 | - |
| 103 | - | - | - | 29,8 | - | - | - | - | - | 29,2 | - |
| 106 | - | - | - | - | 26,9 | - | - | - | - | 27,7 | - |
| 110 | - | - | - | - | 25,7 | - | - | - | - | 25,7 | - |
| 114 | - | - | - | - | 24,2 | - | - | - | - | 23,6 | - |
| 118 | - | - | - | - | 22,5 | - | - | - | - | 21,5 | - |
| 119 | - | - | - | - | 22,1 | - | - | - | - | 21,0 | - |
| 122 | - | - | - | - | - | - | - | - | - | 19,5 | - |
| 126 | - | - | - | - | - | - | - | - | - | 17,4 | - |
| 130 | - | - | - | - | - | - | - | - | - | 15,2 | - |
| 134 | - | - | - | - | - | - | - | - | - | 13,1 | - |
| 138 | - | - | - | - | - | - | - | - | - | 11,0 | - |
| 142 | - | - | - | - | - | - | - | - | - | 7,7 | - |
| 146 | - | - | - | - | - | - | - | - | - | 5,0 | - |
| 148 | - | - | - | - | - | - | - | - | - | 4,0 | - |
| 25 | 43,3 | 44,6 | - | - | - | - | - | - | - | - | - |
| 26 | 43,0 | 44,4 | - | - | - | - | - | - | - | - | - |
| 28 | 42,6 | 43,8 | - | - | - | - | - | - | - | - | - |
| 30 | 42,1 | 43,2 | - | - | - | - | - | - | - | - | - |
| 34 | 40,5 | 43,1* | - | - | - | - | - | - | - | - | - |
| 37 | 37,2 | 42,2* | - | - | - | - | - | - | - | 41,8 | - |
| 38 | 36,2 | 42,0* | - | - | - | - | - | - | - | 41,7 | - |
| 42 | 32,0 | 40,7* | - | - | - | - | - | - | - | 41,3 | - |
| 46 | 28,4 | 39,3* | - | - | - | - | - | - | - | 40,8 | - |
| 50 | 25,2 | 37,9* | - | - | - | - | - | - | - | 40,1 | - |
| 54 | 22,5 | 36,4* | - | - | - | - | - | - | - | 39,3 | - |
| 58 | 20,1 | 34,9* | - | - | - | - | - | - | - | 38,3 | - |
| 61 | 18,4 | 33,7* | 36,7 | - | - | - | - | - | - | 37,6 | - |
| 62 | 17,9 | 33,4* | 36,7 | - | - | - | - | - | - | 37,3 | - |
| 66 | 16,0 | 32,0* | 36,3 | - | - | - | - | - | - | 36,3 | - |
| 70 | 14,3 | 30,7* | 35,6 | - | - | - | - | - | - | 35,1 | - |
| 74 | 12,8 | 29,4* | 34,7 | - | - | - | - | - | - | 34,0 | - |
| 77 | 11,8 | 28,5* | 33,7 | - | - | - | - | - | - | 33,1 | - |
| 78 | 8,3* | 28,3* | 33,4 | - | - | - | - | - | - | 32,8 | - |
| 80 | 7,8* | 27,8* | 32,8 | - | - | - | - | - | - | 32,1 | - |
| 82 | - | - | 32,2 | - | - | - | - | - | - | 31,4 | - |
| 86 | - | - | 30,9 | - | - | - | - | - | - | 30,0 | - |
| 89 | - | - | 29,8 | 27,7 | - | - | - | - | - | 29,0 | - |
| 90 | - | - | 29,5 | 27,7 | - | - | - | - | - | 28,7 | - |
| 94 | - | - | 28,1 | 27,2 | - | - | - | - | - | 27,3 | - |
| 98 | - | - | 26,6 | 26,6 | - | - | - | - | - | 25,8 | - |
| 102 | - | - | - | 25,4 | - | - | - | - | - | 24,5 | - |
| 106 | - | - | - | 24,1 | - | - | - | - | - | 23,0 | - |
| 110 | - | - | - | 22,7 | - | - | - | - | - | 21,5 | - |
| 114 | - | - | - | 21,3 | 18,5 | - | - | - | - | 19,8 | - |
| 115 | - | - | - | 20,9 | 18,5 | - | - | - | - | 19,4 | - |
| 118 | - | - | - | - | 18,0 | - | - | - | - | 18,3 | - |
| 122 | - | - | - | - | 17,0 | - | - | - | - | 16,7 | - |
| 126 | - | - | - | - | 15,9 | - | - | - | - | 15,1 | - |
| 130 | - | - | - | - | 14,7 | - | - | - | - | 13,4 | - |
| 134 | - | - | - | - | - | - | - | - | - | 11,6 | - |
| 138 | - | - | - | - | - | - | - | - | - | 9,8 | - |
| 142 | - | - | - | - | - | - | - | - | - | 8,0 | - |
| 146 | - | - | - | - | - | - | - | - | - | 6,3 | - |
| 150 | - | - | - | - | - | - | - | - | - | 4,5 | - |

0 t 65 t 125 t 165 t 205 t 245 t 285 t 325 t

* Main boom angle 85° · Hauptauslegerwinkel 85° · Jarret de flèche principale 85° · Inclinazione braccio base 85° · Ângulo de pluma principal 85° · Ângulo da lança principal 85° · Угол подъема гл. стрелы 85°

Main boom angle 87°, 85°, 75°, 65° and 55°, capacities for intermediate boom positions are calculated by the crane control system IC-1 · Hauptauslegerwinkel 87°, 85°, 75°, 65° und 55°, Traglasten für Zwischenstellungen des Hauptauslegers werden von der Kransteuerung IC-1 berechnet · Jarret de flèche principale 87°, 85°, 75°, 65° et 55°, le système de commande de la grue IC-1 calcule les charges pour les positions intermédiaires de la flèche · Inclinazione braccio base 87°, 85°, 75°, 65° e 55°, capacità per posizioni intermedie del braccio sono calcolate dal sistema di controllo della gru IC-1 · Ângulo de pluma principal 87°, 85°, 75°, 65° y 55°, las capacidades para posiciones de pluma intermedias son calculadas por el sistema de control de grúa IC-1 · Ângulos da lança principal 87°, 85°, 75°, 65° e 55°; as capacidades para posições da lança intermediária são calculadas pelo sistema de controle da grua IC-1 · Грузоподъемность при углах подъема главной стрелы 87°, 85°, 75°, 65° и 55°, грузоподъемность в промежуточных положениях стрелы рассчитывается системой управления краном IC-1

| 165 t + 50 t | | 11-19 m | | 8,40 m | | 9.8 m/s | | 360° | | ISO | |
|--------------|-------|-----------|------|-----------|------|--------------|---|-----------|---|-----------|---|
| 102 m + 84 m | | SWSL_1 | | SFSL_1 | | 108 m + 36 m | | SWSL_1 | | SFSL_1 | |
| 0 t | | 0 t-325 t | | 0 t-325 t | | 0 t | | 0 t-325 t | | 0 t-325 t | |
| 87°/85° | | 87°/85° | | 75° | | 65° | | 55° | | 15° | |
| m | t | t | t | t | t | t | t | t | t | t | t |
| 28 | 32,1 | 33,3 | - | - | - | - | - | - | - | - | - |
| 30 | 31,8 | 32,9 | - | - | - | - | - | - | - | - | - |
| 34 | 31,2 | 32,6* | - | - | - | - | - | - | - | - | - |
| 38 | 30,3 | 32,0* | - | - | - | - | - | - | - | - | - |
| 41 | 28,5 | 31,4* | - | - | - | - | - | - | - | 31,0 | - |
| 42 | 28,0 | 31,2* | - | - | - | - | - | - | - | 30,9 | - |
| 46 | 24,6 | 30,4* | - | - | - | - | - | - | - | 30,5 | - |
| 50 | 21,5 | 29,4* | - | - | - | - | - | - | - | 30,1 | - |
| 54 | 18,9 | 28,4* | - | - | - | - | - | - | - | 29,7 | - |
| 58 | 16,6 | 27,3* | - | - | - | - | - | - | - | 28,9 | - |
| 62 | 14,5 | 26,3* | - | - | - | - | - | - | - | 28,2 | - |
| 66 | 12,7 | 25,3* | 26,3 | - | - | - | - | - | - | 27,6 | - |
| 70 | 11,0 | 24,2* | 26,3 | - | - | - | - | - | - | 26,8 | - |
| 74 | 9,5 | 23,1* | 25,9 | - | - | - | - | - | - | 25,9 | - |
| 78 | 8,1 | 22,1* | 25,4 | - | - | - | - | - | - | 25,0 | - |
| 82 | 6,9 | 21,2* | 24,8 | - | - | - | - | - | - | 24,0 | - |
| 86 | 5,8 | 20,3* | 24,0 | - | - | - | - | - | - | 23,0 | - |
| 89 | 4,7 | 19,7* | 23,4 | - | - | - | - | - | - | 22,2 | - |
| 90 | - | 19,5* | 23,2 | - | - | - | - | - | - | 22,0 | - |
| 92 | - | 19,2* | 22,7 | - | - | - | - | - | - | 21,4 | - |
| 94 | - | - | 22,3 | - | - | - | - | - | - | 20,9 | - |
| 96 | - | - | 21,8 | 18,8 | - | - | - | - | - | 20,4 | - |
| 98 | - | - | 21,4 | 18,8 | - | - | - | - | - | 19,8 | - |
| 102 | - | - | 20,4 | 18,7 | - | - | - | - | - | 18,8 | - |
| 106 | - | - | 19,4 | 18,3 | - | - | - | - | - | 17,7 | - |
| 110 | - | - | 18,3 | 17,5 | - | - | - | - | - | 16,5 | - |
| 114 | - | - | - | 16,7 | - | - | - | - | - | 15,5 | - |
| 118 | - | - | - | 15,8 | - | - | - | - | - | 14,2 | - |
| 122 | - | - | - | 14,8 | - | - | - | - | - | 12,9 | - |
| 123 | - | - | - | 14,5 | 11,4 | - | - | - | - | 12,6 | - |
| 126 | - | - | - | 13,8 | 11,1 | - | - | - | - | 11,7 | - |
| 130 | - | - | - | - | 10,6 | - | - | - | - | 10,4 | - |
| 134 | - | - | - | - | 9,8 | - | - | - | - | 9,1 | - |
| 138 | - | - | - | - | 9,0 | - | - | - | - | 7,8 | - |
| 142 | - | - | - | - | 8,1 | - | - | - | - | 6,5 | - |
| 146 | - | - | - | - | - | - | - | - | - | 5,0 | - |
| 148 | - | - | - | - | - | - | - | - | - | 4,2 | - |
| 18 | 84,5 | 86,5 | - | - | - | - | - | - | - | - | - |
| 20 | 82,5 | 84,5 | - | - | - | - | - | - | - | - | - |
| 22 | 78,5 | 83,0 | - | - | - | - | - | - | - | - | - |
| 24 | 72,5 | 85,5* | - | - | - | - | - | - | - | - | - |
| 26 | 67,5 | 83,5* | - | - | - | - | - | - | - | 82,5 | - |
| 28 | 63,0 | 81,5* | - | - | - | - | - | - | - | 82,0 | - |
| 30 | 59,5 | 79,5* | - | - | - | - | - | - | - | 81,5 | - |
| 34 | 52,5 | 75,5* | - | - | - | - | - | - | - | 80,1 | - |
| 38 | 47,2 | 71,0* | - | - | - | - | - | - | - | 78,6 | - |
| 42 | 42,7 | 67,5* | - | - | - | - | - | - | - | 77,0 | - |
| 46 | 33,7* | 64,5* | - | - | - | - | - | - | - | 74,6 | - |
| 47 | - | - | 74,5 | - | - | - | - | - | - | 74,0 | - |
| 50 | - | - | 72,5 | - | - | - | - | - | - | 72,3 | - |
| 54 | - | - | 69,5 | - | - | - | - | - | - | 69,5 | - |
| 58 | - | - | 65,5 | - | - | - | - | - | - | 66,8 | - |
| 62 | - | - | 61,5 | - | - | - | - | - | - | 64,0 | - |
| 65 | - | - | 58,5 | - | - | - | - | - | - | 61,7 | - |
| 66 | - | - | - | - | - | - | - | - | - | 61,0 | - |
| 70 | - | - | - | - | - | - | - | - | - | 57,6 | - |
| 71 | - | - | - | 54,5 | - | - | - | - | - | 56,8 | - |
| 74 | - | - | - | 52,5 | - | - | - | - | - | 54,5 | - |
| 78 | - | - | - | 49,0 | - | - | - | - | - | 51,5 | - |
| 82 | - | - | - | 45,4 | - | - | - | - | - | 48,3 | - |
| 83 | - | - | - | 44,4 | - | - | - | - | - | 47,5 | - |
| 86 | - | - | - | - | - | - | - | - | - | 45,1 | - |
| 90 | - | - | - | - | - | - | - | - | - | 42,0 | - |
| 93 | - | - | - | - | - | - | - | 37,5 | - | 39,7 | - |
| 94 | - | - | - | - | - | - | - | 36,8 | - | 38,9 | - |
| 98 | - | - | - | - | - | - | - | 34,0 | - | 35,8 | - |
| 99 | - | - | - | - | - | - | - | 33,2 | - | 35,1 | - |
| 102 | - | - | - | - | - | - | - | - | - | 32,8 | - |
| 106 | - | - | - | - | - | - | - | - | - | 29,7 | - |
| 110 | - | - | - | - | - | - | - | - | - | 26,6 | - |
| 114 | - | - | - | - | - | - | - | - | - | 23,6 | - |
| 118 | - | - | - | - | - | - | - | - | - | 20,6 | - |
| 122 | - | - | - | - | - | - | - | - | - | 17,5 | - |
| 126 | - | - | - | - | - | - | - | - | - | 14,3 | - |
| 130 | - | - | - | - | - | - | - | - | - | 10,7 | - |
| 131 | - | - | - | - | - | - | - | - | - | 10,2 | - |

* Main boom angle 85° · Hauptauslegerwinkel 85° · Jarret de flèche principale 85° · Inclinação braccio base 85° · Ángulo de pluma principal 85° · Ângulo da lança principal 85° · Угол подъема гл. стрелы 85°

Main boom angle 87°, 85°, 75°, 65° and 55°, capacities for intermediate boom positions are calculated by the crane control system IC-1 · Hauptauslegerwinkel 87°, 85°, 75°, 65° und 55°, Traglasten für Zwischenstellungen des Hauptauslegers werden von der Kransteuerung IC-1 berechnet · Jarret de flèche principale 87°, 85°, 75°, 65° et 55°, le système de commande de la grue IC-1 calcule les charges pour les positions intermédiaires de la flèche · Inclinação braccio base 87°, 85°, 75°, 65° e 55°, capacità per posizioni intermedie del braccio sono calcolate dal sistema di controllo della gru IC-1 · Ángulo de pluma principal 87°, 85°, 75°, 65° y 55°, las capacidades para posiciones de pluma intermedias son calculadas por el sistema de control de grúa IC-1 · Ângulos da lança principal 87°, 85°, 75°, 65° e 55°; as capacidades para posições da lança intermediária são calculadas pelo sistema de controle da grua IC-1 · Грузоподъемность при углах подъема главной стрелы 87°, 85°, 75°, 65° и 55°, грузоподъемность в промежуточных положениях стрелы рассчитывается системой управления краном IC-1

| 165 t + 50 t | | 11-19 m | | 8,40 m | | 9.8 m/s | | 360° | | ISO | |
|--------------|-------|---------|------|--------|------|---------|--------------|-------|-------|------|------|
| 108 m + 48 m | | | | | | | 108 m + 60 m | | | | |
| SWSL_1 | | | | | | | SWSL_1 | | | | |
| SFSL_1 | | | | | | | SFSL_1 | | | | |
| 0 t | | | | | | | 0 t-325 t | | | | |
| 87°/85° | | | | | | | 87°/85° | | | | |
| 75° | | | | | | | 75° | | | | |
| 65° | | | | | | | 65° | | | | |
| 55° | | | | | | | 55° | | | | |
| 15° | | | | | | | 15° | | | | |
| m | t | t | t | t | t | t | m | t | t | t | t |
| 20 | 65,0 | 67,0 | - | - | - | - | 23 | 50,5 | 52,0 | - | - |
| 22 | 64,5 | 66,0 | - | - | - | - | 24 | 50,0 | 51,5 | - | - |
| 24 | 63,0 | 64,5 | - | - | - | - | 26 | 49,6 | 50,5 | - | - |
| 26 | 61,0 | 66,0* | - | - | - | - | 28 | 48,8 | 50,0 | - | - |
| 28 | 57,5 | 64,5* | - | - | - | - | 30 | 47,7 | 50,5* | - | - |
| 30 | 54,0 | 63,5* | - | - | - | 63,0 | 34 | 43,2 | 49,1* | - | 48,7 |
| 34 | 47,7 | 61,0* | - | - | - | 62,0 | 38 | 38,2 | 47,4* | - | 48,0 |
| 38 | 42,3 | 58,0* | - | - | - | 61,0 | 42 | 34,0 | 45,4* | - | 47,5 |
| 42 | 37,9 | 55,5* | - | - | - | 60,0 | 46 | 30,4 | 43,5* | - | 46,4 |
| 46 | 34,2 | 52,5* | - | - | - | 58,3 | 50 | 27,2 | 41,5* | - | 45,3 |
| 50 | 30,9 | 50,0* | - | - | - | 56,8 | 54 | 24,5 | 39,6* | - | 44,3 |
| 52 | 29,5 | 49,0* | 56,0 | - | - | 56,1 | 57 | 22,7 | 38,2* | 42,8 | 43,3 |
| 54 | 28,2 | 48,0* | 55,5 | - | - | 55,5 | 58 | 22,1 | 37,8* | 42,6 | 43,0 |
| 58 | 21,5* | 46,1* | 53,5 | - | - | 53,1 | 62 | 20,0 | 36,2* | 41,6 | 41,6 |
| 62 | - | - | 51,0 | - | - | 51,1 | 66 | 18,3 | 34,7* | 40,3 | 40,1 |
| 66 | - | - | 48,7 | - | - | 49,3 | 69 | 13,2* | 33,8* | 38,9 | 38,9 |
| 70 | - | - | 46,1 | - | - | 46,9 | 70 | - | - | 38,5 | 38,5 |
| 74 | - | - | 43,4 | - | - | 44,5 | 74 | - | - | 36,8 | 36,8 |
| 76 | - | - | 42,0 | - | - | 43,3 | 78 | - | - | 34,9 | 35,0 |
| 78 | - | - | - | 41,8 | - | 42,1 | 82 | - | - | 33,0 | 33,0 |
| 82 | - | - | - | 39,9 | - | 39,7 | 85 | - | - | 31,6 | 31,6 |
| 86 | - | - | - | 37,6 | - | 37,4 | 86 | - | - | 31,2 | 30,8 |
| 90 | - | - | - | 35,2 | - | 35,0 | 88 | - | - | 30,3 | 30,1 |
| 94 | - | - | - | 32,7 | - | 32,6 | 90 | - | - | - | 29,5 |
| 98 | - | - | - | - | - | 30,2 | 94 | - | - | - | 27,9 |
| 101 | - | - | - | - | 27,8 | 28,4 | 98 | - | - | - | 26,2 |
| 102 | - | - | - | - | 27,4 | 27,8 | 102 | - | - | - | 24,5 |
| 106 | - | - | - | - | 25,5 | 25,4 | 106 | - | - | - | 22,7 |
| 110 | - | - | - | - | 23,5 | 23,1 | 109 | - | - | - | - |
| 111 | - | - | - | - | 23,0 | 22,5 | 110 | - | - | - | 19,4 |
| 114 | - | - | - | - | - | 20,9 | 114 | - | - | - | 19,1 |
| 118 | - | - | - | - | - | 18,3 | 118 | - | - | - | 17,8 |
| 122 | - | - | - | - | - | 15,8 | 122 | - | - | - | 16,4 |
| 126 | - | - | - | - | - | 13,5 | 126 | - | - | - | 15,0 |
| 130 | - | - | - | - | - | 11,1 | 130 | - | - | - | - |
| 134 | - | - | - | - | - | 8,8 | 134 | - | - | - | - |
| 138 | - | - | - | - | - | 6,8 | 138 | - | - | - | - |
| 142 | - | - | - | - | - | 4,8 | 142 | - | - | - | - |
| | | | | | | | 143 | - | - | - | - |
| | | | | | | | | | | | 4,4 |

0 t 65 t 125 t 165 t 205 t 245 t 285 t 325 t

* Main boom angle 85° · Hauptauslegerwinkel 85° · Jarret de flèche principale 85° · Inclinazione braccio base 85° · Ángulo de pluma principal 85° · Ângulo da lança principal 85° · Угол подъема гл. стрелы 85°

Main boom angle 87°, 85°, 75°, 65° and 55°, capacities for intermediate boom positions are calculated by the crane control system IC-1 · Hauptauslegerwinkel 87°, 85°, 75°, 65° und 55°, Traglasten für Zwischenstellungen des Hauptauslegers werden von der Kransteuerung IC-1 berechnet · Jarret de flèche principale 87°, 85°, 75°, 65° et 55°, le système de commande de la grue IC-1 calcule les charges pour les positions intermédiaires de la flèche · Inclinazione braccio base 87°, 85°, 75°, 65° e 55°, capacità per posizioni intermedie del braccio sono calcolate dal sistema di controllo della gru IC-1 · Ángulo de pluma principal 87°, 85°, 75°, 65° y 55°, las capacidades para posiciones de pluma intermedias son calculadas por el sistema de control de grúa IC-1 · Ângulos da lança principal 87°, 85°, 75°, 65° e 55°, as capacidades para posições da lança intermediária são calculadas pelo sistema de controle da grua IC-1 · Грузоподъемность при углах подъема главной стрелы 87°, 85°, 75°, 65° и 55°, грузоподъемность в промежуточных положениях стрелы рассчитывается системой управления краном IC-1

LVSL

15°

CC 3800-1

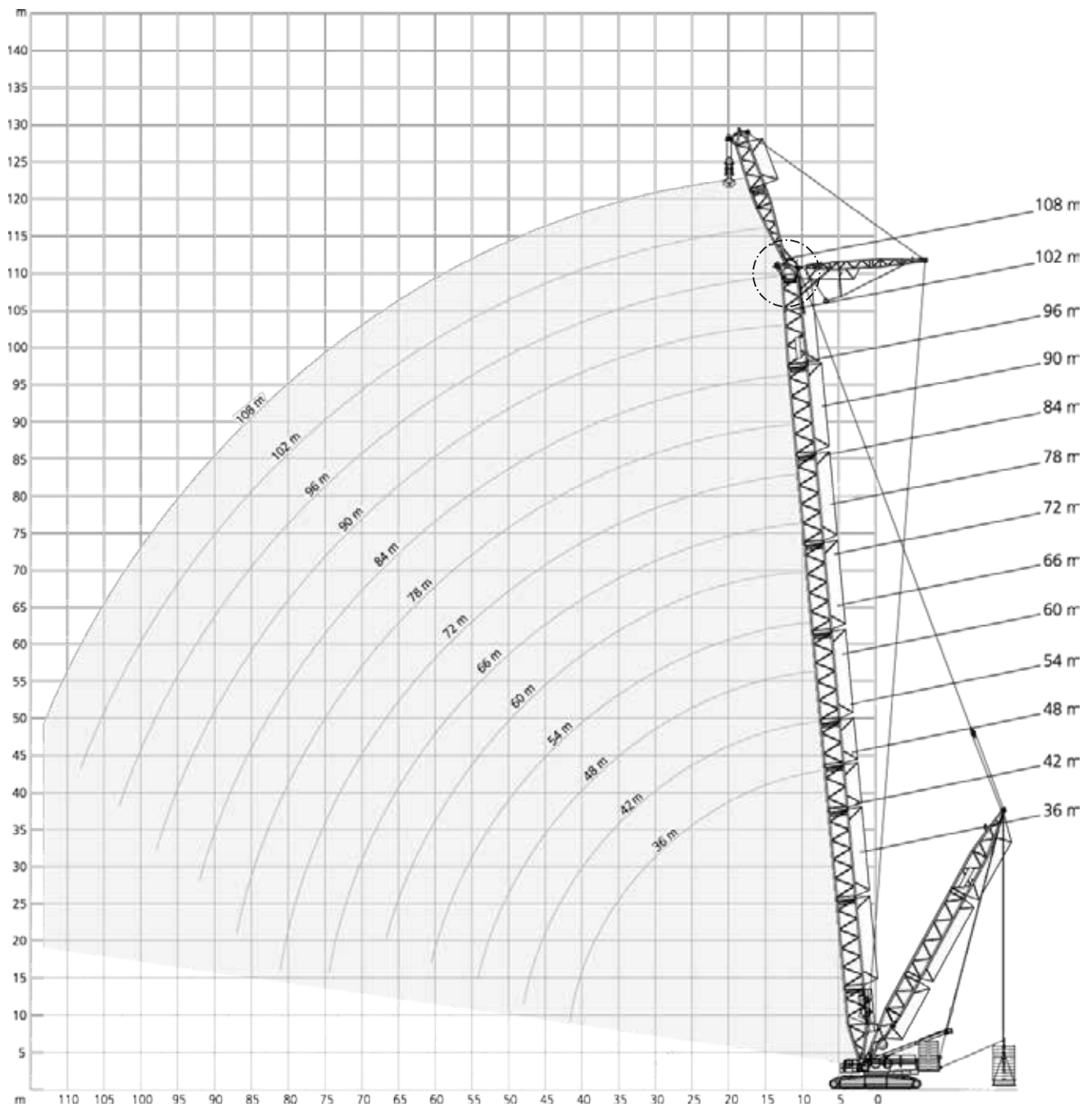
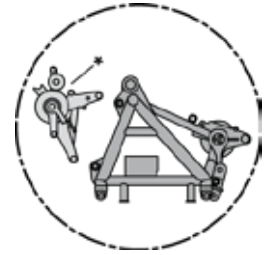

* Attachable · Anbaubar · Amovible · Montabile · Acoplable · Adaptável · Приставн

| LVSL_1 | | | | | | | | | | | | | | | | |
|--------|------|-------|---------|-------|-------|-------|---------|-------|-------|-------|---------|-------|-------|-------|---------|---|
| m | 0t | | 0t-325t | | 0t | | 0t-325t | | 0t | | 0t-325t | | 0t | | 0t-325t | |
| | t | t | t | t | t | t | t | t | t | t | t | t | t | t | t | t |
| 14 | - | - | 199,0 | 347,0 | 190,0 | 347,0 | - | - | - | - | - | - | - | - | - | - |
| 15 | - | - | 184,0 | 347,0 | 176,0 | 347,0 | 169,0 | 347,0 | 162,0 | 334,0 | - | - | - | - | - | - |
| 16 | - | - | 171,0 | 347,0 | 164,0 | 347,0 | 157,0 | 347,0 | 151,0 | 334,0 | 145,0 | 294,0 | 139,0 | 262,0 | - | - |
| 18 | - | - | 149,0 | 347,0 | 143,0 | 347,0 | 138,0 | 347,0 | 132,0 | 333,0 | 127,0 | 294,0 | 122,0 | 262,0 | - | - |
| 20 | - | - | 132,0 | 347,0 | 126,0 | 347,0 | 121,0 | 347,0 | 116,0 | 327,0 | 112,0 | 294,0 | 107,0 | 262,0 | - | - |
| 22 | - | - | 116,0 | 347,0 | 112,0 | 347,0 | 108,0 | 347,0 | 103,0 | 323,0 | 100,0 | 290,0 | 95,5 | 262,0 | - | - |
| 24 | - | - | 101,0 | 347,0 | 100,0 | 344,0 | 97,0 | 342,0 | 92,5 | 320,0 | 89,5 | 287,0 | 85,0 | 259,0 | - | - |
| 25 | 96,5 | 335,0 | 95,2 | 333,5 | 94,0 | 331,0 | 91,7 | 329,0 | 88,0 | 317,0 | 84,7 | 284,0 | 80,7 | 256,0 | - | - |
| 26 | 90,5 | 322,0 | 89,5 | 320,0 | 88,0 | 318,0 | 86,5 | 316,0 | 83,5 | 314,0 | 80,0 | 284,0 | 76,5 | 256,0 | - | - |
| 28 | 81,0 | 298,0 | 79,5 | 296,0 | 78,0 | 293,0 | 76,5 | 291,0 | 75,0 | 290,0 | 72,0 | 281,0 | 68,5 | 254,0 | - | - |
| 30 | 72,5 | 276,0 | 71,0 | 274,0 | 69,5 | 272,0 | 68,0 | 270,0 | 66,5 | 268,0 | 65,0 | 267,0 | 62,0 | 251,0 | - | - |
| 34 | 59,8 | 236,0 | 58,3 | 240,6 | 56,8 | 238,6 | 55,4 | 236,6 | 54,0 | 234,6 | 53,0 | 233,6 | 51,0 | 227,0 | - | - |
| 38 | 49,4 | 199,3 | 47,8 | 211,0 | 46,1 | 209,3 | 44,5 | 207,6 | 43,1 | 205,6 | 42,3 | 204,6 | 40,9 | 203,0 | - | - |
| 42 | 41,2 | 166,0 | 39,5 | 185,0 | 37,4 | 184,0 | 35,5 | 183,0 | 33,9 | 181,0 | 32,9 | 180,0 | 31,5 | 179,0 | - | - |
| 46 | 34,9 | 140,0 | 32,9 | 158,3 | 30,8 | 164,6 | 28,9 | 163,0 | 27,1 | 161,6 | 26,1 | 160,6 | 24,7 | 159,6 | - | - |
| 50 | 29,2 | 114,3 | 27,3 | 135,3 | 25,1 | 145,6 | 23,1 | 145,6 | 21,3 | 144,3 | 20,2 | 143,3 | 18,7 | 142,3 | - | - |
| 51 | 27,9 | 108,0 | 26,1 | 130,5 | 23,9 | 141,0 | 21,9 | 142,0 | 20,0 | 140,5 | 19,0 | 139,5 | 17,4 | 138,5 | - | - |
| 54 | - | - | 22,5 | 116,0 | 20,2 | 127,0 | 18,2 | 131,0 | 16,3 | 129,0 | 15,2 | 128,0 | 13,6 | 127,0 | - | - |
| 56 | - | - | 20,5 | 109,0 | 18,3 | 117,6 | 16,3 | 124,3 | 14,3 | 123,3 | 13,2 | 122,3 | 11,6 | 121,0 | - | - |
| 58 | - | - | - | - | 16,4 | 109,6 | 14,4 | 117,6 | 12,4 | 117,6 | 11,2 | 116,6 | 9,6 | 115,0 | - | - |
| 61 | - | - | - | - | 13,8 | 99,0 | 11,7 | 107,0 | 9,7 | 109,2 | 8,5 | 108,6 | 6,7 | 106,7 | - | - |
| 62 | - | - | - | - | - | - | 11,0 | 103,0 | 8,9 | 106,5 | 7,7 | 106,3 | 5,9 | 104,5 | - | - |
| 64 | - | - | - | - | - | - | 9,5 | 95,6 | 7,4 | 101,0 | 6,1 | 101,6 | 4,3 | 100,0 | - | - |
| 66 | - | - | - | - | - | - | 8,0 | 91,0 | 5,9 | 95,5 | 4,6 | 97,0 | - | 95,5 | - | - |
| 68 | - | - | - | - | - | - | - | - | 4,6 | 88,5 | - | 92,5 | - | 91,6 | - | - |
| 70 | - | - | - | - | - | - | - | - | - | 82,8 | - | 88,0 | - | 87,8 | - | - |
| 71 | - | - | - | - | - | - | - | - | - | 81,0 | - | 85,7 | - | 85,9 | - | - |
| 74 | - | - | - | - | - | - | - | - | - | - | - | 77,5 | - | 80,0 | - | - |
| 77 | - | - | - | - | - | - | - | - | - | - | - | 70,5 | - | 74,0 | - | - |
| 78 | - | - | - | - | - | - | - | - | - | - | - | - | - | 72,0 | - | - |
| 82 | - | - | - | - | - | - | - | - | - | - | - | - | - | 62,5 | - | - |

| | | | | | | | |
|--|----|------|------|------|------|------|------|
| | 0t | 125t | 165t | 205t | 245t | 285t | 325t |
|--|----|------|------|------|------|------|------|

| LVSL_1 | | | | | | | | | | | | |
|--------|-------|-------|---------|-------|-------|-------|---------|-------|------|-------|---------|-------|
| | | | | | | | | | | | | |
| | 0t | | 0t-325t | | 0t | | 0t-325t | | 0t | | 0t-325t | |
| m | t | t | t | t | t | t | t | t | t | t | t | t |
| 17 | 125,0 | 217,0 | 120,0 | 196,0 | - | - | - | - | - | - | - | - |
| 18 | 117,0 | 217,0 | 112,0 | 196,0 | 108,0 | 175,0 | 103,0 | 157,0 | - | - | - | - |
| 19 | 110,0 | 217,0 | 105,0 | 195,0 | 101,0 | 175,0 | 96,5 | 157,0 | 92,5 | 140,0 | 88,0 | 125,0 |
| 20 | 104,0 | 217,0 | 99,5 | 195,0 | 95,0 | 175,0 | 90,5 | 157,0 | 86,5 | 140,0 | 82,5 | 125,0 |
| 22 | 92,0 | 216,0 | 88,0 | 194,0 | 84,0 | 173,0 | 80,0 | 156,0 | 76,5 | 139,0 | 72,5 | 124,0 |
| 24 | 82,0 | 214,0 | 78,5 | 192,0 | 75,0 | 172,0 | 71,0 | 155,0 | 67,5 | 138,0 | 64,0 | 123,0 |
| 26 | 73,5 | 212,0 | 70,0 | 190,0 | 66,5 | 170,0 | 63,0 | 153,0 | 60,0 | 137,0 | 56,5 | 122,0 |
| 28 | 66,0 | 210,0 | 62,5 | 188,0 | 59,5 | 168,0 | 56,0 | 151,0 | 53,0 | 134,0 | 50,0 | 120,0 |
| 30 | 59,5 | 208,0 | 56,0 | 186,0 | 53,0 | 166,0 | 50,0 | 149,0 | 47,2 | 132,0 | 44,1 | 118,0 |
| 34 | 49,1 | 201,3 | 45,9 | 180,0 | 43,1 | 161,3 | 40,2 | 144,3 | 37,4 | 128,6 | 34,5 | 114,6 |
| 38 | 39,6 | 190,6 | 37,0 | 173,0 | 34,4 | 156,0 | 31,6 | 139,3 | 28,9 | 124,3 | 26,2 | 110,6 |
| 42 | 31,0 | 178,0 | 29,4 | 167,0 | 27,0 | 150,0 | 24,2 | 134,0 | 21,7 | 119,0 | 19,0 | 106,0 |
| 46 | 24,1 | 158,6 | 22,6 | 154,3 | 21,1 | 143,3 | 18,4 | 128,0 | 16,1 | 113,6 | 13,4 | 101,3 |
| 50 | 18,1 | 141,6 | 16,7 | 140,3 | 15,6 | 134,6 | 13,3 | 122,3 | 11,0 | 108,3 | 8,4 | 96,6 |
| 53 | 14,2 | 130,6 | 12,8 | 128,8 | 11,7 | 126,6 | 9,9 | 118,3 | 7,6 | 104,3 | 5,0 | 93,0 |
| 54 | 13,0 | 127,0 | 11,5 | 125,0 | 10,4 | 124,0 | 8,8 | 117,0 | 6,5 | 103,0 | - | 92,0 |
| 56 | 10,9 | 121,0 | 9,4 | 119,3 | 8,3 | 118,3 | 6,6 | 114,0 | 4,5 | 101,0 | - | 89,5 |
| 58 | 8,9 | 115,0 | 7,4 | 113,6 | 6,2 | 112,6 | 4,5 | 111,0 | - | 98,2 | - | 87,0 |
| 60 | 6,9 | 109,0 | 5,4 | 108,0 | 4,2 | 107,0 | - | 105,0 | - | 95,5 | - | 84,5 |
| 61 | 6,0 | 106,3 | 4,5 | 105,0 | - | 104,5 | - | 102,6 | - | 94,1 | - | 83,2 |
| 62 | 5,2 | 103,6 | - | 102,7 | - | 102,1 | - | 100,3 | - | 92,8 | - | 82,0 |
| 63 | 4,4 | 101,0 | - | 100,4 | - | 99,7 | - | 98,0 | - | 91,5 | - | 80,7 |
| 66 | - | 95,0 | - | 93,5 | - | 92,5 | - | 91,0 | - | 87,5 | - | 77,0 |
| 70 | - | 87,3 | - | 85,8 | - | 84,8 | - | 83,3 | - | 81,1 | - | 72,0 |
| 74 | - | 80,1 | - | 78,6 | - | 77,6 | - | 76,1 | - | 74,6 | - | 67,2 |
| 78 | - | 73,5 | - | 72,0 | - | 71,0 | - | 69,5 | - | 68,0 | - | 62,5 |
| 82 | - | 66,5 | - | 66,6 | - | 65,4 | - | 63,6 | - | 62,3 | - | 58,1 |
| 86 | - | 58,3 | - | 61,5 | - | 60,0 | - | 58,5 | - | 57,0 | - | 53,8 |
| 87 | - | 56,0 | - | 59,5 | - | 58,7 | - | 57,2 | - | 55,7 | - | 52,7 |
| 90 | - | - | - | 53,5 | - | 55,0 | - | 53,5 | - | 52,0 | - | 49,5 |
| 92 | - | - | - | 49,5 | - | 51,7 | - | 51,1 | - | 49,8 | - | 47,3 |
| 94 | - | - | - | - | - | 48,5 | - | 48,8 | - | 47,6 | - | 45,2 |
| 98 | - | - | - | - | - | 41,6 | - | 43,2 | - | 43,4 | - | 41,0 |
| 102 | - | - | - | - | - | - | - | 36,8 | - | 38,3 | - | 37,0 |
| 103 | - | - | - | - | - | - | - | 35,2 | - | 36,8 | - | 35,9 |
| 106 | - | - | - | - | - | - | - | - | - | 32,4 | - | 32,6 |
| 108 | - | - | - | - | - | - | - | - | - | 29,5 | - | 30,5 |
| 110 | - | - | - | - | - | - | - | - | - | - | - | 27,8 |
| 113 | - | - | - | - | - | - | - | - | - | - | - | 23,9 |

| | | | | | | | |
|--|----|------|------|------|------|------|------|
| | 0t | 125t | 165t | 205t | 245t | 285t | 325t |
|--|----|------|------|------|------|------|------|

Anmerkungen zu den Tragfähigkeiten · Conditions d'utilisation · Annotazioni sulle portate · Condiciones de utilización · Notas sobre capacidade de içamento · Примечания по грузоподъемности

Ratings are in compliance with EN 13000/ISO 4305 and ASME B 30.5.
Weight of hook blocks and slings is part of the load, and is to be deducted from the capacity ratings.
Consult operation manual for further details.

Note: Data published herein is intended as a guide only and shall not be construed to warrant applicability for lifting purposes.
Crane operation is subject to the computer charts and operation manual both supplied with the crane.
In some instances the superlift counterweight does not lift off the ground with the indicated load.

Tragfähigkeiten entsprechen EN 13000/ISO 4305 und ASME B 30.5.
Das Gewicht der Unterflaschen, sowie die Lastaufnahmemittel, sind Bestandteile der Last und sind von den Tragfähigkeitsangaben abzuziehen.
Weitere Angaben in der Bedienungsanleitung des Kranes.

Anmerkung: Die Daten dieser Broschüre dienen nur zur allgemeinen Information; für ihre Richtigkeit übernehmen wir keine Haftung.
Der Betrieb des Kranes ist nur mit den Original-Tragfähigkeitstabellen und mit der Bedienungsanleitung zulässig, die mit dem Kran mitgeliefert werden.

In einigen Fällen hebt das Superliftgegengewicht bei den angegebenen Traglasten nicht ab.

Le tableau de charges est conforme à la norme EN 13000/ISO 4305 et ASME B 30.5.
Les poids du crochet-moufle et de tous les accessoires d'élingage font partie de la charge et sont à déduire des charges indiquées.
Pour plus de détails consulter la notice d'utilisation de la grue.

Nota : Les renseignements ci-inclus sont donnés à titre indicatif et ne représentent aucune garantie d'utilisation pour les opérations de levage. La mise en service de la grue n'est autorisée qu'à condition que les tableaux de charges ainsi que le manuel de service, tels que fournis avec la grue, soient observés.

Le contrepoids du superlift ne décolle pas dans certaines configurations des tableaux de charge.

Le portate sono conformi alla norma EN 13000/ISO 4305 e ASME B 30.5.
Il peso del bozzello e delle funi d'attacco fanno parte del carico e sono quindi da detrarre dai valori di tabella.
Per ulteriori dettagli sulla velocità vento, consultare il manuale di istruzione della gru.

Nota: I dati riportati su tale prospetto sono solo a titolo indicativo e pertanto non impegnativi. L'impiego della gru è ammesso solo rispettando le tabelle originali ed il manuale di uso fornito assieme alla gru.

In alcuni casi, con il carico indicato, il contrappeso Superlift non si solleva dal suolo.

Las capacidades de carga están sujetas a las normas EN 13000/ISO 4305 y ASME B 30.5.
El peso de los ganchos y eslingas son parte de la carga y serán deducidos de las capacidades brutas.
Consultar los manuales de operación para ampliar información.

Observación: Los datos publicados son solamente orientativos y no se deben interpretar como garantía de aplicación para determinadas operaciones de elevación. La manipulación de la grúa está sujeta a las cargas programadas en el ordenador y en el manual de operaciones, ambos suministrados con la grúa.

En algunos casos, el contrapeso superlift no se eleva del suelo con la carga indicada.

Valores nominais de acordo com a EN 13000/ISO 4305 e ASME B 30.5.
O peso dos moitões e eslingas faz parte da carga e tem de ser subtraído das capacidades nominais.
Consultar manual de operação para outros detalhes.

Nota: Os dados publicados aqui destinam-se a simples orientação e não devem ser interpretados como garantia de aplicabilidade para fins de içamento. A operação da grua depende de tabelas de computador e do manual de operação, ambos fornecidos com a máquina.

Em alguns casos, o contrapeso do Superlift não levanta do solo com a carga indicada.

Номинальные значения соответствуют EN 13000/ISO 4305 и ASME B 30.5.
Вес крюкоблока и строп является частью груза и должен вычитаться из номинальных значений грузоподъемности.
Подробности см. в руководстве по эксплуатации.

Примечание. Публикуемые в настоящем издании данные приводятся только для справки и не должны использоваться при расчете нагрузки. При эксплуатации крана должны применяться компьютерные таблицы и руководство по эксплуатации, входящие в комплект поставки крана.

В некоторых случаях противовес системы суперлифт не может быть поднят с земли с указанной нагрузкой.

Crawler carrier

3-section carrier comprising of carbody and two crawlers. Hydraulic pin connections between crawlers and carbody provide for easy assembly and removal to minimise width and weight for transportation. Track width: 8.40 m.

Carbody

Bending- and torsion-resistant welded structure of box type construction, fabricated of high-strength fine grain structural steel.

Crawlers

Bending-resistant welded structure of high-strength fine grain structural steel. Automatic centralised lubrication is included as standard. 16 rollers on each side frame with hardened rolling surfaces. Raised position for both drive sprockets and idler wheels, drive sprockets and idler wheels provide load bearing capacity for erection, adjustable track tension. Crawler pads: 1.50 m wide.

Crawler drive

The tracks are powered by one hydraulic motor each through closed planetary gear reduction units running in oil bath, equipped with spring-applied hydraulically released holding brakes; the gear units are of very compact design to fit within the width of the crawlers. Each crawler is infinitely variable controlled, both independently and in opposite direction. Tractive effort: 1,400 kN per side.

Assembly jacks

Four hydraulic jacking cylinders on carbody (folding within 3 m width) for easy assembly of crawlers.

Superstructure

Counterweight

205 t (max. 225 t) counterweight on superstructure combination with 50 t central ballast. Steelbox type. Weight of counterweight blocks: 10 t.

Total weight

Approx. 390 t, incl. 165 t counterweight, 24 m SH_1 boom and hook block.

Travel speed on crawlers

Max. 1,1 km/h.

Reeving winch

Mounted on superstructure.

Frame

Torsion-resistant welded structure fabricated of high-strength fine grain structural steel.

Slew ring

Triple-row roller bearing slew ring with external ring gear for ease of service and maintenance. Central lubrication system.

Drive

Pump distribution gearbox with five variable displacement axial piston pumps, and gear pumps. Silencer with spark-arrestor. Sound insulation covering. 6 cylinder Mercedes-Benz diesel engine type OM 471 LA. Output: 390 kW (523 HP) at 1700 1/min, torque 2460 Nm at 1300 1/min each. The engine complies with emission standard EU Stage IV / EPA Tier 4f regulations. The system is equipped with Ad-Blue and a SCR catalytic converter.

Optional for non-regulated markets: 8 cylinder Mercedes-Benz diesel engine type OM 502 LA. Output: 405 kW (543 HP) at 1800 1/min, torque 2600 Nm at 1300 1/min each. The engine complies with emission standard EU Stage III A / EPA Tier 3 regulations. Fuel tank capacity: 1217 l.

Rope drums

The standard superstructure equipment includes three rope drums – hoist 1, 2 and boom hoist. The drums are powered by hydraulic motors through closed planetary gear units running in oil bath. All rope drums have spring-applied, hydraulically released multi-disk brakes and non-wearing hydraulic braking for load lowering. Rope ends H 1, 2, 3 and W 1, 2 equipped with quick-connect rope end-fittings. All winches are removable to minimise weight for transportation.

A-frame

Hydraulic raising systems for A-frame as standard. A-frame, boom hoist and sheave sets for boom hoist can be dismantled as one single transport unit to minimise transport weight. Dismantling of hoist 1 and 2 possible without removing A-frame first.

Slew unit

Powered by hydraulic motors through 2 closed, planetary gear units running in oil bath. Spring-applied, hydraulically released holding brakes and non-wearing hydraulic braking. Slew speed infinitely variable 0-1 rpm.

Control system

IC-1: Electronic proportional valve pilot control integrated in stored-program control system incl. diagnostic system. Two monitors with colour displays, load moment indicator operated via a touch screen. Working speeds infinitely variable controlled by the lever position. Automatic power control for optimal utilisation of engine output; emergency control systems.

Additional functions:

- Infinitely variable position of Superlift counterweight with the optional adjustable Superlift system 11-19 m
- Infinitely variable position of main boom angle in SWSL configuration 55-87° (65-87° in SW configuration)
- Working area limitation
- Diagnosis and troubleshooting
- User defined joystick mode

The crane is controlled by joystick levers ergonomically positioned in the crane cab. Wireless rigging remote control. Wireless emergency remote control.

Cab

Comfortable cab with large windscreen and air condition. Shatterproof-glazing all around, roof window, self-contained hot air heater, full instrumentation and crane controls. Infinitely adjustable operator seat, emergency seat, multiple storage areas, 12-V power plug. The cab can be tilted back for improved operator view of boom point. A camera system is installed to monitor the rope drums. Front window can be opened. Dashboard can be adjusted for optimum ergonomics and view. Front wiper with resting position outside of window area for optimum view. For transportation, the cab swings hydraulically in front of the superstructure to minimise width.

Electrical equipment

24 V DC. system (2 x batteries 12 V, 200 Ah).

Operator aids

Load moment indicator integrated in IC-1 control (load moment, radius, angles, engine and hydraulic system monitoring), hoist limit switch, limit switches for boom movements, hydraulic boom backstop, position light, anemometer.

Boom Combinations

See page 14-21.

Optional equipment

Hydraulic quick connection

| | |
|---------------------|--|
| Crawler pads | 2.0 m. |
| Quadro drive | 2 drives for each crawler carrier 2600 kN tractive force – at reduced drive speed. |

Alternative counterweights made of cast iron

Alternative counterweight segmentation 10 t + 7.5 t or 10 t + 15 t

| | |
|--------------------------------------|---------------------------------------|
| Hydraulic cylinder on A-frame | For self-assembly of crawler carrier. |
|--------------------------------------|---------------------------------------|

| | |
|--|-------------------|
| Hydraulic cylinder with or without hydraulic unit | For boom pinning. |
|--|-------------------|

| | |
|--|------------------------------------|
| Additional lateral outrigger system | For erection of long boom systems. |
|--|------------------------------------|

| | |
|-------------------------|---|
| Boom Booster Kit | Consists of 2 x 12 m adapter sections and up to 7 x 12 m inserts. Available in length 24 m, 48 m, 60 m, 84 m, 108 m. Extension of Superlift mast from 36 m to 39.5 m or 42 m. |
|-------------------------|---|

| | |
|-------------------|---|
| Flex frame | Infinite positioning of Superlift counterweight from 13-21 m. |
|-------------------|---|

| | |
|-------------------|---|
| Split tray | Superlift tray frame with removable platform underneath the center stack of counterweights (center stack max. 125 t). |
|-------------------|---|

| | |
|--------------------|--|
| Standard SL | 36 m Superlift mast incl. hoist W2. SL pendant bars, mast back stop cylinders, SL tray. Superlift counterweight 0 t at radius 9 m or 0-325 t on counterweight tray at fixed radii 11 m, 13 m, 15 m, 17 m and 19 m. |
|--------------------|--|

| | |
|--------------------|--|
| Variable SL | Variable 36 m Superlift mast (see Standard SL). Additional vertical hydraulic cylinders and stabilisation winch on superstructure (prevents weaving of counterweight especially when traveling and slewing). Height compensation using the cylinders, lifting across obstacles possible to a certain extent. Superlift counterweight 0 t at radius 9 m or 0-325 t on counterweight tray, indefinitely variable from 11-19 m. |
|--------------------|--|

| | |
|---------------------------------|--|
| SL counterweight carrier | Superlift mast (see Standard SL). Telescopic frame and counterweight carrier for total weight of 325 t, with 4 wheels / 2 axles (driven and steered – full manoeuvrability for slewing, trailing, and parallel modes). Superlift counterweight 40-325 t on counterweight carrier with fixed mast radius approx. 16 m; infinitely adjustable from 13-17 m or 17-19 m resp. with telescopic frame. The counterweight carrier allows for traveling or slewing even when the Superlift counterweight does not lift off the ground (e.g. crane with loads as indicated by load chart values in brackets). |
|---------------------------------|--|

| | |
|-----------------|---|
| Hoist H3 | Additional hoist for main boom (to operate LF or runner), line pull same as H1, length 650 m. |
|-----------------|---|

| | |
|---------------|---|
| Runner | Max. lifting capacity 54 t. Mounted on boom head and boom / jib top. Operation by hoist rope 3 (see variable SL). |
|---------------|---|

| | |
|-------------------------------|---|
| Runner for LF standard | Max. lifting capacity 18 t. Operated by rope 3. |
|-------------------------------|---|

| | |
|--------------------------------|---|
| Special LF linkage head | Without sheave set for higher lifting capacities when using LF. |
|--------------------------------|---|

| | |
|---------------------------------|-------------------------------|
| 3 m intermediate section | For 3 m-intermediate lengths. |
|---------------------------------|-------------------------------|

Raupenunterwagen

3-teiliger Raupenunterwagen bestehend aus Mittelstück und zwei Raupenträgern. Mittelstück und Raupen werden hydraulisch verbolzt und sind einfach demontierbar zum Erreichen günstiger Transportabmessungen und Gewichte. Spurbreite: 8,40 m.

Mittelstück

Biege- und verwindungssteife Kastenprofil-Schweißkonstruktion aus hochfestem Feinkornbaustahl.

Raupen

Biegesteife Schweißkonstruktion aus hochfestem Feinkornbaustahl. Automatische Zentralschmieranlage serienmäßig. 16 Laufrollen pro Seitenrahmen mit gehärteten Laufflächen. Erhöhte Lagerung von Turas und Leitrad, für Aufrichten als erweiterbare Basis nutzbar, einstellbare Kettenspannung. Bodenplatten: 1,50 m breit.

Raupenantrieb

Die Raupen werden von je einem Hydromotoren über geschlossene, ölbadgeschmierte Planetengetriebe mit federbelasteten, hydraulisch gelösten Haltebremsen angetrieben; die Antriebseinheiten sind sehr kompakt konzipiert, um die Breite der Raupen nicht zu überschreiten. Die Raupen können unabhängig voneinander, auch gegenläufig, stufenlos geregelt werden. Antriebskraft: 1400 kN pro Seite.

Montageabstützung

Vier hydraulische Stützzyylinder am Mittelstück (innerhalb 3 m Transportbreite anklappbar) zur einfachen Montage der Raupen.

Oberwagen

Gegengewicht

205 t (max. 225 t) auf Oberwagen in Verbindung mit 50 t Zentralballast. Stahlkastenausführung. Gewicht der Blöcke 10 t.

Gesamtgewicht

Ca. 390 t, einschl. 165 t Gegengewicht, 24 m SH_1 Hauptausleger und Unterflasche.

Fahrgeschwindigkeit auf Ketten

Max. 1,1 km/h.

Einscherwinde

Auf Oberwagen angebaut.

Rahmen

Verformungssteife Schweißkonstruktion aus hochfestem Feinkornbaustahl.

Drehkranz

3-reihige Rollendrehverbindung mit Außenzahnkranz für einfache Wartung. Zentralschmierung.

Antrieb

Pumpenverteilergetriebe mit fünf verstellbaren Axialkolbenpumpen und zusätzlichen Zahnraddumpen. Schalldämpfer mit Funkenfänger. Schalldämm-Abdeckung. 6-Zylinder Mercedes-Benz Dieselmotor Typ OM 471 LA. Leistung: jeweils 390 kW (523 PS) bei 1700 1/min, Drehmoment 2460 Nm bei 1300 1/min. Der Motor entspricht der Emissionsnorm EU Stage IV / EPA Tier 4f. Das System arbeitet mit Ad-Blue und einem SCR-Katalysator.

Optional für nicht-regulierte Märkte: 8-Zylinder Mercedes-Benz Dieselmotor Typ OM 502 LA. Leistung: Jeweils 405 kW (543 PS) bei 1800 1/min, Drehmoment 2600 Nm bei 1300 1/min. Der Motor entspricht der Emissionsnorm EU Stage III A / EPA Tier 3. Kraftstoffbehälter: 1217 l.

Seilwinden

Der Oberwagen ist serienmäßig mit drei Seilwinden – Hubwerk 1, Hubwerk 2 und Einziehwerk – ausgerüstet. Der Antrieb der Winden erfolgt durch Hydromotoren mit geschlossenen, ölbadgeschmierten Planetengetrieben. Alle Seilwinden sind mit federbelasteten, hydraulisch freigegebenen Lamellenbremsen und verschleißfreier, hydraulischer Bremsung für die Lastabsenkung ausgestattet. Die Seilenden der Winden H 1, 2, 3 und W 1, 2 sind mit Pressfitting und Taschen ausgestattet. Alle Winden sind zur Minimierung des Transportgewichtes demontierbar.

A-Bock

Hydraulische A-Bock-Umlage serienmäßig. A-Bock zur Minimierung des Transportgewichtes gemeinsam mit Einziehwerk und Rollensätzen als komplette Transporteinheit demontierbar. Hubwerk 1 und 2 können ohne vorherige Demontage des A-Bocks demontiert werden.

Drehwerk

Antrieb durch Hydromotoren über 2 geschlossene, ölbadgeschmierte Planetengetriebe. Federbelastete, hydraulisch freigegebene Haltebremse und verschleißfreie hydraulische Bremsung. Drehgeschwindigkeit stufenlos einstellbar von 0-1 1/min.

Steuerung

IC-1: Elektronische Proportionalventilvorsteuerung integriert in speicherprogrammierte Steuerung mit Fehlerdiagnose. Zwei Farbbildschirme, Lastanzeige, Bedienung über Touchscreen. Stufenlos über Hebelposition regelbare Arbeitsgeschwindigkeiten. Antriebs-Leistungsregelung für optimale Nutzung der Motorleistung; Notsteuerung.

Zusatzfunktionen:

- Stufenlos einstellbare Position des Superlift-Gegengewichts mit dem Superlift-Verstellungssystem 11-19 m (optional)
- Hauptauslegerwinkel in SWSL-Konfiguration stufenlos von 55-87° verstellbar (SW: 65-87°)
- Arbeitsbereichsbegrenzung
- Diagnose und Fehlersuche
- Nutzerdefinierter Joystickmodus

Kransteuerung durch ergonomisch angeordnete Joysticks. Funkfernsteuerung zum Rüsten. Not-Funkfernsteuerung.

Kabine

Komfortkabine mit großzügig dimensionierter Frontscheibe und Klimaanlage. Sicherheitsverglasung rundum, Dachfenster, motorunabhängige Warmluftheizung, Steuer- und Kontrollelemente für die Kranfunktionen. Stufenlos einstellbarer Fahrersitz, Notsitz, vielfältige Ablagemöglichkeiten, 12 V-Steckdose. Die Kabine ist zur Sichtverbesserung nach hinten neigbar. Zur Überwachung der Winden ist ein Kamerasystem installiert. Frontfenster kann geöffnet werden. Armaturenbrett für beste Sicht und Ergonomie einstellbar. Front-Wischerruhestellung außerhalb des Fensters für optimale Sicht. Während des Transportes ist die Kabine zur Minimierung der Gesamtbreite vor den Oberwagen hydraulisch geschwenkt.

Elektrische Anlage

Betriebsspannung 24 V (2 Batterien 12 V / 200 Ah).

Sicherheitseinrichtungen

Lastmomentbegrenzer in IC-1 integriert (Lastmoment, Ausladung, Winkel, Motor- und Hydrauliküberwachung) Hubendschalter, Endschalter für Auslegerbewegungen, hydraulische Ausleger-Rückfallsicherungen, Positionsleuchte, Windmesser.

Ausleger-Kombinationen

Siehe Seite 14-21.

Zusatzausrüstung

Hydraulische Schnell- verbindung

Bodenplatten 2,0 m.

Quadro-Antrieb 2 Antriebe pro Raupenträger: Vortriebskraft 2600 kN – bei reduzierter Fahrgeschwindigkeit.

Alternative Gegengewichte aus Guß

**Alternative Gegengewichts-
stückelung**
10 t + 7,5 t oder 10 t + 15 t

**Hydraulikzylinder am
A-Bock** Für Raupenträgerselbstmontage.

**Hydraulikzylinder ohne
oder mit Hydraulikaggregat** Für Auslegerverbolzung.

Zusatzabstützung seitlich Zum Aufrichten langer Auslegersysteme.

Boom Booster Kit Besteht aus 2 x 12 m Adaptersegmenten und bis zu 7 x 12 m Einsätzen.
Verfügbare Längen: 24 m, 48 m, 60 m, 84 m, 108 m.
Verlängerung des Superlift-Masts von 36 m auf 39,5 m oder 42 m.

Flex frame Stufenlose Positionierung des Superlift-Gegengewichts von 13 m bis 21 m.

Split tray Superlift-Traversenrahmen mit demontierbarer Plattform unterhalb des mittigen Gegengewichtstapels (mittiger Stapel max. 125 t).

Standard SL 36 m Superlift-Mast inkl. Winde W2.
SL Abspannstangen, Mast-Rückfallzylinder, SL-Traverse.
Superlift-Gegengewicht 0 t auf Radius 9 m oder 0-325 t auf Gegengewichts-Traverse mit fest eingestellten 11 m, 13 m, 15 m, 17 m, 19 m.

Variabler SL 36 m Superlift-Mast (siehe Standard SL).
Zusätzliche, vertikale Hydraulikzylinder und Stabilisierungswinde auf dem Oberwagen (verhindert Pendeln des Gegengewichts, insbesondere beim Verfahren und Schwenken). Höhenausgleich mittels Zylinder, Hub über Störkanten / Hindernisse hinweg in bestimmten Grenzen möglich. Superlift-Gegengewicht 0 t auf Radius 9 m oder 0-325 t auf Gegengewicht-Traverse einstellbar stufenlos von 11-19 m.

SL-Gegengewichtswagen Superlift-Mast (siehe Standard SL). Teleskoprahmen und Gegengewichtswagen für 325 t Gesamtgewicht, 4 Räder / 2 Achsen (angetrieben und gelenkt – voll manövrierbar in Fahrzuständen Drehen, Hinterherfahrt und Nachlauf). Superlift-Gegengewicht 40-325 t auf Gegengewichtswagen mit festem Mastradius ca. 16 m; stufenlos einstellbar von 13-17 m bzw. 17-19 m mit Teleskoprahmen. Der Gegengewichtswagen erlaubt Fahren und Drehen, auch wenn das Superliftgegengewicht nicht vom Boden abhebt (Beispiel: Kran mit Last am Haken bei Tabellenwerten in Klammern).

Seilwinde H3 Zusätzliche Seilwinde im Hauptausleger (zum Betrieb an LF oder Runner), Seilzug wie H1, Länge 650 m.

Runner Max. Traglast 54 t. Montage auf Auslegerkopf und Ausleger-/Hilfsauslegerspitze. Betrieb durch Hubseil 3 (siehe Variabler SL).

Runner für LF serienmäßig Max. Traglast 18 t. Betrieb durch Hubseil 3.

Spezieller LF-Anlenkkopf Ohne Rollensatz für höhere Tragfähigkeiten am LF.

3 m-Zwischenstück Für 3 m-Zwischenlängen.

Châssis à chenilles

| | |
|-----------------------------------|---|
| | Le châssis à chenilles consiste en trois parties – deux chenilles et la partie centrale. Les chenilles et la partie centrale sont verrouillées hydrauliquement facilitant ainsi le montage et le démontage pour diminuer la largeur d'encombrement et le poids de transport. Largeur de chenille : 8,40 m. |
| Partie central | Construction mécano-soudée, rigide à la flexion et à la torsion, sous forme de caissons en acier de construction de haute résistance à grains fins. |
| Chenilles | Construction mécano-soudée rigide à la flexion, réalisée en acier de construction de haute résistance à grains fins. Graissage centralisé automatique inclus de série. Chaque chenille est équipée de 16 galets d'appui dont les surfaces de roulement sont trempées. Position rehaussée pour les barbotins d'entraînement et les roues folles, garantes de la capacité de charge pendant le relevage, tension des chenilles réglable. Patins de chenilles : 1,50 m de large. |
| Entraînement des chenilles | Les chenilles sont entraînées par un moteur hydraulique de chaque côté, muni de réducteurs planétaires sous bain d'huile, en carter étanche, avec freins d'arrêt à commande par ressorts, à desserrage hydraulique. Grâce à leur faible encombrement, les réducteurs s'intègrent complètement dans la largeur des chenilles. Chaque chenille permet un mouvement individuel et opposé. Force de traction : 1400 kN par côté. |
| Vérin de montage | Quatre vérins de montage hydrauliques sur la partie centrale (repliable sans excéder la largeur de 3 m) pour un assemblage aisé des chenilles. |

Partie supérieure

| | |
|---|--|
| Contrepoids | Contrepoids de 205 t (max. 225 t) sur la tourelle, en combinaison avec 50 t de lest central. Structure d'acier caissonnée pleine. Poids des blocs de contrepoids : 10 t. |
| Poids total | Env. 390 t, avec 165 t de contrepoids, flèche de 24 m SH_1 et crochet. |
| Vitesse de translation sur chenilles | 1,1 km/h maximum. |
| Tambour de mouflage | Monté sur la partie tournante. |
| Charpente | Structure mécano-soudée résistante à la torsion, en acier grain fin haute résistance. |
| Couronne d'orientation | Couronne d'orientation à trois rangées de rouleaux avec couronne dentée externe pour une maintenance simplifiée. Graissage automatique centralisé. |
| Entraînement | Boîte de transfert à cinq pompes à pistons axiaux à débit variable et pompes à engrenage auxiliaires. Silencieux avec pare-étincelle. Capot d'isolation sonore. Moteur diesel Mercedes-Benz, type OM 471 LA, 6 cylindres. Puissance : 390 kW (523 HP) à 1700 tr/mn, couple de 2460 Nm à 1300 tr/mn chacun. Le moteur satisfait au norme EU Stage IV / EPA Tier 4f en matière d'émissions. Le système est équipé d'un convertisseur catalytique Ad-Blue et RCS. En option pour les marchés non-régulés : Moteur diesel Mercedes-Benz, type OM 502 LA, 8 cylindres. Puissance : 405 kW (543 HP) à 1800 tr/mn, couple de 2600 Nm à 1300 tr/mn chacun. Le moteur satisfait au norme EU Stage III A / EPA Tier 3 en matière d'émissions. Réservoir de carburant : 1217 l. |
| Treuil | L'équipement standard de la partie tournante inclut trois tambours – treuil no 1, treuil no 2 et mécanisme de relevage. Les tambours sont entraînés par des moteurs hydrauliques munis de réducteurs planétaires, sous bain d'huile, en carter étanche. Tous les tambours sont dotés de freins multidisques à commande par ressort et desserrage hydraulique et disposent d'une fonction de freinage hydraulique inusable pour l'abaissement de la charge. Les pattes de câble H 1, 2, 3 et W 1, 2 sont équipées des attaches à jonction rapide. Tous les treuils sont démontables pour diminuer le poids de transport. |
| Chevalet | Systèmes de relevage hydraulique de série. Le chevalet, le treuil de relevage et les jeux de poulies pour le treuil de relevage peuvent être démontés en un seul bloc pour minimiser le poids au transport. Démontage des treuils 1 et 2 possible sans dépose préalable du chevalet. |
| Mécanisme d'orientation | Entraînée par des moteurs hydrauliques munis de 2 réducteurs planétaires, sous bain d'huile, en carter étanche. Freins d'arrêt à commande par ressort, à desserrage hydraulique et freinage hydraulique inusable. Vitesse d'orientation variable en continu entre 0 et 1 tr/min. |
| Commande | IC-1 : Commande à électrovanne proportionnelle intégrée dans le système de commande par programme enregistré avec système de diagnostic. 2 écrans couleurs, contrôleur d'état de charge actionné par écran tactile. Les vitesses de travail sont réglées sans paliers par la position du levier. Commande automatique pour une exploitation optimale de la puissance moteur ; systèmes de commande d'urgence. Fonctions additionnelles : <ul style="list-style-type: none"> • Position variable en continu du contrepoids superlift avec système superlift réglable en option entre 11-19 m • Angle variable en continu de la flèche principale en configuration SWSL 55-87° (65-87° en configuration SW) • Limitation de la zone de travail • Diagnostic et dépannage • Mode manipulateur réglable en fonction de l'utilisateur Position ergonomique des manipulateurs de commande dans la cabine du grutier. Commande à distance pour le montage. Commande d'urgence à distance sans fil. |
| Cabine | Cabine confortable avec large pare-brise et climatisation. Vitrage de sécurité panoramique, lucarne, chauffage à air autonome, tableau de bord avec l'ensemble des organes de commande et instruments de contrôle. Siège opérateur à réglage continu, siège de secours, nombreux rangements, prise 12 V. La cabine peut être inclinée vers l'arrière, pour une meilleure visibilité sur la flèche. Un système de caméras vidéo permet de surveiller les tambours. Ouverture possible du pare-brise avant. Tableau de bord réglable pour une ergonomie et une visibilité optimales. Essuie-glace avant avec position d'arrêt hors de la vitre pour une meilleure visibilité. La cabine pivote hydrauliquement pour se ranger devant la partie tournante et minimiser la largeur lors des transports. |
| Installation électrique | Système 24 V DC (2 batteries 12 V / 200 Ah). |
| Dispositif de sécurité | Contrôleur d'état de charge intégré dans la commande IC-1 (état de charge, rayon, angles, surveillance moteur et hydraulique), interrupteur de fin de course des treuils et pour les mouvements de la flèche, vérin anti-retour de flèche hydraulique, feu de position, anémomètre. |

Combinaisons de flèche

Voir page 14-21.

Equipements optionnels

Connexion rapide hydraulique

Patins de chenilles 2,0 m.

Quatre roues motrices 2 entraînements pour chaque train de chenilles : force de traction de 2600 kN, à vitesse réduite.

Contrepoids alternatifs en fonte

Répartition des contrepoids alternatifs

10 t + 7,5 t ou 10 t + 15 t

Vérin hydraulique sur chevalet Pour montage autonome du châssis à chenilles.

Vérin hydraulique avec ou sans groupe hydraulique Pour boulonnage de la flèche.

Système de stabilisateurs latéraux Complémentaires pour le montage de longs systèmes de flèche.

Kit Boom Booster

Intègre deux sections d'adaptateur de 12 m et jusqu'à 7 intercalaires de 12 m.
Longueurs disponibles : 24 m, 48 m, 60 m, 84 m, 108 m.
Extension du mât Superlift de 36 m à 39,5 m ou 42 m.

Option Flex Frame

Positionnement illimité du contrepoids de la Superlift entre 13 et 21 m.

Plateau Split Tray

Plateau avec plateforme amovible située sous la pile de contrepoids centrale de la Superlift (poids maximal des contrepoids : 125 t).

Standard SL

Mât 36 m superlift incl. treuil W2.
Tirants SL, vérin anti-retour du mât, panier SL.
Contrepoids superlift 0 t à 9 m de rayon ou 0-325 t sur panier de contrepoids avec rayons fixes de 11 m, 13 m, 15 m, 17 m et 19 m.

SL variable

Mât superlift 36 m variable (voir SL standard).
Vérins hydrauliques verticaux additionnels et treuil de stabilisation sur la partie tournante (prévient le balancement du contrepoids, surtout pendant les déplacements et l'orientation). Compensation de la hauteur via les vérins, levage par-dessus les obstacles possibles jusqu'à un certain point. Contrepoids superlift 0 t à 9 m de rayon ou 0-325 t sur panier de contrepoids avec rayons variable en continu entre 11 m et 19 m.

Chariot de contrepoids SL

Mât superlift (voir standard SL). Structure télescopique et chariot de contrepoids pour un poids total de 325 t avec 4 roues / 2 essieux (moteurs et directeurs – grande manœuvrabilité en déplacement circulaire, traction et modes parallèle). Contrepoids superlift 40-325 t sur chariot avec rayon de mât fixe de 16 m environ ; réglable en continu à 13-17 m ou 17-19 m resp. avec structure télescopique. Le chariot de contrepoids permet le déplacement ou l'orientation même avec le contrepoids superlift maintenu au sol (par ex. grue avec charges au crochet pour les valeurs entre parenthèses dans le tableau de charges).

Treuil H3

Treuil additionnel pour flèche principale (pour configuration LF ou potence), traction du câble équivalente à H1, longueur 650 m.

Potence

Capacité max. 54 t. Montée en tête de flèche et en pointe de flèche / fléchette. Utilisation avec câble de treuil 3 (voir SL variable).

Potence pour LF standard

Capacité de levage max. 18 t. Actionnement par câble 3.

Tête de tringlerie LF spéciale

Sans jeu de poulies pour des capacités de levage supérieures en configuration LF.

Segment intermédiaire de 3 m

Pour longueurs intermédiaires de 3 m.

Carro cingolato

| | |
|---------------------------------|---|
| | Carro in 3 sezioni, comprendente la carrozzeria e due cingoli. Le giunzioni idrauliche a spina tra cingoli e carro facilitano le operazioni di montaggio e smontaggio e consentono di ridurre al minimo la larghezza e il peso in ordine di marcia. Larghezza cingolo: 8,40 m. |
| Carrozzeria | Struttura saldata e scatolare, resistente a torsioni e flessioni, realizzata in acciaio strutturale ad alta resistenza a grana fine. |
| Cingoli | Struttura saldata resistente a flessioni, realizzata in acciaio strutturale pregiato a grana fine. La dotazione di serie comprende il sistema di lubrificazione centralizzato. 16 rulli portacingolo su ciascun telaio con superficie di rotolamento bonificata. Posizione rialzata per le ruote motrici e tendicingolo. Le due ruote assicurano la capacità portante necessaria per l'erezione del braccio e consentono di regolare il tensionamento dei cingoli. Pattini dei cingoli: larghezza 1,50 m. |
| Azionamento cingoli | I cingoli sono azionati da un motore idraulico ciascuno, provvisto di riduttori planetari in bagno d'olio, muniti di carter a tenuta e freno di arresto a molla, ad apertura idraulica; il design dei riduttori è estremamente compatto e si adatta perfettamente alla larghezza dei cingoli. Ogni lato è controllato a regolazione continua, con possibilità di movimento indipendente e di rotazione in direzioni opposte. Sforzo di trazione: 1.400 kN per lato. |
| Martinetti per montaggio | Quattro cilindri idraulici di sollevamento sulla carrozzeria (ripiegabili entro una larghezza di 3 m) per facilitare il montaggio dei cingoli. |

Torretta

| | |
|--------------------------------------|--|
| Contrappeso | 205 t (max. 225 t) in combinazione con una zavorra centrale da 50 t. Tipo in blocchi d'acciaio pieno. Peso dei blocchi di contrappeso: 10 t. |
| Peso totale | Circa. 390 t, incl. contrappeso 165 t, braccio 24 m SH_1 e bozzello. |
| Velocità di marcia su cingoli | Max. 1,1 km/h. |
| Verricello di avvolgimento | Montato su torretta. |
| Struttura | Struttura saldata resistente a torsioni, realizzata in acciaio strutturale ad alta resistenza a grana fine. |
| Ralla | Ralla con cuscinetto a tre file di rulli, con corona esterna per facilità di manutenzione. Impianto di lubrificazione centralizzata. |
| Azionamento | Riduttore di distribuzione per cinque pompe a pistoni assiali a cilindrata variabile e pompe a ingranaggi. Marmitta con parascintille. Rivestimento insonorizzante. Motore diesel Mercedes-Benz tipo OM 471 LA, a 6 cilindri. Potenza erogata: 390 kW (523 HP) a 1700 giri/min, coppia di 2460 Nm a 1300 giri/min ciascuno. Il motore è conforme alle norme standard per le emissioni EU Stage IV / EPA Tier 4f. Il sistema è dotato di Ad-Blue e convertitore catalitico SCR. Opzionale per mercati non regolamentati: Motore diesel Mercedes-Benz tipo OM 502 LA, a 8 cilindri. Potenza erogata: 405 kW (543 HP) a 1800 giri/min, coppia di 2600 Nm a 1300 giri/min ciascuno. Il motore è conforme alle norme standard per le emissioni EU Stage III A / EPA Tier 3. Capacità del serbatoio: 1217 l. |
| Tamburi avvolgimento fune | La dotazione standard della torretta comprende tre tamburi: argano 1, argano 2 e argano del braccio. I tamburi sono azionati da motori idraulici tramite riduttori planetari in bagno d'olio, dotati di carter a tenuta. Tutti i tamburi sono equipaggiati di freni multidisco a molla, ad apertura idraulica e sistema di frenatura idraulica antiusura per la discesa del carico. Le cime delle funi H 1, 2, 3 e W 1, 2 sono dotate di dispositivo a sgancio rapido. Tutti gli argani sono rimovibili, per minimizzare il peso durante il trasporto. |
| Cuspide | Sistemi di sollevamento idraulico per la cuspide di serie. La cuspide, l'argano del braccio e la serie di pulegge possono essere smontate e trasportate come una singola unità, per minimizzare il peso durante il trasporto. Possibilità di smontaggio degli argani 1 e 2 senza richiedere la rimozione della cuspide. |
| Ralla | Azionata da motori idraulici tramite 2 riduttori planetari in bagno d'olio, dotati di carter a tenuta. Freni di arresto a molla, frenatura idraulica antiusura, con apertura idraulica. Velocità ralla a regolazione continua 0-1 giri/min. |
| Sistema di comando | IC-1: Valvola di regolazione proporzionale elettronica integrata nel sistema di controllo software, comprendente sistema di diagnostica. 2 monitor a colori, limitatore di carico con touch-screen. Velocità di lavoro a regolazione continua sulla base della posizione della leva. Controllo automatico dell'alimentazione, per un utilizzo ottimale della potenza erogata dal motore; sistemi di controllo di emergenza. Funzioni aggiuntive: <ul style="list-style-type: none"> • Posizionamento a regolazione continua del contrappeso Superlift con sistema Superlift opzionale regolabile 11-19 m • Posizionamento a regolazione continua dell'inclinazione del braccio base in configurazione SWSL 55-87° (65-87° in configurazione SW) • Limitazione dell'area di lavoro • Diagnostica e individuazione dei guasti • Modalità joystick definita dall'utente La gru è controllata mediante leve a joystick ubicate in posizione ergonomica nella cabina della gru. Comando wireless per attrezzamento. Comando wireless per emergenza. |
| Cabina | Comoda cabina con ampio parabrezza e climatizzazione. Vetratura di sicurezza panoramica, tettuccio apribile, riscaldatore ad aria calda indipendente, strumentazione e comandi gru completi. Sedile regolabile a piacere dall'operatore, sedile di emergenza, numerosi vani portaoggetti, presa di alimentazione 12 V. La cabina può essere inclinata per incrementare la visibilità dell'operatore sul punto di lavoro del braccio. I tamburi avvolgimento fune sono dotati di videocamera di monitoraggio. Possibilità di aprire la finestra frontale. Il cruscotto può essere regolato per massimizzare l'ergonomia e la visibilità. Tergicristallo anteriore con posizione di riposo esterna all'area del parabrezza, per massimizzare la visibilità. Per il trasporto, la cabina ruota a comando idraulico sul lato anteriore della torretta, in modo da ridurre la larghezza. |
| Componenti elettrici | Impianto 24 VCC (2 batterie 12 V / 200 Ah). |
| Dispositivi di sicurezza | Limitatore di carico integrato nel dispositivo IC-1 (supervisione momento di carico, raggio, inclinazioni, motore e monitoraggio impianto idraulico), fincorsa argano, fincorsa per movimenti braccio base, antirietro idraulico braccio, luci di posizione, anemometro. |

Combinazioni braccio

Vedere a pagina 14-21.

Equipaggiamento opzionale

Attacchi rapidi idraulici

Pattini dei cingoli 2,0 m.

Quadro-drive 2 trasmissioni per ciascun cingolo: forza di trazione 2600 KN – a velocità ridotta.

I contrappesi alternativi sono realizzati in ghisa

Composizione elementi del contrappeso alternativo 10 t + 7,5 t o 10 t + 15 t

Cilindro idraulico su cuspidi Per il montaggio automatico del carro cingolato.

Cilindro idraulico con o senza centralina idraulica Per il fissaggio a mezzo spine del braccio.

Gruppo stabilizzatori laterali aggiuntivo Per l'utilizzo di bracci di lunghezza elevata.

Kit Boom Booster Costituito da 2 sezioni di adattamento da 12 m e fino a 7 inserti da 12 m. Lunghezze disponibili 24 m, 48 m, 60 m, 84 m, 108 m. Estensione del montante Superlift da 36 m a 39,5 m o 42 m.

Flex frame Posizionamento infinito del contrappeso Superlift da 13-21 m.

Split tray Struttura del supporto Superlift con piattaforma rimovibile sotto lo stack centrale dei contrappesi (stack centrale max. 125 t)

Standard SL Montante Superlift 36 m compreso argano W2. SL: barre sospese, cilindri antiretro montante, telaio SL. Contrappeso Superlift 0 t con uno sbraccio di 9 m o 0-325 t sul telaio contrappesi con uno sbraccio fisso di 11 m, 13 m, 15 m, 17 m e 19 m.

SL variabile Montante Superlift 36 m variabile (vedere SL standard). Cilindri idraulici verticali aggiuntivi e argano di stabilizzazione sulla torretta (impediscono l'oscillazione del contrappeso, in particolare durante gli spostamenti su strada e le manovre di rotazione). Compensazione altezza mediante cilindri, sollevamento con superamento di ostacoli possibile in una certa misura. Contrappeso Superlift 0 t con uno sbraccio di 9 m o 0-325 t sul telaio contrappesi, con sbraccio variabile da 11 m a 19 m.

Supporto contrappesi SL Montante Superlift (vedere SL standard). Telaio telescopico e supporto contrappesi per un peso totale di 325 t, con 4 ruote / 2 assali (traente e sterzante – completa manovrabilità per rotazione, traino e modalità di spostamento parallele). Contrappeso Superlift 40-325 t su supporto contrappesi con sbraccio montante fisso di circa 16 m; regolazione continua da 13 a 17 m o da 17 a 19 m o con telaio telescopico. Il supporto contrappesi consente il trasporto su strada o la rotazione, anche con contrappeso Superlift non sollevato da terra (si applicano i carichi indicati tra parentesi nel diagramma di carico della gru).

Argano H3 Argano aggiuntivo per braccio base (per l'uso di LF o del runner), tiro come H1, lunghezza 650 m.

Runner Capacità max 54 t. Montato su testa braccio ed estremità falcone / braccio. Funzionamento mediante fune argano 3 (vedere SL variabile).

Runner per LF standard Capacità max. di sollevamento 18 t. Azionato mediante la fune 3.

Testa tirante LF speciale Senza kit pulegge per una maggiore capacità di sollevamento quando si utilizza LF.

Sezione intermedia di 3 m Per lunghezze intermedie di 3 m.

Chasis de orugas

| | |
|------------------------------------|---|
| | Chasis de 3 secciones, formado por un cuerpo central y dos orugas. La conexión con pernos hidráulicos entre las orugas y el cuerpo central aseguran un fácil montaje y desmontaje, reduciendo al mínimo la anchura y el peso para su transporte. Ancho de oruga: 8,40 m. |
| Cuerpo central | Estructura soldada resistente a la flexión y a la torsión de construcción tipo cajón, fabricada de acero estructural de grano fino y alta resistencia. |
| Orugas | Estructura soldada resistente a la flexión, fabricada con acero de construcción de grano fino y alta resistencia. Lubricación centralizada automática incluida de serie. 16 rodillos en cada bastidor lateral con superficies de rodadura endurecidas. Posición elevada para los piñones de transmisión y las ruedas intermedias, los cuales proporcionan capacidad de soporte de carga para elevación; tensión de oruga regulable. Eslabones de las orugas: 1,50 m de anchura. |
| Unidad motriz de las orugas | Las orugas están propulsadas por un motor hidráulico, con engranajes planetarios en cárter cerrado y baño de aceite, equipadas con frenos de parada accionados por muelle y soltados hidráulicamente; los engranajes tienen un diseño extremadamente compacto para caber dentro de la anchura de las orugas. Cada oruga es controlada en progresión continua, tanto independientemente como en direcciones opuestas. Esfuerzo de tracción: 1400 kN por cada lado. |
| Gatos de montaje | 4 gatos hidráulicos en el cuerpo central (replegado en una anchura de 3 m) para un montaje sencillo de las orugas. |

Superestructura

| | |
|---|---|
| Contrapesos | Contrapeso de 205 t (máx. 225 t) en combinación de superestructura con lastre central de 50 t. Tipo cajón de acero relleno. Peso de los bloques de contrapeso: 10 t. |
| Peso total | Aprox. 390 t, incl. contrapeso de 165 t, pluma de 24 m SH_1 y bloque de gancho. |
| Velocidad de desplazamiento sobre orugas | Máx. 1,1 km/h. |
| Cabestrante pasador | Montado en la superestructura. |
| Bastidor | Estructura soldada resistente a la torsión, fabricada de acero de estructural de grano fino y alta resistencia. |
| Anillo de giro | Anillo de giro con rodamientos de tres hileras de rodillos, con corona dentada externa para una fácil reparación y mantenimiento. Sistema central de lubricación. |
| Tracción | Caja de engranajes de distribución de bombas con cinco bombas de pistón axial de desplazamiento variable y bombas de engranajes. Silenciador con parachispas. Cubierta con aislamiento acústico. Motor diésel Mercedes-Benz de 6 cilindros, tipo OM 471 LA. Potencia: cada uno 390 kW (523 HP) a 1700 rpm, par motor 2460 Nm a 1300 rpm. El motor cumple con los reglamentos norma de emisión EU Stage IV / EPA Tier 4f. El sistema está equipado con Ad-Blue y un convertidor catalítico SCR. Opcional para mercados no regulados: Motor diésel Mercedes-Benz de 8 cilindros, tipo OM 502 LA. Potencia: cada uno 405 kW (543 HP) a 1800 rpm, par motor 2600 Nm a 1300 rpm. El motor cumple con los reglamentos norma de emisión EU Stage III A / EPA Tier 3. Capacidad del depósito de combustible: 1217 l. |
| Tambores de cable | El equipamiento de serie de la superestructura incluye tres tambores de cable: cabestrante 1, cabestrante 2 y cabestrante de pluma. Los tambores son accionados por motores hidráulicos a través de engranajes planetarios en cárter cerrado y baño de aceite. Todos los tambores de cable tienen frenos multidisco accionados por muelle y soltados hidráulicamente, y frenado sin desgaste para reducir el peso. Los extremos de los cables H 1, 2, 3 y W 1, 2 están equipados con accesorios de conexión rápida. Todos los cabestrantes pueden ser desmontados para minimizar el peso de transporte. |
| Caballote | Sistema hidráulico de elevación para caballote de serie. El caballote, el cabestrante de pluma y los juegos de poleas para cabestrante de pluma pueden desmontarse como una sola unidad de transporte para minimizar el peso de transporte. Es posible desmontar los cabestrantes 1 y 2 sin retirar primero el caballote. |
| Mecanismo de giro | Accionado por dos motores hidráulicos a través de engranajes planetarios en cárter cerrado y baño de aceite. Frenos accionados por muelle y soltados hidráulicamente, así como frenado hidráulico sin desgaste. Velocidad de giro en progresión continua de 0-1 rpm. |
| Sistema de control | IC-1: Control piloto electrónico de válvulas proporcionales integrado en un sistema de control por programa almacenado, incl. sistema de diagnóstico. 2 monitores con pantallas a color, indicador de momento de carga operado mediante una pantalla táctil. Velocidades de trabajo controladas en progresión continua por la posición de la palanca. Control automático de potencia para un aprovechamiento óptimo de la potencia del motor; sistemas de control de emergencia. Funciones adicionales: <ul style="list-style-type: none"> • Posición del contrapeso Superlift variable en progresión continua con el sistema opcional Superlift ajustable de 11 a 19 m • Posición del ángulo de la pluma principal variable en progresión continua en configuración SWSL 55-87° (65-87° en configuración SW) • Limitación del área de trabajo • Diagnóstico y resolución de problemas • Modo de joystick definido por el usuario La grúa se controla mediante palancas de joystick ergonómicamente colocadas en la cabina. Control remoto inalámbrico para montaje. Control remoto inalámbrico de emergencia. |
| Cabina | Confortable cabina con amplio parabrisas y aire acondicionado. Lunas de seguridad, luna en el techo, calefacción de aire caliente autónoma, instrumentos y controles completos de la grúa. Asiento del operador totalmente ajustable, asiento de emergencia, múltiples áreas de almacenamiento, toma eléctrica de 12 V. La cabina puede ser inclinada hacia atrás para mejorar la visibilidad de manejo de la pluma. Ha sido instalado un sistema de cámara para supervisar los tambores de cable. Es posible abrir la luna delantera. El cuadro de mandos puede ajustarse para una ergonomía y una visibilidad óptimas. Limpiaparabrisas delantero con posición de reposo fuera del área de la luna para una óptima visibilidad. Para su transporte, la cabina gira hidráulicamente delante de la superestructura para reducir la anchura al mínimo. |
| Equipamiento eléctrico | Sistema de 24 V (2 baterías de 12 V / 200 Ah). |
| Dispositivos de seguridad | Indicador de momento de carga integrado en el control IC-1 (momento de carga, radio, ángulos, monitorización del motor y el sistema hidráulico), interruptor limitador de elevación, interruptores limitadores para los movimientos de la pluma, estabilizadores hidráulicos dorsales de la pluma, luz de posición, anemómetro. |

Combinaciones de pluma

Véase página 14-21.

Equipamiento opcional

Conexión hidráulica rápida

Eslabones de las orugas

2,0 m.

Transmisión Quadro

2 transmisiones para cada chasis de orugas: fuerza de tracción 2600 kN – a una menor velocidad de desplazamiento.

Contrapesos alternativos hechos de hierro colado

Segmentación de contrapeso alternativo de 10 t + 7,5 t o 10 t + 15 t

Cilindro hidráulico en el caballete

Para automontaje del chasis de orugas.

Cilindro hidráulico con o sin unidad hidráulica

Para fijación de pernos de pluma.

Sistema de estabilizadores laterales

Para erigir sistemas de pluma larga.

Kit Boom Booster

Se compone de 2 secciones de adaptación de 12 m y hasta 7 insertos de 12 m. Longitudes disponibles 24 m, 48 m, 60 m, 84 m, 108 m. Extensión de mástil Superlift de 36 m a 39,5 m o 42 m.

Flex frame

Posicionamiento infinito del contrapeso Superlift de 13 a 21 m.

Bandeja Split Tray

Bastidor de bandeja Superlift con plataforma extraíble debajo de la pila central de contrapesos (pila central máx. 125 t).

SL estándar

36 m mástil Superlift incl. cabestrante W2. Barras colgantes SL, cilindros de apoyo de mástil, bandeja SL. Contrapeso Superlift de 0 t a un radio de 9 m o 0-325 t en bandeja de contrapesos a radios fijos de 11 m, 13 m, 15 m, 17 m y 19 m.

SL variable

Mástil Superlift variable de 36 m (véase SL estándar). Cilindros hidráulicos verticales adicionales y cabestrante de estabilización en la superestructura (evita que los contrapesos oscilen, especialmente en desplazamientos y giros). Compensación de altura usando los cilindros, elevación a través de obstáculos posible hasta cierta medida. Contrapeso Superlift de 0 t a un radio de 9 m o 0-325 t en bandeja de contrapesos, progresión continua de 11 m a 19 m.

Carro de contrapesos SL

Mástil Superlift (véase SL estándar). Bastidor telescópico y carro de contrapesos para un peso total de 325 t, con cuatro ruedas / 2 ejes (con tracción y dirección: maniobrabilidad completa para modos paralelo, de giro y de remolque). Contrapeso Superlift de 40-325 t en carro de contrapesos con radio de mástil fijo de aprox. 16 m; ajustable en progresión continua de 13-17 m o 17-19 m, o con bastidor telescópico. El carro de contrapeso permite la marcha y el giro incluso cuando el contrapeso Superlift no se eleva del suelo (p. ej. grúa con cargas según indicadas entre paréntesis en la tabla de cargas).

Cabestrante H3

Cabestrante adicional para pluma principal (para operar LF o runner), tracción de cable igual que H1, longitud 650 m.

Runner

Capacidad máx. de elevación: 54 t. Montado en la cabeza de la pluma y en la parte superior de la pluma / plumín. Operado por el cable de cabestrante 3 (véase SL Variable).

Runner para LF estándar

Capacidad de elevación máx. 18 t. Accionado por cable 3.

Cabezal de conexión LF especial

Sin juego de poleas para mayores capacidades de elevación cuando se empela LF.

Sección intermedia de 3 m

Para longitudes intermedias de 3 m.

Veículo sobre esteiras

Veículo transportador de 3 seções com torre de rotação e duas esteiras. Conexões por pinos hidráulicos entre as esteiras e o chassi facilitam a instalação e a retirada, diminuindo a largura e o peso para o transporte. Largura das esteiras: 8,40 m.

| | |
|----------------------------|--|
| Torre de rotação | Estrutura soldada de construção celular resistente a flexão e torção fabricada com aço estrutural de granulação fina e alta resistência. |
| Esteiras | Estrutura soldada resistente à flexão fabricada com aço estrutural de granulação fina e alta resistência. Lubrificação centralizada automática como item de série. 16 roletes em cada chassi com superfícies de rolamento temperadas. Posição elevada das engrenagens motoras e das rodas livres, todas com retesamento das esteiras ajustável para a capacidade de carga no içamento. Sapatas das esteiras: 1,50 m de largura. |
| Tração da esteira | As esteiras são comandadas por um motor hidráulico cada uma, através de caixas fechadas com engrenagens planetárias em banho de óleo, equipadas com freios de retenção com liberação hidráulica por ação de mola; as caixas têm construção bastante compacta, próprias para a largura das esteiras. Cada esteira tem controle de variação infinita, tanto em modo independente quanto em sentidos inversos. Esforço de tração: 1400 kN por lado. |
| Macacos de montagem | Quatro cilindros hidráulicos de levantamento na torre de giro (fechando com menos de 3 metros de largura) para facilitar a montagem das esteiras. |

Superestrutura

| | |
|--|---|
| Contrapeso | Contrapeso de 205 t (máx. 225 t) na superestrutura combinado com 50 t de lastro central. Tipo caixa de aço cheia. Peso dos blocos de contrapeso: 10 t. |
| Peso total | Aprox. 390 t, incl. contrapeso de 165 t, lança de 24 m SH_1 e moitão. |
| Velocidade de percurso sobre esteiras | Máx. 1,1 km/h. |
| Guincho de passagem | Montado na superestrutura. |
| Chassi | Estrutura soldada resistente à torsão fabricada com aço estrutural de granulação fina e alta resistência. |
| Anel de giro | Anel de giro com rolamento de três carreiras de rolos e coroa externa para facilidade de serviço e manutenção. Sistema de lubrificação central. |
| Tração | Caixa de engrenagens de distribuição para as bombas com cinco bombas de pistão axial com deslocamento variável e bombas de engrenagens. Silencioso com placa antifagulhas. Revestimento com isolamento sonoro. Motor a diesel de 6 cilindros Mercedes-Benz tipo OM 471 LA. Potência: 390 kW (523 HP) a 1700 rpm, torque de 2460 Nm at 1300 rpm cada. Os motores atendem os requisitos das norma de emissões EU Stage IV / EPA Tier 4f. O sistema vem com aditivo Ad-Blue e conversor catalítico SCR. Opcional para mercados não regulamentados: Motor a diesel de 8 cilindros Mercedes-Benz tipo OM 502 LA. Potência: 405 kW (543 HP) a 1800 rpm, torque de 2600 Nm a 1300 rpm cada. Os motores atendem os requisitos das norma de emissões EU Stage III A / EPA Tier 3. Capacidade do tanque de combustível: 1217 l. |
| Tambores dos cabos de aço | O equipamento padrão da superestrutura inclui três tambores para cabos de aço – guincho 1, guincho 2 e guincho da lança. Os tambores são comandados por motores hidráulicos através de caixas fechadas com engrenagens planetárias em banho de óleo. Todos os tambores contam com freios multidisco de liberação hidráulica por ação de mola e frenagem hidráulica sem desgaste para a descida das cargas. Pontas dos cabos H 1, 2, 3 e W 1, 2 equipadas com conexões de engate rápido. Todos os guinchos são removíveis para reduzir o peso durante o transporte. |
| Suporte angular | Sistemas hidráulicos de elevação do suporte angular como item de série. O suporte angular, os guinchos da lança e seus conjuntos de roldanas podem ser desmontados como unidade inteira a fim de reduzir o peso para transporte. A desmontagem dos guinchos 1 e 2 é possível sem primeiro remover o suporte angular. |
| Unidade de giro | Comandadas por motores hidráulicos através de 2 caixas fechadas com engrenagens planetárias em banho de óleo. Freios de retenção por ação de mola com liberação hidráulica e frenagem hidráulica sem desgaste. Velocidade de giro de 0 a 1 rpm infinitamente variável. |
| Sistema de controle | IC-1: Controle eletrônico proporcional do piloto da válvula integrado ao sistema de controle por programa armazenado incluindo sistema de diagnóstico. Dois monitores com tela colorida, indicador de momento de carga operado por tela de toque. Velocidades de trabalho infinitamente variáveis, controladas pela posição da alavanca. Controle automático de potência para máxima utilização do rendimento do motor; sistemas de controle de emergência. Outras funções: <ul style="list-style-type: none"> • Posição infinitamente variável do contrapeso do Superlift com sistema opcional de ajuste de 11 a 19 m • Posição infinitamente variável do ângulo da lança principal em configuração SWSL entre 55 e 87° (65 a 87° em configuração SW) • Limitação da área de trabalho • Diagnóstico e solução de problemas • Modo das alavancas de comando definido pelo usuário O guindaste é controlado por alavancas de comando ergonomicamente posicionadas na cabine. Controle remoto sem fio do içamento. Controle remoto sem fio de emergência. |
| Cabine | Cabine confortável com amplo parabrisa e ar condicionado. Vidros de segurança em toda a volta, teto solar, aquecedor de ar autônomo, instrumentação completa e controles do guindaste. Assento do operador livremente regulável, assento de emergência, vários porta-objetos, plugue elétrico de 12 V. A cabine pode ser reclinada para melhorar a visão da ponta da lança pelo operador. Há um sistema de câmera instalado para monitorar os tambores dos cabos de aço. A janela dianteira pode ser aberta. Painel regulável para melhor ergonomia e visualização. Limpador do parabrisa dianteiro com posição de descanso fora do campo visível. Para transporte, a cabine rebate hidráulicamente para a frente da superestrutura a fim de diminuir a largura. |
| Equipamentos elétricos | Sistema de 24 V (2 baterias de 12 V / 200 Ah). |
| Equipamentos de segurança | Indicador do momento de carga integrado em controle IC-1 (momento de carga, raio, ângulos, monitoração do funcionamento do motor e do sistema hidráulico), chave limitadora do guincho, chaves limitadoras dos movimentos da lança, batentes hidráulicos da lança, luz de posição, anemômetro. |

Combinações de lanças

Ver página 14-21.

Equipamentos opcionais

Conexão hidráulica de engate rápido

Sapatas das esteiras

2,0 m.

Acionamento quádruplo

2 acionadores para cada esteira: 2600 kN de força de tração em marcha reduzida.

Contrapesos alternativos feitos de ferro fundido

Segmentação dos contrapesos com alternativa de 10 t + 7,5 t ou 10 t + 15 t

Pistão hidráulico do suporte angular Para automontagem do veículo da esteira.

Pistão hidráulico com ou sem unidade hidráulica Para pinagem da lança.

Sistema estabilizador lateral adicional Para montagem de longos sistemas de lança.

Kit do extensor da lança Consiste de 2 seções adaptadoras de 12 m e até 7 suplementos de 12 m. Disponíveis para comprimentos de 24 m, 48 m, 60 m, 84 m, 108 m. Disponível para torre do Superlift de 36 m a 39,5 m ou 42 m.

Flex Frame Livre posicionamento do contrapeso do Superlift de 13 a 21 m.

Split Tray Estrutura da plataforma do Superlift com outra plataforma removível embaixo da pilha de contrapesos (pilha central máx. 125 t).

SL padrão Mastro do Superlift 36 m incl. guincho W2. Barras pendentes do SL, cilindros dos batentes da lança, base do SL. Contrapeso do Superlift 0 t em raio de 9 m ou 0 a 325 t na caixa do contrapeso com raios fixos de 11 m, 13 m, 15 m, 17 m e 19 m.

SL variável Mastro do Superlift 36 m variável (ver SL padrão). Complemento de cilindros hidráulicos verticais e guincho de estabilização na superestrutura (impede o jogo do contrapeso especialmente durante o deslocamento e o giro). Compensação da altura usando os cilindros possibilita, até certo ponto, o içamento por cima de obstáculos. Contrapeso do Superlift 0 t no raio de 9 m ou 0-325 t na caixa do contrapeso, infinitamente variável de 11 m a 19 m.

Veículo do contrapeso do SL Mastro do Superlift (ver SL padrão). Estrutura telescópica e veículo do contrapeso com peso total de 325 t, 4 rodas / 2 eixos (movido e esterçável – total capacidade de manobra em modos de giro, rebocado e paralelo). Contrapeso do Superlift 40 a 325 t sobre veículo com raio do mastro fixo de aprox. 16 m; Infinitamente ajustável entre 13 e 17 m ou 17 e 19 m com estrutura telescópica. O veículo do contrapeso permite o deslocamento e o giro mesmo quando o contrapeso do superlift não sai do chão (p.ex. guindaste com as cargas indicadas pelos valores da tabela de cargas entre parênteses).

Guincho H3 Guincho adicional para a lança principal (para operação com LF ou runner), tração no cabo igual a H1, comprimento 650 m.

Ponta de montagem (Runner) Capacidade máx. de 54 t. Instalado na cabeça da lança e no topo do conjunto principal / auxiliar. Operação por cabo de guincho 3 (ver SL Variável).

Runner para LF padrão Capacidade máx. içamento 18 t. Operado pelo cabo 3.

Cabeça de ligação à LF especial Sem conjunto de roldanas para maior capacidade de içamento durante o uso da LF.

Seção intermediária de 3 m Para comprimentos intermediários de 3 m.

Гусеничное шасси

| | |
|---------------------------|---|
| | 3-х секционное шасси, состоящее из кузова и двух гусениц. Штифтовые соединения корпуса шасси и гусениц, обслуживаемые гидравликой, обеспечивают легкость сборки и разборки для уменьшения ширины и веса при транспортировке. Ширина колеи: 8,40 м. |
| Кузов | Сварная конструкция коробчатого типа, прочная на изгиб и скручивание, изготовленная из высокопрочной мелкозернистой конструкционной стали. |
| Гусеницы | Сварная конструкция из устойчивой к изгибу высокопрочной мелкозернистой конструкционной стали. Система автоматической централизованной смазки входит в стандартную комплектацию. 16 роликов на каждой боковой раме с закаленной поверхностью качения. Подъем как ведущих звездочек так и не приводных колес, ведущие звездочки и не приводные колеса обеспечивают грузоподъемность необходимую для сборки, регулируемое натяжение гусениц. Звенья гусеничной цепи: ширина 1,50 м. |
| Привод гусениц | Каждая гусеница приводится в движение отдельным гидравлическим двигателем через планетарный редуктор в закрытом корпусе с масляной ванной, каждый снабжен подпружиненным тормозом-замедлителем с гидроусилителем. Редукторы имеют очень компактную конструкцию и не выходят за ширину гусениц. Бесступенчатая регулировка движения каждой гусеницы, отдельно и в противоположном направлении. Тяговое усилие: 1400 кН на сторону. |
| Сборочные домкраты | Четыре цилиндра гидравлических домкратов на шасси крана (складные, не выходят за параметры ширины 3 м) для облегчения сборки гусениц. |

Надстройка

| | |
|---------------------------------------|--|
| Противовес | Вес противовесов на надстройке 205 т (макс. 225 т) с учетом 50 т центрального балласта. Устанавливаются в клеточную конструкцию из стали. Вес блоков противовесов 10 т. |
| Общий вес | Прибл. 390 т, включая противовес 165 т, стрелу длиной 24 м SH_1 и крюкоблок. |
| Скорость движения на гусеницах | Макс. 1,1 км/ч |
| Запасовочная лебедка | Установлена на надстройке. |
| Рама | Сварная конструкция прочная на изгиб и скручивание, изготовленная из высокопрочной мелкозернистой конструкционной стали. |
| Опорно-поворотный круг | Опорно-поворотный круг с катковой опорой с тремя рядами подшипников качения для легкого обслуживания. Система централизованной смазки. |
| Привод | Раздаточная коробка насосов с пятью поршневыми насосами с регулированием объема и шестеренными насосами. Глушитель с искрогасителем. Шумопоглощающий кожух. дизельных 6-цилиндровых двигателя Mercedes-Benz типа OM 471 LA. Выходная мощность: 390 кВт (523 л.с.) при 1700 об/мин, вращающий момент 2460 Нм при 1300 об/мин; Двигатель соответствует требованиям стандарт выбросов EU Stage IV / EPA Tier 4f. Система оснащена топливной системой Ad-Blue с каталитическим нейтрализатором SCR. Опционально для нерегулируемых рынков: дизельных 8-цилиндровых двигателя Mercedes-Benz типа OM 502 LA. Выходная мощность: 405 кВт (543 л.с.) при 1800 об/мин, вращающий момент 2600 Нм при 1300 об/мин, каждый. Двигатель соответствует требованиям стандарт выбросов EU Stage III A / EPA Tier 3. Емкость топливного бака: 1217 л. |
| Канатные барабаны | Стандартная комплектация оборудования надстройки включает три тросовых барабана – лебедок 1 и 2 и лебедки стрелы. Барабаны приводятся в движение гидравлическими двигателями через планетарную передачу, вращающуюся в масляной ванне в закрытом корпусе. Каждый канатный барабан имеет подпружиненный многодисковый тормоз с гидроусилителем и неизнашивающийся гидравлический тормоз для опускания груза. Концы тросов для лебедок H 1, 2, 3 и W 1, 2 имеют быстроразъемные соединительные концевые фитинги. Все лебедки съемные для уменьшения веса при транспортировке. |
| A-образная рама | Гидравлическая система подъема A-образной рамы входит в стандартную комплектацию. A-образная рама, комплект шкивов для лебедки подъема стрелы снимается и перевозится одним блоком для уменьшения веса крана при перевозке. Снятие лебедок 1 и 2 возможно без снятия сначала A-образной рамы. |
| Поворотный механизм | Приводятся в движение гидравлическими двигателями через планетарную передачу, вращающуюся в масляной ванне в закрытом корпусе. Подпружиненный гидравлический тормоз-замедлитель и неизнашивающийся гидравлический тормоз. Скорость поворота надстройки с бесступенчатой регулировкой в диапазоне 0-1 об/мин. |
| Система управления | IS-1: Система электронного пропорционального управления через регулирующие клапаны, встроенная систему управления, включающую диагностическую систему. 2 монитора с цветными дисплеями, индикатор момента нагрузки, управляемый через сенсорный экран. Бесступенчатая регулировка рабочих скоростей изменением положения рычага. Автоматическая регулировка мощности для оптимизации выходной мощности двигателя; системы аварийного управления. Дополнительные функции: <ul style="list-style-type: none"> • бесступенчатая регулировка положения противовеса с регулируемой системой суперлифт 11-19 м (опция); • бесступенчатая регулировка угла наклона главной стрелы в конфигурации SWSL в пределах 55-87° (65-87° в конфигурации SW); • ограничитель рабочей зоны; • диагностика и выявление неисправностей; • заданный пользователем режим джойстика. |
| Кабина | Кран управляется с помощью рычагов джойстиков, эргономически расположенных в кабине крана. Радиопульт дистанционного управления сборкой Радиопульт аварийного управления. Комфортабельная кабина с большим ветровым стеклом и кондиционером. Безопасное остекление всех дверей и окон, потолочный люк, независимый воздушный обогреватель, полный комплект приборов и органов управления краном. Сиденье оператора с бесступенчатой регулировкой, аварийное сиденье, большое количество ящиков для хранения, разъем питания 12 В. Кабина откидывается назад для лучшего обзора конца стрелы крана. Для управления канатными барабанами установлена система камер. Переднее окно открывается. Положение панели приборов регулируется, обеспечивая оптимальную эргономику и обзор. Передний стеклоочиститель ветрового стекла с позицией парковки, не закрывающей зону обзора. При транспортировке кабина вертикально откидывается перед надстройкой для сокращения ширины. |
| Электрическое оборудование | 24 В постоянного тока (2 аккумуляторных батареи 12 В, 200 Ач). |
| Дополнительные устройства | Индикатор момента нагрузки, встроенный в схему управления IS-1, (момент нагрузки, радиус, углы, контроль гидравлической системы), ограничитель лебедки, ограничители движения стрелы, гидравлический ограничитель обратного хода стрелы, позиционный фонарь, анемометр. |

Комбинации стрелы

см. на стр. 14-21.

Дополнительное оборудование

Гидравлическая система быстроразъемных соединений

Звенья гусеничной цепи 2,0 м.

Квадропривод 2 привода для каждого гусеничного шасси: 2600 кН тягового усилия – на пониженной скорости движения.

Альтернативные противовесы из чугуна

Блоки альтернативных противовесов:
10 т + 7,5 т или 10 т + 15 т

А-образная рама с гидравлическим цилиндром для самосборки гусеничного шасси.

Гидравлический цилиндр с или без гидравлического блока для штифтовой сборки стрелы.

Дополнительная система выдвигаемых опор

для сборки систем с длинными стрелами.

Комплект усилителя стрелы Boom Booster

Состоит из 2 переходных секций по 12 м и до 7 удлинительных секций по 12 м. Варианты длины: 24 м, 48 м, 60 м и 84 м, 108 м. Возможность удлинения мачты Superlift с 36 м до 39,5 м или 42 м.

Flex frame

Бесступенчатое позиционирование противовеса Superlift в диапазоне 13-21 м.

Платформа Split Tray

Платформа для противовесов Superlift с возможностью удаления платформы из под центрального штабеля противовесов (вес центрального штабеля максимум 125 т).

Стрела Standard SL

36 м с мачтой Superlift вкл. лебедку W2.

Растяжки системы подвески SL, цилиндры заднего упора мачты, платформа тягача для перевозки противовесов SL. Противовес superlift 0 т при радиусе 9 м или 0-325 т платформе тягача для перевозки противовесов при фиксированных радиусах 11 м, 13 м, 15 м, 17 м и 19 м.

SL с бесступенчатой регулировкой

Мачта Superlift 36 м с бесступенчатой регулировкой (см. стрелу Standard SL).

Дополнительные гидравлические цилиндры вертикального подъема и стабилизирующая лебедка на надстройке (предотвращает колебания противовесов особенно при транспортировке и вращении). Компенсация высоты при помощи этих цилиндров, подъем через препятствия возможен в ограниченной степени. Противовес superlift 0 т при радиусе 9 м или 0-325 т на платформе тягача для перевозки противовесов при бесступенчатой регулировке радиуса в диапазоне 11-19 м.

Тягач с платформой для перевозки противовесов SL

мачта Superlift (см. стрелу Standard SL). Телескопической рама и тягач с платформой для перевозки противовесов, рассчитанная на общий вес 325 т, с 4 колесами / 2 осями (ведущая и рулящая – обеспечивающие полную маневренность при вращении, буксировке и движении в параллельном режиме). Противовес Superlift 40-325 т на платформе тягача для перевозки противовесов с фиксированным радиусом около 16 м; с бесступенчатой регулировкой 13-17 м или 17-19 м соответственно с телескопической рамой. Тягач с платформой для перевозки противовесов позволяет перемещение или разворот шасси крана, даже не поднимая противовес superlift с земли (т.е. крана с поднимаемым весом, указанном в таблице нагрузок в скобках).

Лебедка H3

дополнительная лебедка для главной стрелы (для работы со стрелой LF или подвижным блоком), тяговое усилие на тросе то же, что и на лебедке H1, длина 650 м.

Подвижной блок

Макс. грузоподъемность 54 т. Устанавливается на головке стрелы или на верхней секции главной/вспомогательной стрелы. Управление с помощью троса лебедки 3 (см. SL с бесступенчатой регулировкой).

Подвижной блок для стандартной стрелы LF

Макс. грузоподъемность 18 т. Управляется тросом 3.

Специальная

без шкива, устанавливается для увеличения грузоподъемности при работе со стрелой LF.

Промежуточная секция 3 м

Для 3-метровых промежуточных удлинителей.

Notes

CC 3800-1

Notizen · Notes · Nota · Notas · Notas ·
пометы, комментарии, примечания

A large rectangular area with horizontal lines, intended for taking notes.

Notes

CC 3800-1

Notizen · Notes · Nota · Notas · Notas ·
пометы, комментарии, примечания

A large rectangular area with horizontal lines, intended for taking notes.

October 2019. Product specifications and prices are subject to change without notice or obligation. The photographs and/or drawings in this document are for illustrative purposes only. Refer to the appropriate Operator's Manual for instructions on the proper use of this equipment. Failure to follow the corresponding Operator's Manual when using our equipment or to otherwise act responsibly may result in serious injury or death. The only warranty applicable to our equipment is the standard written warranty applicable to the particular product and sale and Demag makes no other warranty, express or implied. All rights reserved. Products and services listed may be trademarks, service marks or trade-names of Demag IP Holdings GmbH.

Oktober 2019. Irrtum und Änderungen der Produktspezifikationen vorbehalten. Die in diesem Dokument enthaltenen Fotos und/oder Zeichnungen dienen rein anschaulichen Zwecken. Für den sachgemäßen Gebrauch der Maschinen ist das entsprechende Bedienerhandbuch heranzuziehen. Unsachgemäßer Umgang mit bzw. unsachgemäßer Einsatz unserer Maschinen kann zu schweren gesundheitlichen Schäden bis hin zum Tod führen. Für unsere Produkte wird ausschließlich die entsprechende, schriftlich niedergelegte Standardgarantie gewährt. Demag leistet keinerlei darüber hinausgehende Garantie, weder ausdrücklich noch stillschweigend. Alle Rechte vorbehalten. Die genannten Produkte und Dienstleistungen sind ggf. Marken, Dienstleistungsmarken oder Handelsnamen der Demag IP Holdings GmbH.

Octobre 2019. Les caractéristiques et prix des produits peuvent faire l'objet de modifications sans notification préalable. Les photographies et/ou schémas présentés dans le présent document sont communiqués à titre purement informatif. Pour connaître les instructions relatives à l'utilisation correcte de cet équipement, veuillez vous référer au manuel de l'utilisateur correspondant. Le non-respect du manuel d'utilisateur correspondant lors de l'utilisation de notre équipement ou des actes irresponsables risquent de provoquer de graves blessures, voire un décès. La seule garantie applicable à nos équipements est la garantie écrite standard applicable au produit et à la vente spécifiques. Demag ne délivre aucune autre garantie, expresse ou implicite. Tous droits réservés. Les produits et les services mentionnés peuvent être des marques de commerce, des marques de service ou des appellations commerciales de Demag IP Holdings GmbH.

Ottobre 2019. Ci riserviamo il diritto di modificare le caratteristiche tecniche ed i prezzi dei prodotti in ogni momento e senza obbligo di preavviso. Le fotografie e gli schemi presentati in questo documento sono forniti unicamente a scopo illustrativo. Consulta il Manuale dell'operatore per trovare istruzioni per l'utilizzo corretto di questo macchinario. La mancata osservanza delle istruzioni contenute nel Manuale dell'operatore durante l'uso del macchinario e altri comportamenti irresponsabili possono provocare gravi lesioni, anche mortali. L'unica garanzia applicabile ai nostri macchinari è la garanzia scritta standard applicabile al particolare prodotto e alla particolare vendita e Demag non dà alcuna altra garanzia, esplicita o implicita. Tutti i diritti riservati. I prodotti e servizi elencati possono essere dei marchi di fabbrica, marchi di servizio o nomi commerciali di Demag IP Holdings GmbH.

Octubre 2019. Los precios y las especificaciones de los productos pueden sufrir cambios sin previo aviso ni obligación. Las fotografías y/o dibujos de este documento tienen un fin meramente ilustrativo. Consulte el correspondiente manual de instrucciones del operador para obtener más información sobre el uso correcto de esta maquinaria. El hecho de no respetar el correspondiente manual del operador al utilizar la maquinaria o de actuar de forma irresponsable, puede provocar lesiones graves o mortales. La única garantía aplicable a nuestra maquinaria es la garantía escrita estándar correspondiente a cada producto y venta, y Demag no amplía dicha garantía de forma expresa ni implícita. Todos los derechos reservados. Los productos y servicios mencionados pueden ser marcas comerciales, marcas de servicio o nombres de marca de Demag IP Holdings GmbH.

Outubro 2019. As especificações e os preços dos produtos estão sujeitos a alteração sem nenhuma obrigação ou prévio aviso. As fotografias e/ou desenhos neste documento são apenas para fins ilustrativos. Consulte o respectivo Manual do Operador para instruções sobre o uso correto deste equipamento. Deixar de acompanhar o respectivo Manual do Operador ao usar o nosso equipamento ou, de qualquer outra forma, deixar de agir de maneira responsável pode resultar em lesões corporais graves ou morte. A única garantia aplicável ao nosso equipamento é a garantia padrão por escrito correspondente ao produto vendido. A Demag não dá outras garantias, expressas ou implícitas. Todos os direitos reservados. Os produtos e serviços indicados podem ser marcas comerciais, marcas de serviço ou nomes comerciais da Demag IP Holdings GmbH.

Октябрь 2019 г. Технические характеристики и цены могут изменяться без предварительного уведомления и без каких-либо обязательств для производителя. Фотографии и (или) чертежи в настоящем документе служат только в качестве иллюстраций. Инструкции по надлежащей эксплуатации данного оборудования см. в соответствующем руководстве для оператора. Невыполнение указаний соответствующих руководств для оператора при эксплуатации оборудования или другие безответственные действия могут повлечь серьезные травмы или смерть. Единственной гарантией, действующей в отношении нашего оборудования, является стандартная форма письменной гарантии на данный тип оборудования и на условия его продажи. Demag не дает никаких других гарантий: ни ясно выраженных, ни подразумеваемых. Все права защищены. Перечисленные продукты и услуги могут быть товарными знаками, знаками обслуживания или торговыми наименованиями Demag IP Holdings GmbH.

© Tadano Demag GmbH 2019. Demag is a trademark of Tadano Demag GmbH.

DEMAG
TADANO GROUP

Tadano Demag GmbH
Europa Allee 2
66482 Zweibrücken
Germany
T +49 6332 830

www.demagmobilecranes.com



Tadano Ltd. (International Division)
4-12, Kamezawa 2-chome
Sumida-ku Tokyo 130-0014, Japan
E info@tadano.com T 81-3-3621-7750
www.tadano.com